

60
40 CENTS

DXing HORIZONS

TV - SHORTWAVE - FM



VOLUME ONE

NUMBER FOUR

Radio Australia Control Center - Page 9

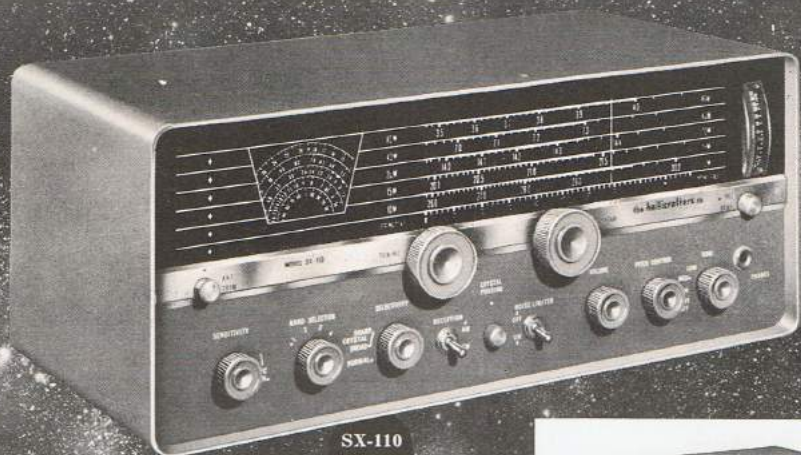

**SX-110
Receiver**

*The new ideas
in communications
are born at
Hallicrafters*

NEW: SX-110 Receiver. Advanced features and design make the SX-110 an exceptional value for the radio amateur and short wave enthusiast alike. Standard broadcast plus three short wave bands (540 kc-34 mc). Slide rule bandspread dial, calibrated for ham and citizens' bands; built-in "S" Meter, antenna trimmer, crystal filter. Seven tubes plus rectifier.

NEW: R-48 Speaker. (not shown) Perfect match for SX-110. Latest design; uses new $5\frac{1}{2}$ " x $7\frac{1}{2}$ " speaker. Exceptional damping qualities, distortion-free response. Switch for selection of voice or music response.

NEW: S-107 Receiver. Outstanding new styling and impressive features. Standard broadcast plus four short wave bands—unusually wide coverage (540 kc-34 mc and 48-54.5 mc). Separate bandspread and logging scale; slide rule dial; phono jack and headset taps. Seven tubes plus rectifier.



S-108



S-38E



S-107

NEW: S-108 Receiver. Exceptional value and performance. Same as SX-110 in frequency coverage but without "S" Meter, antenna trimmer and crystal filter. Built-in speaker. Calibrated slide rule dial; temp. compensated oscillator. Seven tubes plus rectifier. Ideal general coverage receiver.

NEW: S-38E Receiver. Latest version of the world's most popular short wave receiver. Modern new styling, improved circuitry for utmost in performance and dependability. Standard broadcast plus three short wave bands (540 kc-32 mc). Electrical bandspread; slide-rule overseas dial; headset output; built-in speaker.

hallicrafters
Company

At Sign Off

BROADCAST BAND DX

DX enthusiast Raymond S. Moore said, "It is my opinion that the most skilled and devoted DX listeners in the world operate on the Medium Wave BCB." But he wasn't alone. Letters too numerous to count have cascaded into this office asking that DXH include a BCB DX section. We are pleased . . . happy . . . enthused and just plain jubilant to announce BCB DXer EXTRAORDINAIRE (and a member of the AM BCB profession), JOHN CALLARMAN of CANYON, TEXAS, is now heading up our BCB department. Like the shortwave dept., it will involve a great deal of planning between now and its first month in print, currently tagged for July. Suffice to say Callarman at 2411 11th Ave., Canyon, Texas will need lots of help!

MILLION WATT FM STATION

Better cut back on the RF gain control when you approach 93.7 megacycles! WFSM, Birmingham, Alabama has applied to the FCC for permission to radiate 1,000,000 watts ERP from a 16 bay antenna, driven by two 35 kW GE transmitters.

ALL UHF?

Don't look now but FCC decision made in early March to make Central Valley of California all UHF (including Fresno and Bakersfield markets) may be spearheading a mass move to create many other ALL UHF AREAS . . . all of which we believe is preliminary to FCC announcing some day soon (at least before 1963!) that UHF can serve as well as VHF! California move to UHF shows FCC NOW BELIEVES VHF shoehorning will not work, and that the military has no intention of freeing added VHF spectrum space. Fresno and Bakersfield now have one VHF and two UHF each. Pending the usual legal battles, "V's" will be packed up and moved into "U's."

AND . . .

Legislation pending in Senate (S.3115) would make it mandatory that all manufacturers of TV sets be required to use VHF-UHF combo tuners. The industry of course opposes the bill (sponsored by Sen. Pastore, D., R.I.), claiming costs of UHF tuner prohibitive for receivers in VHF only areas. But the FCC, we learn, is behind this bill. "Another indication of gradual swing to all UHF?" Could be the FCC has made up its mind even without the proposed NYC UHF test described last month.

TWO-TWOS

FCC has apparently decided, following court ruling on the case, that KTVI grant in St. Louis is illegal. Look for Channel 2 St. Louis to be returned to Springfield, Illinois, by court order!

Channel 2 drop in (well . . . almost) at Terre Haute, Indiana was filed for by existing WTHI-10. WTHI operation on Channel 2 (from 10) WAS EXPECTED weekly. Now opposing group (Illiana Telecasting Corp.) has filed court hold order, and WTHI will have to stay with 10 temporarily, until legalities are straightened out.

JERROLD ON THE MARCH?

Jerrold Company, original supplier of community cable TV equipment in early 50's, and now one of the largest owners of TV cable companies, has

been instrumental in developing new LINE AMPLIFIERS in the Toronto pay TV experiment. It now appears Jerrold may join forces with Muzak Corp. to make use of existing TV cable systems to develop a TV cable network for programming to the estimated 2.2 million people served via cabled TV. It is an interesting thought . . . a feature film, special events network?

CANADIANS AT WORK

First FM network in Canada goes into operation early in April when CBC-FM, Toronto (99.1), CBO-FM, Ottawa (103.3), and CBM-FM, Montreal (95.1), begin Monday through Friday hookup in the early evening hours. All programming will be in English, although network identification will be French and English, to start the evening's activities.

To date only operating TV stations in Canada are CBC, EXCEPT CFRN (3-Edmonton) and CHCT (2-Calgary). BBC hearings relative to opening a new channel in each of these cities for TV this spring finds the CBC in the running for the Edmonton application where five groups have applied. Edmonton hearing is scheduled for May 9.

A new relay on Channel 5 in Pembroke, Ontario (100 miles north of Ottawa) will relay CBOT English programs according to CBC. No power is mentioned, although the relay's tower will be 300 feet above ground.

NBC SWITCH DUE IN 'FRISCO

The papers are signed, KTVU (2-Oakland) now belongs to the folks at NBC, unless the FCC decides not to approve a part of the complex sale-buy. Current NBC outlet in S.F. is KRON-4. It is expected NBC will wish to switch their net programming to their own station, KTVU. KRON says they will fight any such move.

13 FOR ROCHESTER?

WVET-WHEC share timers on Channel 10, Rochester are at it tooth and nail. Both want an outlet of their own. WVET proposes Channel 13 be DROPPED in Rochester, for an educational channel, and it (WVET) offers to install and pay for operation of 13 educational channel. If it (WVET) is not using Channel 10 (when WHEC is!) Currently WVET-WHEC split time on Channel 10. The Rochester educational group reportedly is in favor of having WVET install a station for them even if they are only able to use it half the time. FCC however may not be so exuberant over share time commercial-educational outlet on same channel.

ANOTHER UHF POCKET . . . IN CONNECTICUT?

WWLP-22, highly successful UHFer in the Connecticut Valley has petitioned the FCC that WTIC-3, Hartford, be required to move to UHF channel to make area virtually all UHF.

CONELRAD—MAY 3

A 30 minute drill from 1300-1330 EST (1200-1230 CST, 1100-1130 MST, 1000-1030 PST) will empty the AM, FM and TV airwaves of all signals except clamor at 640 and 1240 kc AM. An excellent chance to look for daytime Canadian and Cuban reception on all three bands.

FCC JUST DID IT!

NEW TV GRANTS:

Clearwater, Florida—Channel 32, 9 kW, 300 foot antenna.

Ogden, Utah—Channel 18, Educational, 450 watts.

DXing HORIZONS

"A monthly publication devoted to active Shortwave listeners and Television-FM long range enthusiasts throughout the world. DXing HORIZONS is the copyright title of Robert B. Cooper, Jr., registered 1960."

"DXing HORIZONS is compiled for the 100,000 active Shortwave listeners, 25,000 weak signal long range TV-FM enthusiasts, and the 3,000 operators of TV translators, VHF boosters, and master distribution systems. Advertising rate card upon request. DXing HORIZONS accepts advertising from bona fide manufacturers and distributors of new electronic equipment, parts and assemblies. *DXing HORIZONS is the only magazine in its field . . . readership interest and acceptance guaranteed.*"

DXing HORIZONS

P. O. Box 3150
Modesto, California

Publisher-Editor

Robert B. Cooper, Jr.
(Amateur K6EDX)

Circulation Manager

Carole Buchanan

Shortwave Editor

Kenneth R. Board
948 Stewartstown Road
Morgantown, West Virginia

FM Editor

Bruce F. Elving
920 Laramie Street
Manhattan, Kansas

Every effort is made to assure the authenticity of material appearing in DXing HORIZONS. The publisher cannot be responsible for inaccuracies which may arise outside the normal publishing and editing duties. The staff does make every effort to enforce regulatory measures over editorial content.

All rights to material in DXing HORIZONS are reserved by the publisher. Reprint permission available on an individual request basis.

SUBSCRIPTION INFORMATION

Canadian-U.S.A. Rates:

One Year.....\$ 4.00
Two Years..... 7.00
Three Years..... 10.00

Airmail — One Year..... 7.00

Foreign Rates:

One Year..... 4.00
Two Years..... 7.50

Printed by Gowans Printing Co.
Modesto, Calif., USA

FEATURES

Page

FOR THE TV EXPERIMENTER

"The Ultimate Pre-Amp ... The 417A" . . . 3

REPORT FROM GENEVA 6

SHORTWAVE ANTENNAS (Part One)

"Care and Feeding of Long Wires" 7

SHORTWAVE STATION REPORT

"Radio Australia" 9

TELEVISION AND FM

"The Mysterious E Skip" 10

WEAK SIGNAL INDUSTRY

"Cable System Regulation Near" 16

SHORTWAVE PROFILE

"Sidney Pearce, Berkhamsted, England" . . . 28

DEPARTMENTS

AT SIGN OFF (Last Minute News) 1

TECH NOTES 12

INTERNATIONAL TV DX 13

TV DXers REPORT 14

"WORLD AT A TWIRL" (Shortwave News) . . 20

FM DXers REPORT 33

SHORTWAVE PROPAGATION 34

TV-FM FCC NEWS 35

AT FADE-OUT (Late SW News) 31

For Everyone Interested in Better
Weak Signal TV Reception . . .

DXing Horizons Builds the 417A Pre-Amplifier

As the song goes, "Everyone is Doing It." For years the TV DX and FM weak signal worlds have plugged along with cascode and cascode circuitry, unaware the next step lower in noise figure might well be several years distant. Now the 417A booster-amplifier has appeared on the scene and its influence almost overnight is readily apparent. Experimenters from the East Coast to California, and north to the Arctic circle have written stacks of mail asking for *pre-printing details*, coil winding data, neutralizing details, and on and on. The reason for this enthusiasm is understandable. The truly great improvement in the *receiver noise figure*, through the simple addition of the 417A pre-amp, will in many cases be on a par with a fifty percent improvement of your DXing range on a *day to day basis!*

THE PRIME EVIL—NOISE

"Hear the noise in your speaker, see the snow on the screen, on a vacant channel?" Those dots, and that hiss, that's noise. Noise caused for the most part by the receiver itself. Noise caused almost exclusively in the front end of the receiver, or the tuner. *Noise . . . a barrier to weak signals.*

The way to bring border line, weak signal levels through the receiver made noise barrier? Lower that barrier, develop a circuit using a very high transconductance tube capable of "*amplification without adding measurably to the receiver noise.*" That tube, the 417A . . . that circuit, several variations presented here, and in the section to follow, in May.

THE 417A

Western Electric Company will tell you their tube type WE417A is manufactured solely for use by the Telephone Company, as a VHF amplifier. They will tell you this tube is not available generally, nor can they guarantee the tube's usefulness in circuits they themselves do not design. Lastly, they will not sell you a WE417A. Fortunately for progress some large wholesale houses are not nearly so short sighted. And fortunately for all concerned, the 417A can be purchased from Sweden, where the "Ericsson Company" manufactures the tube. In this country they are available at *State Labs, 649 Broadway, New York, New York.*

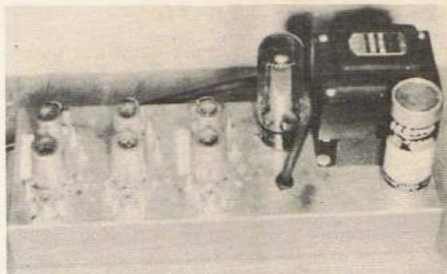

3 Channel 417A Pre-Amp by Hosken, North Bay

Other large wholesale houses such as Allied Radio can obtain the tube on special order. We recommend, however, you shop around through local VHF amateur radio operators. As a last resort, DXing Horizons has arranged through a California supply house to provide the WE417A in guaranteed good to excellent condition (they are all used, no matter where you obtain same, unless it is from Ericsson, or a large supply house. These "new tubes" cost considerably more, however with no increase noticeable in efficiency or life) for a paltry \$7.00 each (no shipping charges). Order through 417A, P. O. Box 3150, Modesto, Calif.

MECHANICS

The 417A is a 9 pin very high transconductance triode (20,000-25,000 micro-MHOS) capable of providing a front end noise figure of 2.0-3.0 DB on any VHF Channel 2-13, when *properly designed and adjusted.* Much may be said about the use of Ceramic or Teflon tube sockets. We can only say, let your conscience be your guide. You are using a \$15.00 tube, why put it in a fifteen cent socket? Mica, or wafer sockets have developed a great deal in recent years, but they still have inherent loss. Certainly the small extra cost of a ceramic nine pin miniature socket is not prohibitive. Teflon sockets are for the ultimate builder, who can afford such luxuries. They are to be recommended for the *lowest possible loss* when the builder wishes to spend the extra cash.

No attempt has been made to provide a chassis layout. The individual builder will undoubtedly have his own preferences.

A REAL SIMPLE STARTER

Parts wise, layout wise, and as far as the actual wiring time is involved, DXers throughout the world should be grateful to Jack Wright of Edmonds, Washington. The "Wright Circuit" is the picture of experimenter simplicity. Jack, through some obvious care and forethought, has come up with a 417A low

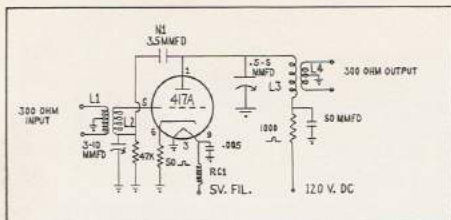

The Wright Circuit

noise circuit which even the novice can build and tinker with, changing the coils at will, attempting band switching (which we do not recommend) juggling voltages, and a hundred and one other innovations. And once the experimenter is satisfied with his 417A stage operation, he can use it as his front end amplifier, experimenting then with Ground Grid (GG) stages, as Stan Hosken of North Bay, Ontario describes in his "North Bay Ultra Amp."

Whatever the case, there should be no excuse, *even for the novice builder*, not to try his hand at the 417A "Wright Circuit."

THE WRIGHT CIRCUIT

Washington housed Wright constructed his 417A booster for Channel 8. Coils L1 and L4 are wound for 300 OHM input, and output (to match common feedlines and 300 OHM line, to the receiver, from the antenna). Channel changing (see coil table) will affect only coils L2 and L3. In the WRIGHT CIRCUIT, L1-L2 and L3-L4 combinations are identical, except turned around. The six turn clockwise wound coils (L2, L3) of course tune the grid circuit and plate circuit respectively with the help of the condensers C1 (3-10 MMFD) and C2 (.5-5 MMFD). RC1 in the Wright and RC1, RC2, in the Hosken circuit are radio frequency chokes in the filament leads. Hosken says 17 turns of No. 20 covered wire (insulated) on a one-quarter inch form make for good filament isolation. The only tricky adjustment, says Wright, is the neutralizing of the 417A. He uses a 3.5 MMFD condenser (gimmick) between the plate and one side of the grid circuit coil, as shown in the schematic. Once the unit is laid out and the wiring finished, Wright notes he runs only 5 volts AC on the heaters. The tube actually is built to run with 6.3 volts on the filament, but Wright notes it is an expensive tube and he personally would rather see it last a little longer . . . thus the 5 V. supply on the filament. Plate supply to the 417A should never exceed 120 volts under any circumstances. And every user of the tube recommends a plate millimeter, to insure the plate current does not exceed 20 MA.

With voltage to the unit, the antenna connected to L1, and a SHORT length of 300 OHM twin lead to L4, C1 and C2 are tuned for the best picture . . . using of course a weak signal to tune the amplifier. Once it is tuned, no further adjustment should be necessary. If it tends to oscillate (as indicated by black and white horizontal lines on the screen) back off on C1 and C2 to the point where you obtain best gain without oscillation.

Wright WRITES, "I built up this 417A booster pre-amp, and find it works very well. It is a decided improvement over the 6ES8, 6BS8, 6BQ7 and 6CY5 tubes I had in the shop to test it against."

NORTH BAY-HOSKEN ULTRA BOOSTER

Stan Hosken, creator of such electronic wonders as the 276 element bank of yagis (SEE FEBRUARY ISSUE, DXing HORIZONS) and the 30 foot parabolic dish for high band and UHF DXing, is also a whiz with a soldering iron and a low noise tube circuit. The Hosken circuit "shown" has carried the 417A booster one step further with a grounded grid 6AN4 stage following the 417A. This means a few more coils to be wound, but that is about all. Hosken's circuit is a true cascade, using the 417A, tuned grid, tuned plate, into the tuned cathode circuitry of the grounded grid 6AN4. Hosken uses 72 OHM input in his establishment, so coils L1, and L4 are only one and one-half turns on a quarter inch form. For 300 OHM inputs, the values Wright gives for 300 OHM in and out coils (1.5 turns clockwise, 1.5 counter clockwise, with the center tapped to ground) can be substituted. L1, L2, and L3, L4 are tightly wound one one-quarter inch diameter slug tuned coil forms, such as Millen 69048-B (No. 19 mixed core). L1 and L4 are reverse wound OVER L2 and L3 respectively, after L2 and L3 have been firm wound on their respective forms. Be sure to firmly fix all coils on forms with "Q Max" or a type of good airplane glue, for rigidity. Incidentally, much to dismay, we discovered the coil forms (Millen 69048-B) should be coded white powdered iron cores. The white coding denotes VHF use, and any other LF cores will add to the overall circuit noise figure (Horror!). L5 in the Hosken unit is also a one-quarter inch diameter powdered iron core slug tuned form, with the same number of turns as are found in coils L2 and L3. Of course it is wound alone on its form, while L2 is joined by antenna matching coil L1, and L3 is joined by receiver matching coil L4.

Hosken series tunes his grid and neutralizing controls with 4-40 MMFD miniature condensers. The input and output stages, and the plate tuning of the 417A are all fairly broad band in tuning with the slug tuned forms.

Again, maximum voltage must not exceed 120 volts, and the plate current on the 417A should be metered. Additionally, the power supply for either this unit or the WRIGHT CIRCUIT should be well filtered in both output, and on the primary side. Filtering of the primary side will be discussed in May.

Hosken has used 17 turn air wound coils (one-quarter inch forms) as RF chokes in the heater leads (pin 9, 417A, pin 3, 6AN4).

To tune the unit, find a weak signal (cut down a local signal by using a short length of twin lead, etc.) and tune the neutralizing condenser (4-40 MMFD off of pin 1, 417A) until all signs of oscillation go away. Then tune slug L2, peaking it at maximum signal. Repeat with slugs L5, and L3 in that order. Lastly touch up the series tuned 4-40 MMFD condenser on the bottom of L2 (grid circuit), and readjust the neutralizing control for maximum gain (up to the point of oscillation). Then, repeat the entire process of adjusting the slugs, peaking them up. And that is that!

SERVICE USE

It is recommended the booster be designed so it need not be used EXCEPT WHEN FISHING FOR

WEAK DX TYPE SIGNALS (or in the case of community or VHF booster stations, only when the signal level drops into deep fades). Using it all the time on weak as well as strong signals, will shorten the precious tube life of the 417A.

Lowering receiver noise figure from its present 5-7 DB, to the 2-3 DB region of the 417A pre-amp will give noticeable results similar to the transmitter raising its power four—8 eights, or increasing your antenna size to a phenomenal degree.

For absolute fringe area reception, if you can currently lock in a station 200 miles away, 75 PERCENT OF THE TIME, addition of this booster should increase that reliability to 95 percent of the time, at the same time increasing your "75% LOCK IN DISTANCE" to 250-275 miles. Fantastic? Build one . . . and see for yourself!

TV CHANNEL	L1 Turns	L2 Turns	L3 Turns	L4 Turns	L5 Turns
2	7.5	13	13	S	11
3-4	6.5	11	11	A	10
5-6	4.5	8	8	M L1	9
FM	4.0	7	7	E	8
7-8	3.0	4.0	4.0		3
9-10	3.0	3.5	3.5	A	3
11, 12, 13	2.5	3.0	3.0	S	2.5

All Coils use enameled wire, one one-quarter inch diameter slug tuned forms (Millen 69048-B, for VHF use . . . coded white). Channels 2-6 and FM band No. 28 wire throughout, while Channels 7-13 use No. 24 wire throughout.

417A Coil Winding Data

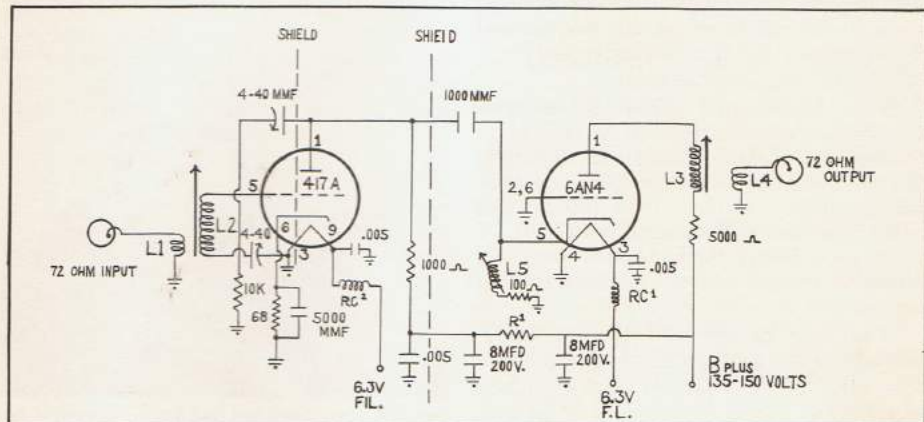

North Bay 417A-6AN4 Pre-Amp

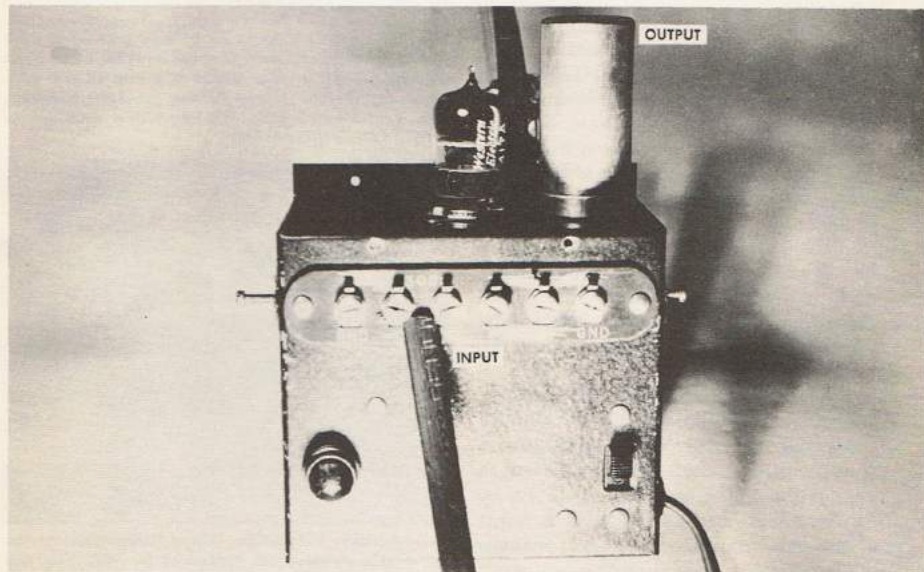

The Wright 417A Booster

Report From Geneva

Shortwave Broadcasting Frequency Management Plan

At press time, your SW Editor, KEN BOORD, received this up-to-the-minute, interesting report direct from ROGER LEGGE of the "Voice of America," United States Information Agency, Washington 25, D.C., on the high-frequency broadcast frequency management PLAN developed at the International Telecommunications Conference, recently concluded at Geneva, Switzerland:

"The International Telecommunications Conference, which concluded in Geneva in Switzerland, made no changes in allocations for the high-frequency broadcast or amateur bands, except that the 7.100-7.150 portions of the 7-mc band will become EXCLUSIVELY broadcast in Europe/Africa/Asia in May 1961, instead of being shared with amateurs in those areas.

"The major development affecting broadcasting was the adoption of a frequency management procedure for the high-frequency broadcasting bands. A summary of its provisions is as follows:

"1. Countries will submit their planned schedules for the high-frequency broadcasting bands to the International Frequency Registration Board (IFRB) four times a year, covering the following periods: March-April, May-August, September-October, and November-February. The schedule of each season will be submitted a specified number of months prior to the beginning of the season.

"2. The IFRB will prepare a composite broadcasting schedule, showing the planned usage on each frequency throughout the world. This tentative schedule will be published at least two months prior to the start of the season.

"3. Where conflicting planned usage of a frequency is noted, the IFRB will notify the countries involved and recommend changes in the schedules with a view to elimination of the conflicts.

"4. Schedule changes made as a result of the above procedure, and changes made on dates other than the beginning of each season, are to be reported to the

IFRB as soon as possible, and will be published in the IFRB weekly circular.

"5. The schedule for each season will go into effect on the first Sunday of the period. The first schedule will go into effect on September 4, covering the September-October period. The tentative schedule for this season will be published about July."

DX is truly indebted to Mr. Legge for this excellent "Report From Geneva."

—KEN BOORD



One of the best known and most highly successful of the rapidly-growing ranks of young USA SWBC DXers, ALAN ROTH, Connecticut, has just been named SWBC EDITOR for THE DX'er, house organ of the AUSTINTOWN (OHIO) SW CLUB, of which Paul Pormen, Jr., Youngstown, Ohio, is editor. This Club issues its Bulletin every-other-week during the year, and each issue has news for BOTH SWLs and AMATEURS. It also carries BCB and TV DX news. Please write direct to Mr. Pormen (at 5160 Mahoning Ave., Youngstown 9, Ohio, USA) for further details about ASWC. CONGRATS, ALAN!



Radio Australia's Transmitter Hall at Shepparton, Victoria. Incoming programs from Melbourne for VLA, VLB, and VLC transmitters are controlled by a technician at the master panel (left).

SHORTWAVE ANTENNAS

Part One

CARE AND FEEDING OF SHORTWAVE ANTENNAS

As old as shortwave radio is the adage "the receiver is only as good as the antenna system." And the saying has carried into modern day as well, frequenting the TV and FM DXing dens . . . *described by some as the modern day counterpart of the early day Gelena ticklers.*

As with Chinese proverbs, this phrase has not grown "old with age," but rather, today in 1960, following more than a half century of wireless, antennas are as important as they were in the beginning years. *Perhaps even more so, because today the construction and use of efficient SW listener antenna systems seems to have become a lost art . . . perhaps even forgotten.*

No self respecting SW listener in the 1930's (the first "decade of SW radio") was ever caught *with less wire in the air* than he could possibly afford. Virtually every shortwaver had not one antenna, but many, each instantly available at the throw of a switch. For the SW listener of the 30's knew that changing SW conditions, even during the period of a single 30 minute broadcast, could render one type of antenna useless, and make another "as hot as a pistol." So the enterprising SW man attempted to outwit old man ionosphere with a variety of antennas, each with particular receiving characteristics.

Then came World War Two, and following the war, double conversion Super Hets became as common as the SW listener. With the ready availability of the more sensitive receivers, went the desire on the part of the listener for antennas that compensated for the actions of the ionosphere and the changing SW conditions. In the 15 years since the re-birth of SW radio, *more and more emphasis has been placed on reliability of reception.* Hundreds of SW stations use thousands of frequencies, each selected after tens of hours of comprehensive study into the complicated science of SW radio propagation. All of this study, the use of multiple transmitters on multiple frequencies, is the SW station's desire to provide *you, the listener*, with grade A service as much of the time as possible. Witness the results . . . an estimated sixty percent of all shortwave listening, even by SWL's, is to transmissions *beamed at their section of the world.* Gone perhaps, is the desire to log stations while they are not in service to our particular section of the globe

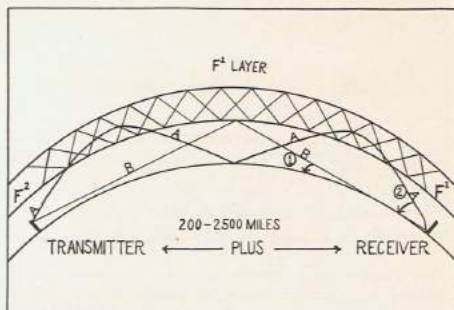

A signal often arrives at two (or more) angles. Signal A took two short bounces from transmitter to receiver while Signal B took one long bounce. Signal B arrives at a much lower angle. Signal A will fade out before Signal B, with reception remaining only on low angle antennas.

. . . or perhaps, gone is the ability to log them.

Let us renew this ability . . . or desire, in a manner reminiscent of the SW twirlers of the 30's (an era this writer does not profess to belong to).

IT TAKES A NUMBER OF ANTENNAS TO DO A NUMBER OF JOBS

Let's look at the whys of varying degrees of antenna effectiveness, and how antennas can be made to adapt to these conditions.

As seen in Diagram One, a SW signal can arrive at the receiver by at least two methods . . . and if space would permit, it would be a simple matter to demonstrate 20 more! All of which emphasize *the case for a versatile antenna system.* For with each variance in the ionosphere, the "angle" at which the received signal approaches the antenna, changes. Switching antennas, to take advantage of the new "angle of approach" can make as much difference as switching frequencies (which in affect is the station's allowance for the changing conditions, and "reception angle."). While a versatile antenna system can help the stronger SW services, it is intended that they be most helpful with the weaker services of the lower power stations not equipped to broadcast on several frequencies simultaneously. It is these stations that are considered rare DX, and they often go completely undetected by the SW fan equipped with a single antenna system limited to reception from only part of his radio "horizon" at only a few angles, or degrees.

VERSATILITY . . . IN TWO PARTS

Fading, and signal variation are encountered as two basic functions of antenna inadequacy. *Your antenna is "pointing the wrong way," and the station you are trying to hear is coming from a direction where your antenna gain is poor, or, your antenna has very little receiving*

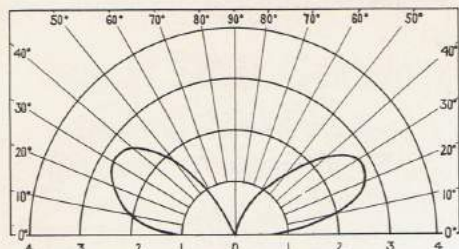

One-quarter wave length (at any frequency) above ground . . . pattern shows maximum antenna gain for signals returning at high radiation angles (20-40 degrees).

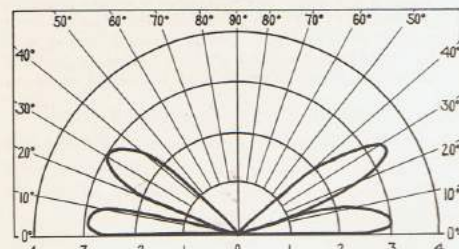

One full wave above ground . . . (at any frequency) the antenna now works best at the lower angles of radiation.

power at the "angle" the signal is approaching. Both can be remedied. To change the angle of "radiation" of the long wire, or dipole antenna, you merely raise or lower the antenna. Obviously this is not practical, so we install antenna twins . . . at different heights, and purposely set to give different reception characteristics. We thus double our chance for good reception, by being able to change angles of reception, with the changing ionosphere by changing antennas. This twin reception can of course be expanded to triple, ad infinitum, depending on the number of antennas you have the height and space to install.

Next the direction problem. At different heights above ground, etc., an end fed long wire antenna (or half wave dipole—with pattern modification) provides different "gain lobes" towards differing parts of the world. We may thus "partially" correct directivity problems with the same increase, or decrease in antenna height (through switchable antennas). But the real answer at any SW listening post should consist of four separate antennas, as in Diagram 3. These antennas, two sets of two, identical in size, at two heights, can compensate through switching, for changing "receiving angle" due to ionospheric variations, and, allow switching of antenna directions (i.e. from a north-south antenna to one favoring stations east and west of you, such as changing from antenna A-B, to antenna C-D).

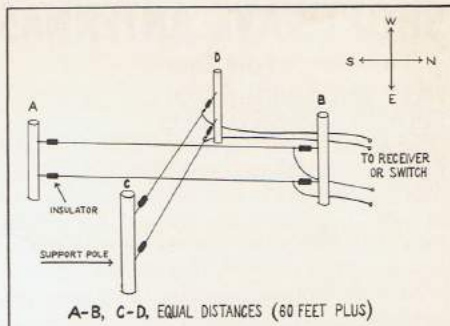

DXing Horizons' solution to antenna switching for changing ionospheric conditions (changing angle of reception of the received wave), and for simple pattern switching with north-south, east-west (any other combination) antennas. Antennas between Post A and B favor one direction, C and D 90-degree opposites. Antenna heights above ground (.25 feet, 60 feet) are merely suggestions.

You have the directivity problem cured, and you have angle of reception problem at least compensated for, to a large degree. This we call the *DXing Horizons basic antenna system*, and it may well be worth investigation, by you. Modifications, additions, and some improvements, as well as antennas for special cases, will follow in subsequent issues.

SW ANTENNA CARE . . . GUIDE BOX

- (1). If at all possible, avoid stringing SW antennas from TV masts and antennas. There is no surer way of guaranteeing squeals and squawks on your SW receiver from neighboring TV sets, than anchoring one end of the antenna to a TV mast!
- (2). Know your antenna's pattern! And then make sure that, if at all possible, the main lobe does not fall towards a local noise source, such as a main street (ignition from cars), high voltage lines (power line buzz), shopping center (neon signs, refrigeration units, etc). If your receiver is a continual buzz of noise, ignition, etc., it is a good sign your antenna should be restrung to favor another direction, probably with much lower pick-up from local noise sources. Nothing makes SW reception more difficult than an S9 noise level!
- (3). Continual antenna maintenance is a sign of too much insulator, or too little wire! Check the size of your antenna insulator. It "can be too big . . . and too heavy for the job." Carefully weigh wire size (in your mind) against insulator size, using the small egg insulators only for wire sizes No. 20 and higher.
- (4). Don't run antenna wires near TV guy wires. They may rub together in the wind, causing static discharge between the two, and noisy reception, in addition to the proximity to TV squawks and squeals.
- (5). Where possible, always use copper clad steel wire. The steel gives the antenna strength, while the copper coating assures you of good conductivity. Stranded wire stretches and sags. Steel core wire is less likely to sag.

More antenna tips next time "SW Antennas, Care and Feeding . . ." appears in *DXing Horizons*.
—R. B. C., Jr.

SHORTWAVE STATION REPORT

DXing HORIZONS SALUTES:
The World's Most Popular SW Station . . .

Radio Australia

When a SWL hears the call of "Jacko" (the Kookaburra or "Laughing Jackass") . . . or the plaintive strains of "Waltzing Matilda," played on a music box . . . or even the clock chimes sounding from the Melbourne Post Office . . . he knows immediately that "the world's most popular shortwave broadcaster" . . . Radio Australia . . . is on the air! Among the better-known voices from Radio Australia are those of Graham D. Hutchins, DX Editor, who presents "Australian DXers Calling" . . . and Keith Glover, who answers the mail in the "Mailbag" session—both are weekly features.

Radio Australia Programs—prepared in the Melbourne headquarters of the *Overseas Service* of the Australian Broadcasting Commission—are beamed around the world from powerful transmitters located at Shepparton, Victoria. Radio Australia has its own "official"



One of the world's most popular shortwave radio personalities, this is Graham D. Hutchins, DX Editor of Radio Australia, whose pleasant voice is well-known to thousands of SWLs in the far reaches of the earth. "Australian DXers Calling" is radiated to ECNA each SUN. at 1300 GMT on VLB11, 11.710, and to WCNA each Sun. at 1600 GMT on VLB11, 11.810.

RADIO AUSTRALIA SCHEDULES

Radio Australia broadcasts daily to ECNA at 1214-1315 GMT (news 1345) over VLB11, 11.710, and to WCNA at 1514-1615 (news 1515) over VLB11, 11.810; "Mailbag" is heard SUNDAYS at 1230 and 1530, respectively, in these transmissions. The WEEKLY DX session is scheduled SATURDAY 2200 to Japan, North Pacific Islands, 15.240; SUNDAY 0845 to the United Kingdom and Europe, 11.710; SUNDAY 1300 to ECNA, 11.710; SUNDAY 1300 to ECNA, 11.710; SUNDAY 1600 to WCNA, 11.810, and simultaneously to Asia, Europe, 11.740, 9.580, 7.220 (the 0845 transmission to the United Kingdom and Europe will MOVE to 0715 for the April-October period). Radio Australia's "winter" schedule will go into effect sometime in April—when the ONLY SCHEDULE ALTERATION will be in the time for the broadcast to the United Kingdom and Europe—at 0600-0730 (from present 0744-0859). The NEW Japanese Service to be effected in the "winter" schedule on a date to be advised, will be shown in Radio Australia's *Program Guide* for the April-October period. Incidentally, this attractive printed *Program Guide* is available FREE ON REQUEST from Radio Australia, Melbourne, Australia.—Ed.

monitors located in various parts of the world—among these are August Balbi of Los Angeles, California (WCNA), and Ken Boord, Morgantown, West Virginia (ECNA).

The popularity of Radio Australia is shown in many ways. It has been voted the most popular shortwave station in the world in two consecutive polls taken by the *International Shortwave Club of London*. Radio Australia receives more than 130,000 letters a year. These come from Iron Curtain lands (a few have been from Red China and Russia itself!), America, Asia, and from some of the world's most remote spots. Besides congratulating various departments, these letters ask scores of questions about Australian life. They range from types of animals and foods to domestic and business advice. Some questions have concerned the "correct age to start going out with girls!" Two recent letters from a Blind Institute in Java (Indonesia) were in braille. The letters show that Radio Australia is winning many friends and admirers for the Continent "Down Under."

(continued on page 29)

"The Mysterious E Skip"

"No mortal, no matter how wide his range of experiences, nor how vivid his past life, can fail to be startled, and perhaps even a little amazed, when what to his wonderous eyes does appear but a television signal, loud-strong and clear, from a station a thousand miles away. This is the strange E skip reception known almost entirely as a summertime phenomenon, capable of bringing DX reception to the smallest portable set and rabbit ears antenna, or to the deepest Rocky Mountain valley. E Skip . . . our subject as DXing Horizons looks at propagation . . . part two.

A summertime four month period of long range low band television reception in the 500-1500 mile range is upon us. This strange reception, caused by agents unknown, has long been the object of study by ionospheric scientists. We may not yet know what causes E Skip, but we do know this summer should be a good one for television reception in the 500 mile and up category! This DXing Horizons article should make you more familiar with a few facts we do know about E Skip, so you may make better use of it this E Skip season . . . '60.

Sporadic E Skip, the wonderful quirk of the rarified air above us, that sends low band television signals (Channels 2-6) bounding back to earth at some distant point 500 miles, or even 2500 miles, from the transmitter. Sporadic E Skip . . . often so consistent, frequent in occurrence, and strong in strength, that a DX station 1,000 miles away remains snowfree for hours or perhaps the better part of a whole day! Sporadic E Skip . . . at times not so consistent, nor nearly so strong. A drifting frame bar on a vacant channel, a sudden rise in receiver background noise, a carrier and a set of SYNC pulses rising above the noise level, coating the picture tube with a strange test pattern, or filling the speaker with the music of a Cuban summer baseball park. Sporadic E Skip . . . the wonderful agent responsible for endless hours of summertime DXing sport, and dozens of new stations in the DXers log. Sporadic E Skip . . . the myster-

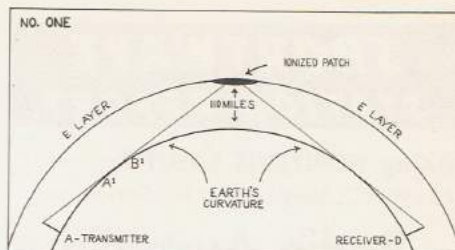

The transmitted signal leaves the transmitter (A) to travel along the Earth's surface (A1-B1), to rebound from the E layer (C) to return to the Earth at D, having traveled nearly 1,000 miles in the average "DX Hop."

ious, the strong, the wonderful, the thrilling . . . but most of all . . . the sporadic!

WHAT TYPE OF RECEPTION

Sporadic E Skip, sometimes referred to as E Skip, or Es, is aptly named, for the signal reception is truly sporadic. It occurs at random times, in greatly varying signal strengths, and at widely scattered points. Sporadic is an excellent tag for it indeed.

"E" . . . refers to that layer in the ionosphere, some 60-110 miles above the earth's surface. It is from this layer signals rebound, by a process known as refraction, or *the gradual bending of an electromagnetic wave in a medium of differing density*. Like the boomerang which "comes back," via a gradual sweeping-turning motion, the signal bounding back to earth from the "E" layer bends *within* the layer.

And finally, SKIP . . . as diagram Number One shows, the signal first leaves the transmitter at point A, traveling along the surface of the earth, gradually reaching a point where the curvature of the earth throws a shadow between the transmitter and the receiver. This is the fringe area (A1 to B1). And then the signal leaves the earth—off to the ionosphere.

Under normal conditions, *in the ionosphere*, the signal passes through the E layer, and through those below it, and above it, to move into space to be lost forever. But the E layer occasionally acts as a bender of signals (some researchers consider the bending to be a reflection, as a light ray rebounds from a silvered mirror.) The distinction here is of minor importance.) Bending our TV signal back to earth at point C, the signal lands again at some point much beyond the horizon, a considerable distance from the transmitter (distance A to D.)

It is then, the bouncing or refracting of the VHF signal (television or FM) from the E layer of the ionosphere that enables the signal

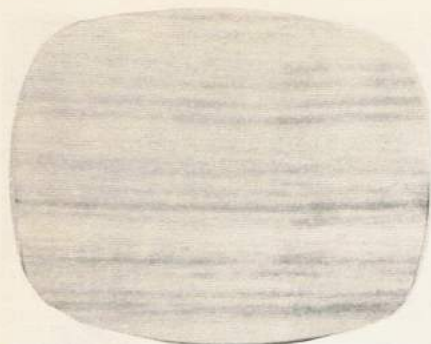

Horizontal bars on a vacant channel, or bars over a local of fringe station indicates interference from a second or third station . . . probably DX.



A good grade E skip signal from WGBH, Channel 2, Boston, as seen in Festus, Mo. by B. J. Bingham. Note the weak thin horizontal bars . . . more interference from a second Channel Two station.

to appear suddenly and with great strength at a distant point.

WHEN . . . AND HOW MUCH

The cause of the E layers strange reflective qualities is unknown. Not only do we not know why, but we are seldom able to predict when. We can only observe, and note that it is "more likely to occur" at certain times of the year, and at certain times of the day, than at other times. But it can, and has been known, to occur at every hour of the day and night, and on every day of the year.

Its strength (or how much) appears to depend on the quality of the reflecting layer . . . the E layer. Almost without exception, skip affects the lowest television channels first (Channels 2, or 3), and becoming stronger on these channels, stations in the same general area on the higher channels (4, 5 and 6) may be seen. Strong reception from stations on Channels 2-6 usually (but not always) indicates possible skip reception in the FM band (88-108 mc/s).

THE E LAYER

The E layer is one of the most unusual of the several bands of rarified gases existing above the troposphere (the layer of gases closest to the earth's surface). The E layer is generally believed to start at a height of 60 miles, and continue to a height of 120 miles. Its exact makeup is unknown, although many believe it is at least partially composed of sodium vapor, and sparse atoms of hydrogen gas. Whatever its exact makeup, *we know it is rarified*, and the number of atoms per cubic inch or foot few indeed.

It is generally believed some type of catalyst, when added to the E layer (either in the form of energy, or mass), causes it to ionize. The ionization process is one in which the atoms of the layer take on electrical properties. When ionized, the atoms become carriers of electricity, and the general electrical potential (or density) of the layer increases. It is this increase in electrical potential that gives the

(continued on page 32)

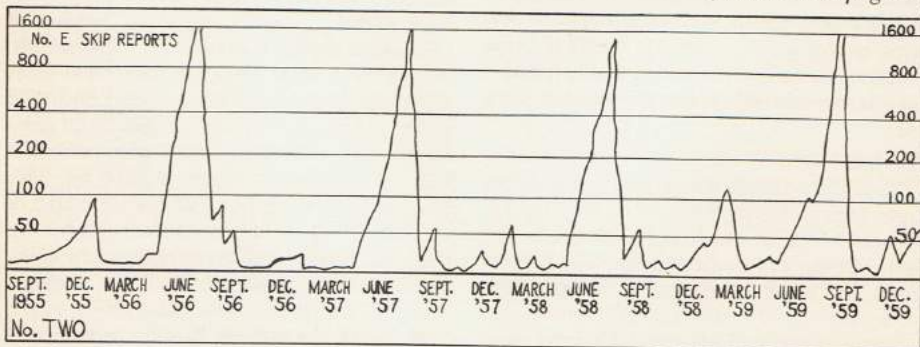

E skip loggings in USA-Canada — June '55 through December '59.

TECH NOTES

Swamped with "Projects"

The DXing Horizons technical staff is more enthused than usual as spring wears into the summertime E Skip season. The word *project* has taken on *extra stature* in recent weeks, as the work of getting out a magazine has become more like "fun" with word that a summer '60 planned E Skip research project, under the auspices of the magazine, may now become a reality. And the word project has taken on extra meaning as plans finalize for the DXing Horizons instigated "Project T3." But, one at a time.

PROJECT SCATTER

Publisher Cooper was an early fan of meteor scatter, and what it could do to bring at least marginal TV reception from stations 700-1200 miles distant for a few hours daily. Until recently, however, the right piece of land for such tests never presented itself, nor was there the right type of equipment available. Now both are readily available, and plans are going ahead with full steam. Briefly, the equipment consists of basic *40 element Channel Two array 110 feet above ground* (a box array of 4-10 element yagis). The output of the large array is to be fed through silver plated 300 OHM ladder line (open wire transmission line) to a series of *3 megacycle bandwidth pre-amplifiers*, using a 6922 tube in the front end, followed by the more conventional (but still not released) *6EJ7 high MU Pentode amplifier*. The location has been picked for its "lack of noise." The final signal will feed a 4 IF receiver, which is scheduled for an early review in these pages. *The purpose of all of this sheer gain? To see how much residual signal is being propagated via the ionospheric forward scatter mode.* A special report is being prepared for early presentation on the detailed gear being assembled for the summer long tests.

PROJECT T3

More fantastic are details that group of Air Force meteorologists stationed on Ice Floe T3, 650 miles NE of Anchorage, Alaska in the Arctic Ocean (74 degrees north, 130 degrees west), will be set up to receive TV signals this spring, through the efforts of DXing Horizons and several very enthusiastic and helpful manufacturers of TV DX equipment. Ice Floe T3

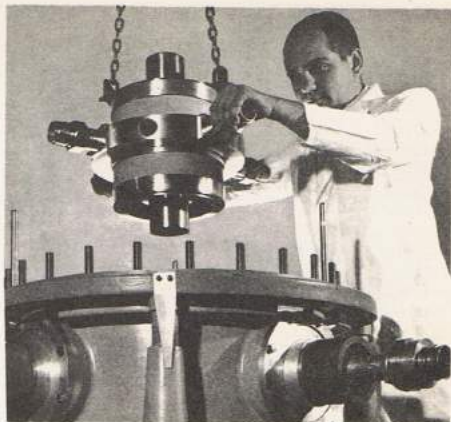

RCA technician Gerald Grill lowers the world's most powerful tube into a test chamber at the RCA ELECTRON TUBE PLANT in Lancaster, Pa. This 150 pound monster tube is capable of 5,000,000 watts peak power (long pulse) on frequencies to 450 megacycles. Its importance may soon be demonstrated when it is put to use in super high power scatter circuits which are destined to be the forerunner to intercontinental TV. (Photo courtesy of RCA Electronic Age)

is, *by now*, an ice island 150 feet thick and approximately 5 miles wide and 10 miles long. Stationed on T3, a dozen USA scientists have gathered with quonset huts and nearly one million dollars in equipment to observe the facets of Arctic life, weather, and communications. And throughout the spring and through much of the summer, New England bred Robert Mellen on T3 to study weather, will also be keeping an eye on Channels 2-6 with donated equipment arranged from leading USA manufacturers by DXing Horizons. All of this is not without some forethought. You see, last year, in the late summer of 1959, *Mellen and others observed, on a communications receiver, while stationed on T3, north of Alaska proper, almost nightly reception of video carriers of USA, Alaskan, and Canadian TV signals.* This, though the nearest Alaska station is 650 miles south, the nearest Canadian station 1,500 miles south, and the nearest USA station 2,100 miles south! And reception peaked after midnight EST, as the stations began signing off. This year, properly equipped with the right kind of sensitive TV gear, DXer Mellen and his cohorts are prepared to contribute reams of information on a brand new type of DX reception (we call it *trans auroral scatter*) to the VHF world, through regular reports to be carried exclusively in DXing Horizons!

International DXing Horizons



REPORT FROM SURINAM

In the 7 years this writer has been corresponding with TV DX enthusiasts in far flung spots on the globe, I have often received reports of extraordinary interest, only never to hear from the correspondent again. Perhaps the DX fan lost his interest, perhaps he lost contact with his medium of communication (at that time, the TV DX COLUMN in RADIO-ELECTRONICS magazine). The following report, from OTTO MORROY, of PARAMARIBO, SURINAM, is one such "piece of extreme interest."

Surinam is on the northern coast of South America, in the Guianas group (formerly known as Dutch Guiana). Morroy, amateur radio operator PZ1AC first became interested in TV DX when he rebuilt his Hammarlund Super Pro receiver to tune as high as 42 megacycles (SP400 apparently). In so doing he found BBC-TV, London audio receivable (5,100 miles) almost daily in the fall of 1958 on 41.50 megs. Wondering what he might hear from the nearest TV stations (Caracas, 940 miles to his west), Morroy built a converter for Channel 2, and the very first evening, October, 1958, logged audio for nearly one hour from the 59.75 mc/s Caracas Channel 2 outlet.

PHILIPS

As luck would have it, a trade fair from the mother country (Holland) some months later shipped two Philips TV receivers (western hemisphere standards) to Paramaribo for demonstration purposes. Following the fair, Morroy persuaded the Philips' Agency to loan him one set, which he connected to a large rhombic antenna (cut for 18 megacycles) at the commercial receiving station where he works, outside Paramaribo, on the Atlantic seacoast. The Philips set was in use at the radio receiving station (equipped for ionospheric measurements, etc., including overseas reception from Holland on the SW bands) March 1-31, 1959. Reception was almost daily from Channel 2, Caracas (YVKS, 62 kW.) between 1300 and 2000 LST (1.5 hours ahead of EST), with occasional reception from YVLV (15 kW, Channel 4). The receiver was shipped back to Holland after March 31, but on April 2, Morroy received a rush shipment "vintage model" 12 inch RCA receiver (model KCS45) from an acquaintance in the USA. With the receiver, came a JFD Star Helix Antenna.

Through May, June and July, 1959, Morroy continued to log the Venezuela stations on Channels 2 and sometimes 4, with reception on Channel 4 much shorter lived than on 2 (never on 5). Reception was poorer in May than March (not active in April), and in mid May reception spread to include WKAQ (2, San Juan, Puerto Rico, 1,250 miles). On May 23, 1959, Morroy logged WAPA (4) San Juan, HIT, Channel 2, Dominican Republic, the rare low power relay station, WKAQ, and of all surprises, signals on Channel 6 and 7 (unidentified)!

In June reception continued from Puerto Rico and Venezuela, with WORA (5, Puerto Rico) June 26, and a Channel 6 station believed to be in

Central America logged with a mystery Channel 3 station, at 3 P.M. on June 26. Most June reception, like previous months, concentrated between 1430 LST (1.5 hours ahead of EST) and 1900 LST, although Caracas stayed in until 2400 LST on June 28, after appearing on the screen as late as 2200. During July, Puerto Rico and Venezuelan reception continued, with reception time shifting from 1130 LST to 1500 LST most days.

AURORAL-ES

Space is limited this month, but we would like to instigate a plea for reception reports from Canadian (and N. USA) DXers (especially in Saskatchewan, Alberta, Manitoba) which seem to fall into similar categories with the reports which follow. For several years it has been the contention of this writer that August-September and March, auroral sessions are capable of supporting seemingly single hop (although not Es distance) east-west skip on Channels 2-6 over distances varying from 700-2700 miles. The reception usually occurs after 2300 EST, following a tumultuous aurora session. The E skip appears (we call it E skip here only for lack of a more definite term) on the receding edges of strong aurora sessions, which have stretched (visibly) into the mid west and northern "Mason-Dixon Line" states. Such aurora sessions often die down between 2300 and 0030 EST, springing into life again after this recession. Now the reports.

AUGUST 16, 1959, 2030 EST to 2130 EST, CFRN, 3, Edmonton, Alberta, logged by Ron Boyd, Truro, Nova Scotia, 2350 miles, garbled video.

MARCH 21, 1959, 1935 EST to 2110 EST, William Fishley, Nitchequon, Quebec, logged CKCK-TV, 2, Regina, Sask., 1475 miles, garbled video.

SEPTEMBER 4, 1958, 2300 EST to 2307 EST, CKX, 5, Brandon, Manitoba, logged by Ross Harvey, Goose Bay, Labrador, 1825 miles, garbled video.

CENTRAL AMERICAN INFORMATION SOUGHT

Franklin G. Brown, Easley, S.C., writes he has logged a CMBF Cuban network on Channel 2, in addition to the CMAB (Habana), and CMKU (Santiago de Cuba), stations listed in the February Central American listings. Brown has also logged a CMQ station on Channel 3. Can anyone help with these station locations (how about some of our Florida and Cuban readers?).

Incidentally several mid-western DXers report the call XEFB, Monterrey, Mexico, on Channel 3. We have XHNL in Monterrey on 3 (old 2). This we accept, and XHNL has apparently moved to Channel 10, also Monterrey. A new "mystery Channel 2" is on in either San Luis Potosi, or Tampico, notes DXer Dave Beal, Arizona. And the Channel 6 relay reported as likely in Acapulco, remains there, with still no "OFFICIAL" word from XEW. DXer Beal adds it carries XHTV programs as well as XEW. Again, any and all information appreciated.

TV Reporting

The late February—early March reporting period is not known for its excellent DX, in any form, on the TV bands. It is perhaps a good opportunity to take further stock of some of the achievements of our reporters, in the past, and as space permits, delve further into the extraordinary DX session of late January—early February in the Great Lakes-Midwest region.

TV DXer Bill Pagel of Glen Ellyn, Illinois brings us up to date with his DXing activities which culminated most recently in his observance of excellent UHF ground-wave as late as February 6, and 12. On February 6 Pagel logged 15 UHF stations stretching from Madison, Wisconsin (WMTV-33) south to down state Illinois and east into Indiana. The February 6 UHF reception over distances to 250 miles appears to have escaped other Illinois DXers. Pagel first noted fringe reception on UHF improving at 1700 EST, and stayed with it until 2330 EST. These were Pagel's first UHF loggings, having only days before added UHF equipment. His station total stands at 77 seen.

DXer Ed Prond, Dolton, Illinois, is another enthusiast who caught the session of January 30-31, and February 1-2. Prond's best of the session was KHQA-7, Hannibal, Mo., 335 miles, logged 0800 January 31. Prond's DX total rests at 129 stations seen.

Walter Owen, Jr., Springfield, Ohio, also found VHF signals popping their fringe areas the afternoon of the 31st, and again on the afternoon of February 2. WSIX-8, Nashville, Tenn. was seen over a 276 mile distance on the 31st, while WHBQ, 13,421 miles was logged with good signals on Feb. 2. The Owen's DX total now stands at 142 seen.

Sidney L. Emmons, Galion, Ohio complains of the high occupancy of the VHF band in his area, noting he sticks to the UHF when ground-wave gets hot. Emmons sat at the very eastern edge of the excellent ground-wave session discussed at length last month. As the fog rolled over his southern Ohio location he first noted "UHF poppin'" at 2100 EST on January 30. The best hauls that evening were WEEK-43, WMBD-31, and WTVH-19, all 350 miles distant in Peoria, Illinois. The good UHF, and better than average VHF reception, lasted all day of the 31st and Emmons notes VHF channels were jammed by co-channel interference by noon of the 31st. 16 UHF stations were logged on the 31st, 100 miles distance, and further! Topper for the session, WICS-20, 375 miles, Springfield, Illinois, seen from 2300-2330 EST on the 31st. Emmons uses a 55 model GE receiver with built-in UHF converter, and a Jerrold UHF antenna above his 7 element Channel Master Traveling Wave VHF array.

DX IN THE SOUTHLAND

True to form the month of February did not produce any spectacular DX even south of the Mason-Dixon line where such DX is more likely to occur. Strangely missing this year are springtime reports of reception from Mexico City low band TV channels during the winter months. What has happened to DXers in New Mexico, Arizona and Texas, during this usually favorable period for Mexico City reception on Channels 2, 4, and 5?

There was a smattering of tropo (ground-wave) reception in the south at varying times. DXer Donald Ruland reports WJBF, 6, Augusta, Georgia on February 3 from 0650-015, at 300 miles, and on the 26th of February, a narrow band of tropospheric between Ruland's Holly Hill, Florida location and Wilmington, N.C. brought in WEST-6, at 425 miles. Ruland's totals are 139 VHF stations received, 122 verified. Ruland also did well with meteor burst DX during February, logging numerous northern Channel 2, 3 and 4 stations (KMOX-4, St. Louis, WLWD-2, Dayton, KYW-3, Cleveland, etc.), most mornings, between 0600 EST and 0900 EST.

Franklin G. Brown, Easley, S.C. also went to work on meteor bursting DX during the 0700-0900 EST hours of February, logging such as KFO-2, St. Joe, Mo., WKY-4, Oklahoma City, and WWL-4, New Orleans. On February 29, tropospheric stretched to WSFA-12, Montgomery, Alabama, and WTOC-11, Savannah, Georgia, in the 200-300 mile range.

In the Great Lakes region Frank Wheeler found ground-wave the only productive form of DX, and only a smattering at that. Wheeler used his Erie, Pa. location to spot WJIM-6, Lansing, Michigan, 236 miles, February 13, while he found February 21 a good day when WSPD (13-185 miles) and CKLW (9-Windsor) were both viewable.

From Gunnar, Saskatchewan, far north near the Yukon Territory, DX enthusiast Dean Charles writes as follows, "Using a pair of rabbit ears on the only set in this uranium mining camp isolated from civilization, I found CHCT-2, Calgary, and CFCJ-TV, Port Arthur, pounding through on two different nights in early March. Distances are 600 miles and 1,000 miles respectively. As we have no radio, movies, and our only link with the outside is by plane three days a week, I decided to see what TV DX could do for entertainment. After good results with just the rabbit ears, I have installed a set of stacked ten element Channel 3 yagis, and a three tube cascode booster built by Benco. Now things should really start popping!"

DX regular Jim Himes, Joes, Colorado, continues to spot DX. Himes attributes a lot of his DXing prowess to his high and clear stacked all-channel Trio 88 antenna 55 feet up, and a "Jerrold De Snower Booster," designed for sensitive cable system application. Via meteor bursts, Himes caught identifications from eastern stations February 17, 20, 27 and March 4, 5, 8 and 10. February 27 was the best day as Chicago (WBBM-2), Dallas (KRLD-4), San Antonio (WOAI-4), Cedar Rapids (WMT-2), Paducah, Ky. (WPSD-6), and Huntington, W. Va. (WSAZ-3) were logged between 0743 and 0855 EST. Not bad for a day when the band wasn't open for DX!

TOTALS REPORTED

Mike Handley wonders about the sensitivity of the new color receivers. Handley's station total of 50 stations was run up on an older model black and white counterpart. Handley DXes from Norfolk, Virginia.

David Kanaar has recently moved to Buffalo, New York, from Saskatchewan, Canada, and finds the rigors of fighting overpowering locals rewarding when DX conditions are good. Arriving in Buffalo virtually too late for the summer '59 skip season, most of his totals have been accumulated on ground-wave with his best haul to date WOOD-

8, Grand Rapids, Michigan, 360 miles. Kanaar DXes with a 59 Zenith receiver, and various Yagis and UHF Bow Ties at 60 feet in the air.

Bruce Blake of Phoenix is another DXer using a Zenith model receiver. Blake's DXing shows a smattering of E Skip reception from stations throughout the west and midwest during June and August of '59.

DX DOWN UNDER

TV is brand new to New Zealand, and Bob Morse is one of the first to try a hand at DXing in that country. Morse notes he has picked up three Australian stations, including ABS in Adelaide, 2500 miles, on Aussie Channel 2. Morse promises a full report in the IDX section for May.

DXer George Palmer, well known Australian and the current world's TV DX record holder (10,800 miles), sends along a most interesting report of Australian E Skip during January 7 and February 1 E Skip sessions. Palmer logged Channel 2, Brisbane, some 1,000 miles on January 7 and sends along some excellent photos of the "ABQ" call slide. On February 7, Palmer logged "ABS" in Adelaide, South Australia, a short E Skip distance of 450 miles. E Skip seasons south of the equator peak during our "northern hemisphere" winter.

PROPAGATION CALENDAR

APRIL 1-15—Very slight chance for E Skip 1600 LST (4 P.M. Local Standard Time) to 2000 LST.

Southern USA-Gulf Coast — Excellent chance for extended ground-wave DX over the Gulf, and through the south. Watch high band channels first for signs of strengthening fringe signals.

APRIL 16-24—Fair chance of E Skip, 1600-2000 LST.

Generally improving ground-wave during evenings in all areas of USA.

Excellent meteor shower, April 21. Lyrids shower should produce increased burst count from April 19-22, peaking on the late afternoon of the 21st. Low and high VHF channels.

APRIL 24-30—Good chance for E Skip, 1500-2100 LST. Fair chance for E Skip, 0700-1000 LST.

MAY 1-15—E Skip season, any time, any direction, any low band (2-6) channel. Reception from 500 to 1500 miles.

MAY 6—Aquarids meteor shower, excellent rating. Peaking shortly after noon LST, leveling out through 1700 LST, has been known to appear as weak E Skip, because of its strength and duration.

MAY PREVIEWS

This will be our first SPECIAL ISSUE. May is dedicated to weak signal systems, with a special report on the new EITEL UHF-TR-10 Translator, an article written by Frank Nowaczek, Jr., Public Relations Manager for the NCTA, concerning TV cable systems in the USA, and a special report on VHF Booster-Translators. This will all be exclusive and extra, to the normal fact filled features, departments, and sections.

AIPA Leads the Way!



The AIPA Convention held in Ohio in 1957.

Readers of the January issue of DXing Horizons will recall our "DXer of the Month," weak signal TV enthusiast Art Collins of Buffalo, New York. In addition to his fine work as an individual DXer, Collins is the president of the world's only "Television DX ONLY Club," the American Ionospheric Propagation Association.

The AIPA was born in November of 1953 when an "ex New York State DXer" . . . a fellow by the name of Cooper, moved to California and lost contact with a dozen or so TV DXers he knew along the Eastern Seaboard. Consequently a ditto machine was pressed into service to keep in contact with the DX enthusiasts in the east. The ditto machine turned out the first "AIPA" bulletin in the fall of '53, 100 copies strong, mailed to 40 active DXers of the time. Soon reports were pouring in, for this was to be a monthly letter (soon a bulletin) with reports from active DXers, and even an occasional feature or two, such as an early article concerning the use of rhombic antennas for fringe area reception. Today the earliest AIPA bulletins are scarce indeed, even considered collector's items. But not so with the modern AIPA bulletins. To be sure, the bulletins of today are still collector's items, for the information within their pages is still considered to be of utmost interest by DXing enthusiasts throughout the world. But they are no longer scarce, for the work of the AIPA production staff has grown with the years, so until today it is considered a very complete bulletin, and well circulated within its field.

Some of the world's top TV DX enthusiasts are AIPA members, and president Art Collins is always happy to entertain applications from non-member DXers desirous in obtaining the AIPA Bulletin (currently \$3.00 per year). A letter from interested TV DX fans to Collins at 68 Amber Street, Buffalo 20, New York should bring complete details.



TV DXers ALL . . .

Back row: King Schafer (N.Y.), Don Voegelé (N.Y.), Art Collins (N.Y.), B. J. Bingham (Mo.), Bill Eckberg (Ill.), Tom Hidley (Ill.) and Bill Nieman (N.Y.).

Front row: John Broomall (Ga.), Walter Spaulding (Ohio), John Voegelé (N.Y.), Bob Seybold (N.Y.), Ed Prond (Ill.) and H. E. Apley (Ohio).



WEAK SIGNAL INDUSTRY

Legislation Pending on Cabled TV Systems

As we write early in March the United States Senate is bitterly embroiled in a Civil Rights debate, the outcome of which will have no bearing on this topic, save the time it takes for the senate to resolve that outcome. For in the Senate hopper, right behind the Civil Rights measure, is Senate Bill S.2653, designed to regulate and control community TV antenna systems in the USA. The bill, if passed with only minor amendments, would bring the operation of community cabled TV systems under the direct control of the federal communications commission, and allow the FCC to enforce such points as follows, if they so chose:

- (1). *Require cabled systems to carry the programming of the local or semi-local stations, as well as that of the more distant "big city" outlets.*
- (2). *Place tighter control on the use of microwave relays for the purpose of carrying grade A television service to a distant town, for cable distribution.*
- (3). *Possibly outlaw cabled systems in areas where all three networks are available to viewers with off the air pickup (direct home reception).*

This last point is a mute one however, and considered to be possible only by the most radical opponents of Community Cabled TV (CATV).

There are an estimated 2.2 million homes in the USA that receive their television from cabled TV systems. Community TV antenna systems range from the smallest (serving a few dozen sets on a joint ownership basis) to the largest (some serving 10,000 plus receivers). Systems (nearly 700 large ones) provide service ranging from one snowy channel equal to fair fringe area reception, complete with god and bad nights, to systems distributing 7 channels, plus such "extra services" as 24 hour background music, and perhaps "local live television fare," on the cabled system, featuring local personalities, in news shows, etc. from a local studio.

PICK 'N CHOOSE

At the present time, with no authority regulating the operation of community television systems, system management is free to pick and choose the viewing fare it wishes to peddle to the local cable subscribers. In some cases this has involved a purposeful "non use" of the local television signal, which means *not carrying* it on the cabled system. This, "the local station" will tell you, is an unfair practice rendering them incapable of competing with the multiple station viewing fare available to cable subscribers. Isolated towns, such as Pocatello, Idaho, are normally served with only one station. Pocatello's only real market area is within the city itself, with only a pitance number of viewers scattered about the remaining countryside. But a cabled system, operated by Bannock TV, Incorporated, distributes Salt Lake City grade A signals (KUTV, KCPX, KSL) to the Pocatello subscribers.

CABLE SYSTEM MOUNTAIN TOP ARRAY

Bannock has their antennas (multi stacked yagis in a weatherproof building) on a 7,000 foot mountain, and their Salt Lake City signals are grade A all the way. No fading, snow, or interference. Had cable vision not found such good SLC signals close to town, they might have done what other systems have done . . . install microwave relays from a point much nearer the transmitting station, bringing TV to the town to be served.

Such a microwave link is being installed across the mountainous regions between Seattle and Wenatchee, Washington. Wenatchee currently is fringe area viewing for Spokane stations on Channels 2, 4 and 6. But the *Consolidated Television Cable Corporation* of Wenatchee has dubbed a project to bring Seattle stations to the inland valley "big switch." According to *Consolidated Cable*, the new system will deliver Seattle stations to the valley area for cable distribution, at no appreciable loss, meaning receivers will mushroom (they hope). Of course the question asked by Spokane stations, "Why don't you distribute our signals to Wenatchee, we are a good deal

closer" receives the stock cable company answer, "Seattle is the big city, with big city viewing fare . . . we have a product to sell . . . entertainment, so we have chosen the Seattle product because it offers more.

COMPLAINTS AND TROUBLE

Obviously such cable system policies, as found in Wenatchee, or Pocatello, are only two examples amongst the many, and such attitudes are bound to stir the wrath of *somebody—somewhere*. It has stirred the pot of TV broadcasters, most of whom insist they do not want their signals plucked from the ether and sold along the street by picture merchants. TV stations fighting CATV systems maintain that broadcasting is free, for the public. To this the CATV operators answer, "We agree, the service is free, and so are our programs, we are merely renting the viewer the use of our antenna to receive these *free broadcasts*." As well, CATV has invoked the wrath of western legislators who maintain that "even if CATV is legal, it should be controlled by the FCC," with regulations pointing towards fair and equal service for the local station in the town being served by the community antenna group. At least one telecaster (KSPR, Channel 6, Casper, Wyoming) has left the air because of alleged CATV competition. KSPR left the air in the late summer of 1959, after stating they could not compete with the microwave system bringing Denver signals to Casper, nor with the fact that Casper's second TV station (KTWO, 2) was being carried on the cable, and they (KSPR), were not. KSPR claimed inability to compete with the economics of the situation, and threw in the sponge.

SOME STATIONS LIKE CATV

On the opposite side of the fence, at least one commercial TV station (WDAU-TV, Channel 22, Scranton, Pa.) has given the CATV service a pat on the back, commending it for greatly increasing the WDAU coverage area. WDAU claims it reaches an additional 90,000 TV homes through the efforts of area CATV systems.

NOT AN EASY QUESTION TO DECIDE

The FCC fully recognizes the CATV problem, like the VHF booster-repeater problem, will not be an easy one to decide. CATV is too firmly imbedded in the American countryside, with a history dating back more than a decade in the mountains of Pennsylvania, where it was born. It is not a broadcasting service, it is a reception service. Something the FCC has

little power to control at the present time. The FCC is in a position to control the microwave licensing of CATV systems, where the more elaborate systems bring distant town signals to isolated towns, via single or multiple top microwave, however.

PERHAPS THE ANSWER LIES TO THE NORTH

Once again Canada's Department of Transport (DOT) acting under the supervision of the Broadcast Board of Governors, has set a precedent by acting to control at least in part the activities of CATV systems in that country. And to date, the control system seems to be a fair and just solution, with no complaints heard from any quarter. Briefly, this is what the DOT has announced (in a September, 1959 release):

(1). *The licensee of a broadcasting receiving community antenna system is required to carry Canadian programs where the reception of such programs is technically possible.*

(2). *Where the area involved is not served directly by an existing Canadian television station, and where the area involved (that area to be served by the proposed CATV system) is in all likelihood too small to support a television station, and is not likely to assume such proportions within the foreseeable future as to be capable of supporting a television station, the DOT may give consideration to the application for a system to be served by microwave relay from a distant station(s).*

(3). *The license authorizing the construction and use of a radio (microwave) relay would become null and void at such time a station is established for television broadcasting in the area served by the CATV system.*

(4). *The DOT does not intend to license CATV operations in towns where existing television service is available.*

This is the meat of the Canadian regulations, which are simple, straight forward, and direct. Such action, if adopted by our congress, as "in part" incorporated in Senate bill S.2653, might mean drastic changes in the multi-million dollar CATV industry in this country. And *quite possibly*, greatly reduced viewing fare for a million plus viewers in the USA.

The preceding material is by no means intended as an editorial. DXing Horizons does not, at this time, wish to take a public stand relative to the merits of CATV regulation by the FCC.

BRING THIS SIGNAL

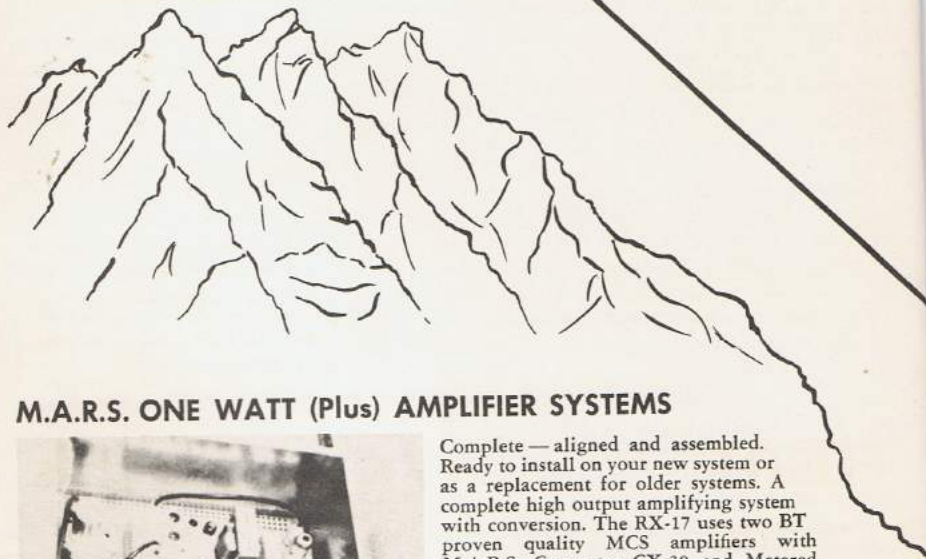

M.A.R.S. ONE WATT (Plus) AMPLIFIER SYSTEMS

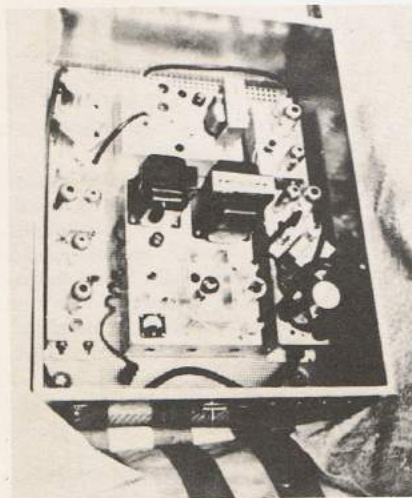

Complete — aligned and assembled. Ready to install on your new system or as a replacement for older systems. A complete high output amplifying system with conversion. The RX-17 uses two BT proven quality MCS amplifiers with M.A.R.S. Converter CX-30 and Metered Final (F-17).

The system is capable of one watt PLUS output with as little as 50 microvolts input.

The unusual range of automatic gain control enables complete pre-adjustment to accommodate ANY useable signal level.

Metered output eliminates guesswork for fast — efficient operation.

AVERAGE VALUE SPECIFICATIONS:

Gain: 110-120 DB.

Conversion Accuracy: .005%

AGC: 40 DB.

Input Range: 50 Microvolts to 5000 Microvolts

Output: One Watt Plus

Power: 115 Volts AC 60 Cycle (140 Watts)

Cables: Low loss input and output cables and baluns to match 300 OHM line are included.

Installation: Can be done by anyone in a short day.

Price: \$957.00

M.A.R.S. CRYSTAL CONTROLLED CONVERTER CX-30



RELIABILITY . . .
The world's most reliable converter-amplifier units, with 10,000 hours tube life in premium quality Amperex 6922 Tubes. The CX-30 is the heart of any amplifier system

which requires the highest accuracy in conversion, and maximum reliability. Input may vary from 1,000 Mu to 100,000 Mu at 75 OHMS. One-half of the second 6922 is reserved for possible use with a coding on-off system.

AVERAGE VALUE SPECIFICATIONS:

Gain: 15 DB on Low Channels
10 DB on High Channels
Conversion Accuracy: .005%
Power: 115 VAC, 60 Cycle — 17 Watts
Input: 1000 to 100,000 Mu at 75 OHM.
Tubes: Premium Quality Amperex 10,000 Hour 6922's.
Price: \$195.00

M.A.R.S. ONE WATT FINAL TV AMP. F-17

Mountain top locations require the very best in equipment . . . and when you need 10,000 hour reliability, high output, and broadcast quality amplification . . . M.A.R.S. equipment is for you. Maintenance calls are held at the lowest rate in the industry with M.A.R.S. equipment . . . and the F-17 amplifier.

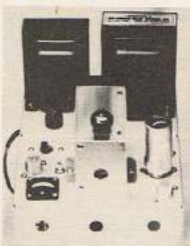

AVERAGE VALUE SPECIFICATIONS:

Gain: 26 DB over Each Input
Band Width: 6 MC (Plus-Minus) One DB.
Power Requirements: 115 VAC, 60 Cycles, 70 Watts.

Output: One Watt Plus

9 Volts at 75 OHM
18 Volts at 300 OHM (Through Balun)
.80 DB above One Millivolt.

Meter: Switch and Meter to Monitor Plate Voltage and Relative RF Voltage.

Tubes: Premium quality Amperex 6922's and 6360's (10,000 Hour Rating)
Price: \$395.00

IF AND WHEN VHF BOOSTERS BECOME LICENSED, THIS F-17 UNIT WILL PROVIDE A QUALITY PICTURE UP TO 40 MILES.

The following chart shows channel conversions available. The shaded areas should be avoided if possible.

HERE

with

M.A.R.S. Amplifier Systems

C H A N N E L S

	7	8	9	10	11	12	13
2	126	132	138	144	150	156	
3	114				138	144	150
4	108	114	120	126			
5	98	104	110	116	122	128	134
6	92 Trap	98	104	110	116	122	128



"Vallytown
USA"



MID AMERICA RELAY SYSTEMS, INC.
601 Main Street
Rapid City, South Dakota

THE WORLD

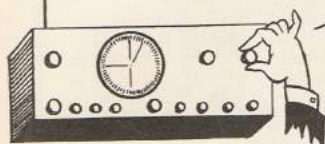

AT A TWIRL

Edited by DXing Horizons Shortwave Editor
Ken Boord
948 Stewartstown Road
Morgantown, West Virginia, U.S.A.

With PATIENCE and PRACTICE . . . under ordinary conditions . . . it's no trick at all to log all continents on the SW bands in a single evening . . . *at times even within a few minutes!*

And all you need is a shortwave receiver . . . a simple receiving antenna . . . a knowledge of "where" and "when" to listen . . . PLUS PERSISTENCE!

In fact, any type of radio receiver which will tune to the shortwave bands will do as a "starter." It may be an all-wave broadcast receiver . . . a home-built shortwave set . . . or a low-priced communications-type receiver. In any case, my advice . . . from my own long experience and that of other veteran SWBC DXers . . . is to get THE BEST EQUIPMENT WHICH YOU CAN AFFORD.

As to the antenna, *your location and the space available may "make the difference"* so a good "clue" is to EXPERIMENT A LITTLE.

An outside wire . . . *as high as possible . . . and clear of all obstructions . . . IS ESSENTIAL.* For best, over-all reception, *most experienced SWLs seem to prefer the ordinary straight wire . . . often referred to as the Marconi or the "inverted L."* A length of 30 to 100 feet should give you excellent results *on most SW bands.*

Shortwave transmitters include land communications stations, maritime stations, aeronautical stations, amateur (*ham*) stations, broadcasting stations and, of course, more recently, stations aboard *satellites* rocket-thrusted into outer space! Of these, the *broadcasting and amateur* stations are of most interest to the *average SWL.*

By international agreement, each type of station is assigned certain bands for operation. Shortwave broadcasting stations operate chiefly in these megacycle bands:

Roughly, at 5.960-6.200; 7.100-7.300; 9.500-9.800; 11.700-12.00; 15.060-15.450; 17.700-17.900; 21.450-21.750, and 25.600-26.085 megacycles. (A megacycle—mc is 1,000 kilocycles—kc.) Some receivers indicate these bands in *meters (m.) . . . such as the 49-, 41-, 31-, 25-, 19-, 16-, 13-, and 11-meter (or metre) bands, respectively.*

Megacycles (or kilocycles) refer to frequency; meters refer to wavelength. To convert megacycles to meters, you simply divide the frequency in mc into 300. For example: 6.000 mc (or 6,000 kc) divided into 300 gives you 50 m. (wavelength). And, conversely, 50 m. (wavelength) divided into 300 gives you 6.000 mc (or 6,000 kc) (frequency).

Many SW stations, however, *operate outside the principal ISWBC bands* which I've just described. For instance:

The 60- and 80-m. bands are used for *local (domestic) broadcasting* over relatively short distances by many South and Central American stations . . . and by stations in Africa, Australia, India, and elsewhere. These bands are often called the "tropical" bands.

The property possessed by shortwaves of *spanning great distances with strong signals* has encouraged many of the nations of the world—both great and small—to make wide use of them for broadcasting purposes.

Now, let's see what DXH monitors *scattered throughout the world* have found recently "*at their very fingertips*" through this wonderful medium of mass communication—*shortwave radio!*

LISTEN TO SPECIAL DXBC FROM 4VEH IN HAITI ON APRIL 16 AND APRIL 18

BE SURE TO TUNE-IN THE SPECIAL DXBC to be DEDICATED TO MONITORS OF DXH FROM 4VEC, 6.002, 4VWI, 9.773 (NOTE "ADJUSTED" FREQUENCIES), P. O. Box 1, Cap Haitien, Haiti, 2330-2400 GMT, SAT., APRIL 16 . . . REPEATED 0930-1000 GMT, MON., APRIL 18. A very special QSL card will be sent by the station to all SWLs who send a CORRECT report DIRECT to 4VEH. Please make your report detailed enough to be of value to 4VEH's personnel. THANKS! The b/c will feature your SW Editor, Ken Boord, a t the organ, and Ken's guests will be members of his church choir—the Spruce Street Methodist Church, Morgantown, W. Va.—of which Mrs. Mabel Howard is director—with a program of Passion Week and Easter favorites.—Ed.

FLASH! HCJB TO CARRY SPECIAL DXH BROADCAST

At press time, Ken Boord, your DXH SW Editor, received word from HCJB, "The Voice of the Andes," Quito, ECUADOR, that it also will carry the SPECIAL DX BROADCAST, dedicated to monitors of DXH, at Eastertime. HCJB will radio this SPECIAL DX PROGRAM in its "CARIBBEAN CALL" session at 2230 GMT, FRIDAY, APRIL 15, over frequencies of 17.890 and 15.115. "We send QSL cards to all those who send us COMPLETE reception reports," Ken was informed by Nancy Woolnough, English Program Director for HCJB. Send YOUR report to HCJB, Casilla 691, Quito, Ecuador, South America.

(Reports are listed in GMT—subtract 5 hours for EST, 6 hours for CST, 7 hours for MST, and 8 hours for PST. Let's go!

AFGHANISTAN—YAK, R. Kabul on anned 11.730 s-on 1500 in ENG.; light band mx; 1506 local, world N-E; (Pearce, England) Tho anncs 9.705, is actually hrd on 9.700A, noted 1700-1730 w-mx prgm, ENG. anncmts. (Elfving, Sweden, via GDX) ENG. hrd 1900-1930; 1830-1900 Fr. (Pearce) Fq is "closer" 9.703 (ALTERNATE 9.786.5 MAY BE USED IRREG.) (GDX) Hrd on 4.748A at 1425-1538; Pushtu to 1530, then ENG. for M. East; sig gets WEAKER AFTER 1500 and from day to day (Palmer, Wash. State, via URDXC) This outlet often is BEST 60-m. stn in Denmark 1530-1600 w-ENG. (Jensen via GDX)

ALBANIA—R. Tirana, ZAA, now has Fr., ENG. 2200-2300 on 7.157 ONLY; Ar. on 7.850A; veries via registered mail, enclosing picture cds frm Albania. (Mersland, Sweden, via SCDXers)

ALGERIA—R. Algeria hrd on 6.145 at 2000 in Kabyl w-N, talk abt Tunisia; SINPO 34454. (GDX) Noted in Wash. State w-s-on 0527, thru 0538 w-Kabyl (local native lingo); prior to s-on played L. Am. hand rcdg, then "L. M." and gave ID, and went right into Koran chants. (Palmer)

ANDORRA—Andorradio, 6.305, hrd "nightly" to close 2301, w-anncmts in Fr., Sp.; much pop mx; sent QSL cd, view of xmtr; sked 0600-0800, 1100-2300. (Pearce, England)

ANGOLA—CR6RN, 3.869, Luanda, hrd frm 2115 w-varied mx, both man-woman anncrs, time pips 2100, ID by woman in Pt., s-off w-"A. P." (Cox, Dela.) CR6RR, 7.070, Dundo, R. Diamang, hrd w-mx 1715. (MONITOR, ISWL) R. Ecclesia, Luanda, operates CR7RB, 4.824, 11.785, 0530-0730, 0930-1230, 1400-1600, 1730-2030 DAILY; presumably, 11.785 is used for "mid-day" xmsn. (Jones, England, via SCDXers)

AUSTRALIA—VLY25, 25.735, Melbourne, NEW EXPERIMENTAL xmtr hrd 0135-0150 w-some QSB; hrd another day 0406; beams to Asia. (Howald, Calif.)

BELGIAN CONGO—R. Luluaborg, 6.125, noted 1603-1620 in native; N-Fr. 1615. (DSWC) R. Bukavu, 4.839, sent ltr-veri, travel literature via airmail. (Pearce, England)

BELGIUM—Direct from Radiodiffusion Nationale Belge come these skeds for Overseas Xmsns thru April 30—1000-1215, 17.845; 1000-1200, 21.510, 21.730; 1215-1300, 17.845, 15.280; SUN. ONLY 1350-1500, 1500-1645, 21.510, 17.845, 21.730; 1700-1715, 17.845; 1715-1800, 17.845; 1700-1745, 15.335, 11.720; 1800-2100 (TUE. 1930-2100), 17.860, 17.845, 15.285; 2115-2300, 11.850, 15.335, 6.000; 2315-0100, 11.855 (to N. Am.), 9.705 (Af.), 9.745 (Af.), and RELAYED by OTC, 9.655, Leopoldville, Belgian Congo (to N. and S. Am.) ENG. xmsns ("BELGIAN MAGAZINE" feature) are sked SUN., TUE., THU. 2230-2300, 11.850 (S. Am.), 15.335 (N. Am.), 6.00 (S. Eu.); SUN., MON., TUE., THU., FRI. 0030-0100, 11.855 (N. Am.), RELAYED by OTC, 9.655 (N. and S. Am.). SPECIAL XMSN for Flemings in America—MON.-FRI. 2345-0030, 11.855 (N. Am.), RELAYED by OTC, 9.655 (N. and S. Am.). "THE INTERNATIONAL GOOD WILL STATION" operates over Brussels, ORU3, 100 kW; ORU4, 100 kW; ORU5, 20 kW; and frm RELAY stn, Leopoldville, BELGIAN CONGO, OTC, 50 kW. STN WELCOMES COMMENTS, CRITICISMS to RNB, B. P. 26, Brussels (Bruxelles) I, Belgium.

BULGARIA—Accdg to anncmt, R. Sofia, 9.700, has DX PRGM FIRST FRI. OF EACH MONTH (did not state time!). (Palmer, Wash. State) Noted on NEW fq OPENING 0000 in Sp.; IS precedes actual s-on; presume is directed to L. Am.; gud level but "squeezed."

BURMA—BBS, 4.795, hrd to 1500 s-off in Burmese. (Palmer, Wash. State, via URDXC) Hrd on 9.640 at 1500-1518 s-off w-E-N; strg sig; few days later WAS BACK ON 6.015, hrd 1430 and w-E-N 1500 (QRM'd by VUNC). (Balbi, Calif.)

CANADA—The Int. Serv., CBC, Montreal, Quebec, observed its 15th anniversary Feb. 25. (SCDXers) CFRX, 6.070, Toronto, Ont., has "brand-new" QSL-cd which includes "definite" verification—checks EITHER CFRB (MW) or CFRX (SW), depending on channel RPTD. (Roth, Conn.)

CEYLON—R. Ceylon, 15.265, Colombo, Commercial Serv., noted w-"Home News" 0200A. (Boice, Conn., Whitaker, Ind., others) (Formerly took BBC news RELAY 0200.—Ed.) Commercial Serv., 4.870, fair arnd 1430 w-ads, variety program; NOT parallel 9.520, hrd same time w-prgm of SIMILAR FORMAT. (DXHCNE) "Native" Commercial Serv., 15.120, hrd in Hindi, Tamil to S. India 0310-0350; sked to 0430 s-off but deteriorates badly in quality AFTER 0400; features native-type mx, ads, and 3-note chime "breaks." (Palmer, Wash. State, via URDXC)

CHINA—R. Peking's H. Serv. strg in Calif. 0900 s-on over 6.000. S-on 17.900, 15.020, 15.290 in lingo 0100; 17.900 outlet hrd in Ar. 0400 RELAYED frm Moscow parallel 15.130. (Balbi) Hrd in ENG. 0330-0400 on 17.745, steady S8 sig in Ont. (White, Canada) R. Peking, 6.125, hrd in Chinese dialect w-"National Minorities Serv." 2253-2258 s-off. REGIONAL STN, Changsha, Hunnan Province, hrd on 4.990 in Chinese to 1500, but NOT past that time, tho WRH60 shows sked to 1530; ID seems to be "Human yen ming kwang po tien tai." (Palmer, Wash. State, via URDXC) ORIENTAL spkr on 6.279 at 2345 w-exercises by man in dialect, possibly Uighur, and instru accompaniment, is believed Urmuchi, Sinkiang; 2356 woman took over and stn cont'd PAST 0000; time pips 0000; still READABLE LATE as 0105, seemingly then in Chinese; peaked 2355-0010. Yunnan, 10.037, noted frm 2250 w-Chinese mx, lingo; exercises 2310, anncd by man; peaked 2300-2315. (Cox, Dela.)

CLANDESTINE—R. Cairo, 17.915A, EGYPT (UAR), is significantly "silent" 1700-1745 (AFTER Amharic b/c to Ethiopia) "while" CLANDESTINE "Voice of Free Africa" (location of which has DEFINITELY BEEN ESTABLISHED AS "WITHIN UAR'S BORDERS," accdg to a leading USA news weekly mag) "raves and rants" in Swahili after s-on w-drums 1700, w-ID "Hihi Sautu ya Africa Hurru" to 1745 s-off. Then, R. Cairo resumes operations on 17.915A at 1745 w-clock chimes, Nat. Anth., opening in Somali. (Palmer, Wash. State) (Draw YOUR OWN CONCLUSIONS!—Ed.) Roth, Conn., rpts stn on 7.030 hrd 2300-2310 recently w-ENG. "against Mr. K" of the Soviet Union; pop mx; may have been a HAM "hammin' it up," hi! CLOSED ABRUPTLY 2310. Cox, Dela., recently logged what "seemed" to be "Radio Socialiste Albania" on 6.995M at 2130 w-nx in Albanian which ended 2138, then had 2 min. pause, and man took over; sig fair but had CWQRM much of time.

CONGO REP.—R. Inter-Equatoriale, 4.795, Brazzaville, recently REMAINED ON AIR (SAT.) PAST sked 2100 s-off; CLOSED 2112 w-"L. M." after final ID in Fr. by man anncr. (Cox, Dela.) R. Brazzaville s-on 1810 on 11.725, 9.770; ENG. 1815-1830, then Pt. (Pearce, England) On 11.725 hrd ASKING FOR RPTS TO ENG. FEATURE "American Letter Box," hrd 0130-0145 SAT. to Wn. Hemisphere. (Niblack, Ind.) Hrd on 21.500M, excellent 1800 w-final ID in Fr. by man, then s-off w-"L. M." (Cox)

COOK IS. (N. Z. Territory) — R. Rarotonga, ZK1ZA, 4.965, noted THU. ONLY 0445-0510 (OR 0520) w-songs in Polynesian; E-N 0505-0510. (GDX Accdg to WRH60 sked is THU. ONLY 0430-0530 w-E-N 0510; IS is Cook Is. drum beats; varies by QSL-cd frm Further Education Radio Serv., Rarotonga, Cook Is. (N. Z. Territory).)

CZECHOSLOVAKIA — Direct frm Martha Trojanova, Ed., N. Am. B/C, R. Prague, Prague 12, Czechoslovakia, via airmail comes a LOTTERY TICKET and word that R. Prague WILL SEND A SIMILAR TICKET "TO ALL LISTENERS WHO SEND US RECEPTION REPORTS OR LETTERS; a listener may receive MORE THAN ONE ticket, of course. This big prize-winning lottery is being conducted during the 15th anniversary of the Peoples' Democratic Czechoslovakia. WINNING NUMBERS WILL BE DRAWN IN JAN. 1961, AND THE RESULTS WILL BE ANNOUNCED

in Prague b/c AND IN LETTERS TO THE WINNERS. FIRST PRIZE IS A FREE HOLIDAY IN CZECHOSLOVAKIA IN 1961. There are many other attractive prizes. EVERY LETTER TO R. PRAGUE THIS YEAR WILL GET YOU A LOTTERY TICKET." Cushen, N. Z., observes Prague on NEW off-band fq 7.340A, strg in N. Z. 0500-0531, parallel 9.550, 9.660, 11.740, 11.840 in ENG. (Believe beamed to N. Am.—Ed.) Via SCDXers, Meller, Finland, advises that the ENG. DX-PRGM is EVERY FIRST TUE. OF MONTH in Eu. beam 1900-1930, REPEATED 2000-2030 on 7.185, 9.550. (I presume this is ALSO carried NEXT DAY—GMT—in N. Am. xmns.—Ed.)

DUTCH NEW GUINEA — FLASH! — Balbi, Calif., was the first to rpt to DXH R.O.N.G., Biak, on NEW 6.074AV, hrd s-on 0900 AND ANNCG for 3.735; 6.074AV is POWERFUL LEVEL in Calif., 3.735 WEAK AFTER 1100; 6.074AV outlet strg yet at 1215 recheck. For ECNA SWLs, your SW Ed. suggests "best bet" is to tune 6.074AV on SUN. frm 0900 s-on; has RELIGIOUS SERVICE 0930; excellent level in W. Va. to AFTER 1100, but w-considerable het-QRM, tho is COMPLETELY CLEAR of CFRX, 6.070, Toronto, Ont., Canada. Noted in N. Z. by Cushen but w-much sideband QRM there frm ZL7, 6.080, Wellington. Accdg to WRH60, power is 5 kW, BUT CURRENT SIG WOULD INDICATE "MAY" BE ONE OF PROJECTED NEW HIGHER-POWERED XMTRS! Annces "Hier is Biak, Radio Omroep Nieuw Guinea"; QRA is P. O. Box 505, Biak.

EGYPT (UAR) — R. Cairo now noted on 7.050 in Ar. S9+ arnd 0000 to AFTER 0130; ID "Huna El Kahira." (Boice, Conn.) Noted on this channel in Ar. to Sudanese population to 1622 s-off; reopens 1625 w-"Voice of the Arabs" b/c. Hrd on NEW 17.690A outlet in W. Af. Serv. 1700-1800 in Hausa (Hausa is the dialect spoken in the "up-country" of W. Af.; Hausas were ancient people who came from the North to settle Ghana, Togo, Dahomey, Nigeria, centuries ago); 1800-1830 ENG., 1830-1900 s-off Fr. (Palmer, Wash. State, via URDXC, Balbi, Calif., Roth., Niblack, Ind., others)

ENGLAND—The card that the BBC is sending out with the picture of BIG BEN on it is PURELY AN ACKNOWLEDGEMENT CARD and is NOT A VERIFICATION. The BBC's policy in respect to verification is UNCHANGED. (ISWC) FLASH! — Accdg to a news dispatch frm London, the SOVIET UNION has fulfilled a two-month-old promise and ENDED MASSIVE JAMMING OF BBC'S RUSSIAN-LANGUAGE PRGMS. The NEW POLICY apparently has NO EFFECT ON OTHER RUSSIAN JAMMING OPERATIONS WHICH ATTEMPT TO BLOCK THE VOA, RFE FROM REACHING THE EARS OF SOVIET (AND SATELLITE) CITIZENS. Incidentally, JAMMING BY THE SATELLITE NATIONS CONTINUED "AS USUAL"! (Balbi, Calif.) Commenting on this NEW DEVELOPMENT in GDX-aren (Feb.), an official of GDX, Sweden, said in part: "A few days ago the papers said the Russians stopped jamming; well, not all jamming—such luck will not happen in our lifetime (?)—but it does seem that BBC xmns to Russia WERE FREE FROM JAMMING—for how long? It is also said that the BBC USED LESS FQS. THAT MEANS THERE WILL BE MORE SPACE FOR DX—THANKS! BUT the Communist propagandists

used 400 (?) hrs MORE EVERY WK DURING 1959 THAN BEFORE!—2,921 hrs per wk frm the EASTERN BLOC—only 2,530 hrs in 1958. Comparative figures for PAST TWO YRS are—Soviet Union 975 (916); satellites 220 (166); CLANDESTINES (Esp. Indep., Voce dell Istria, etc.) 154 (133). TOO MUCH NOISE! And—as YOU KNOW—THERE IS A LOT OF JAMMING, TOO!—how many hrs every wk?—more than 2,921?”

NEW BBC fq 18.080 to N. East in Ar. hrd 1545 s-on to 1800 s-off; RATHER THAN LISTED 17.700, BBC carries GOS to SE Asia, India, Pakistan, Ceylon on 17.693A; hrd frm as EARLY as 1600 to 1815 s-off. (Palmer, Wash. State, KBLP)

ETHIOPIA—The LUTHERAN WORLD FEDERATION has been authorized by the Ethiopian Govt. to set up a radio stn in this African Kingdom; Federation plans to establish a b/c unit capable of reaching ALL PARTS OF AF., W. and S. ASIA; authorization is said to be the first granted by Ethiopia to a private agency. (THE NEW YORK TIMES via NNRC, West, N.Y.) R. Addis Ababa, 6.185, 7.290, 9.610, sked in ENG. 1030-1100, 1615-1630, and w-“international” mx prgm 1900-2000; SUN, 1000-1100, WED., MON. 1030-1100. (Watson, England, via ISWC) Despite his wonderful rcptn location nr the Arctic Circle in northern Sweden, Sven Elfing rpts direct to DXH that he is UNABLE TO LOG R. Addis Ababa on EITHER 9.617A or 15.345 at 1900-2100; says 9.615A is VOA-TANGIER and on 15.345 he “finds” LRA, Argentina.

FIIJI (British)—The Fiji Is. B/C Comm. has purchased 30 acres nr Suva, capital, and will build a NEW B/C HOUSE for 3 BCB xmtrs (600 w., 2.5 kW); 3 SW xmtrs (TWO 10 kW, one EMERGENCY, 500 w.) Will employ VERTICAL-INCIDENCE, HIGH-FQ systems in 75- and 60-m. bands. (AMSWLC, via Roth, Conn.) IS is beat of Fijian Lali (log drum); varies via QSL-cd—“but not sought!” (WRH60)

FRANCE—RTF, Paris, has REPLACED 9.775 w-7.280 at 0600-0745 s-off; badly QRM'd by hams. (Balbi, Calif.) (May be SUN., same hrs, too?—Ed.) FLASH—RTF, 21.620, strg 1300-1315 w-E-N by man, then into Fr. (Cox, Dela.)

FR. GUIANA—R. Cayenne, 6.170A, noted w-man-woman in Fr. to 0100 ID, then s-off w-“L. M.” (Gibsons, Calif.) Sked w-1 kW 1015-1115 (SUN. 1100-1400), 1645-1745 (SAT., SUN. 1630-1800), 2230-0100 DAILY. (WRHB)

GABON—R. Libreville, 5.025, has been SURPRISINGLY GOOD STRENGTH recently hrd frm 1730 s-on to 2100 s-off (SAT. 2200); at times QSA 4-5 but usually w-vy heavy CQWRM. (Magnusson, Sweden, via GDX) Anncs 5.040 BUT ACTUALLY HRD ON 5.025; noted OFTEN 2000 w-light, soft mx. (Elfving, Sweden, via GDX)

GERMANY (EAST—GDR)—R. Berlin-International, 11.755, s-on in Ar. 1100. (Pearce, England)

GERMANY (WEST—Fed. Rep.)—DW, Box 334, Koln (Cologne), Germany (Fed. Rep.), will send SKEDS FREE ON REQUEST. (Mann, Wisc.) Voice, Conn., rpts RIAS, 6.005, Berlin, tuned 0146 “Hier ist RIAS Berlin, N-Ger. for 5 min, then dance w-uninterrupted “old” dance selections to 0200, ID mx again until was “buried” in QRM arnd 0210.

GHANA—ZOY, 3.366, Accra, hrd w-E-N 1800; 1815 Af. dance mx. (Pearce, England) The 9.640 outlet is hrd DAILY EXCEPT SAT.; sometimes is “like a local” in Calif. 0730-0900A, and often fea-

tures transcriptions frm BBC, R. Nederland BEFORE 0800—when ID as “Radio Ghana” and gives time as “8 a.m.” (same as GMT). (Balbi)

GREECE—R. Athens, 9.607, hrd w-IS, then s-on 0550 (SUN.); gud level in lingo. (Niblack, Ind.) Greek Forces Stn, 7.162A, Sarrai, can be hrd in Japan when VOA-OKINAWA, 7.160, Naha, closes 1630, to 1930 s-off w-Greek Nat. Anth.; N-Gk. sked 1735. (JSWC) (Is this a NEW outlet of FBS? Do NOT find it LISTED in DRH60—Ed.) FBS, 7.214, Kavalla, opens 1000 w-trumpet IS, ID of “Edho Kavalla”; FBS, 7.950, Kozani, gives gud rcptn in N. Z., PARTICULARLY SUN.

GUINEA REP.—FLASH!—Accdg to an item in NEWSWEEK, a \$25-million xmtr will be built for the Guinea Govt. w-SOVIET MONEY AND TECHNICIANS; WILL BE POWERFUL ENOUGH TO COVER ALL OF AF. FROM CAPE TOWN TO ALGIERS! (Balbi, Calif.) (SOUNDS LIKE A LOT OF MONEY—but is EXACTLY WHAT THE “CLIPPING” STATES! —Ed.) R. Conakry, 4.910, gud level in Fr. 0650 w-drums, talks, ID. (Bromley, Ont., Canada, via AMSWLC)

HAITI—FLASH!—“The Evangelistic Voice of the West Indies” is TESTING new, higher-powered xmtrs on NEW fqs (as “adjusted”) of 4VEC, 6.002 and 4VWI, 9.773; WANTS RPTS FROM ANYONE ANYWHERE IN THE WORLD—to P. O. Box 1, Cap Haitien, HAITI. (Saylor, Va.; KBLP) Has NEW prgm called “YOUR GOSPEL HOUR,” FRI. 1030. (Saylor) R. Hait, 4VHW, 6.200, Port-au-Prince, hrd SUN. 2315 (NOW 15 MIN EARLIER than formerly) w-ENG. “Musical Caravan”; says is also presented THUR. (Roth, Conn.) NEW 49-m. xmtr of R. Caribe, Port-au-Prince, is NOW on 6.009 w-c/s 4VEB; BEST TIME TO HEAR is 1030 s-on. (NNRC) 4VU, 3.325, Cayes, gud 0228 w-religious prgm, Fr. ID by man; s-off 0232. (Cox, Dela.)

HOLLAND—THE HAPPY STATION PRGMS ON SUN., prepared and presented by veteran “Ambassador of Goodwill” . . . the multi-lingual Eddie Startz are CURRENTLY sked 1030-1200 to F. East, Eu., 21.565, 15.220 (6.020 to Eu.); 1600-1730 to India, Af., Eu., 25.610, 21.480, 17.775 (6.020 to Eu.); 2100-2230 to Spain, S. Am., 15.220, 11.730 (6.020 to Eu.), and 0200-0330 to N. Am., 11.915, 6.025.

HUNGARY—R. Budapest has DROPPED 5.975. (Hengel, Germany, via SCDXers) Hrd on 9.833 at 0407 w-“World Magazine” feature. (Whitaker, Ind.)

INDIA—S. M. Muzumdar, for Direction of External Services, New Delhi, informs your SW Ed. that ALL CORRECT RPTS ARE VERIED w-QSL-cd; no return postage necessary. JSWC rpts AIR, 4.940, Guahati, hrd in Japan 1500-1545; E-N 1530. Cox, Dela., rpts AIR, 4.820, hrd 1237 w-woman in native news, vocals 1240, parallel Lucknow, 4.878; 4.820 “may” be Bhopal. Palmer, Wash. State, via URDXC, reports AIR, 4.988, Hyderabad, hrd 1525-1535 w-native-type mx; anncd in ENG.: “This is All India Radio, here is the news” 1530, and E-N followed. AIR, 4.920, Madras, w-xmtr “B” programming, hrd 1510-1529 when was “wiped out” by T-T QRM; typical S. Asian mx; lingo UNID due POOR QUALITY OF SIG. From Ind., Niblack flashes he is hearing AIR on 9.530 w-native mx, anncmts by woman 2345; possibly Calcutta, and that AIR, Delhi, is hrd on 9.705 CURRENTLY w-E-N 0230.

INDONESIA—The EN. xmsn frm RRI, 9.595A, Djakarta, can NOT be hrd in Ont., Candada, due to POWERFUL RUSSIAN XMTR ON CHANNEL; however, the 1900-2000 ENG. b/c on 11.785 (NOT 11.795A, as rpt by some sources); hrd regularly; IS is bird chirping. (Stanbury via URDXC) Djakarta, 7.290, UP FRM 7.285, s-on 1100 w-ENG. xmsn to Australia-N. Z.; E-N 1115, 1445; parallels YDF6, 9.595A, YDF2, 11795A; Indonesian hrd on 9.555 AFTER 0900, strg and parallel 9.545 (QRM'd there by R. Peking, 9.550). (Balbi, Calif.)

INNER MONGOLIA—R. Huhentol lately noted using 9.093 outlet; hrd 2240 w-man-woman in Chinese; completely faded out by 0050; peaked 2255-2310. (Cox, Dela.)

IRAN—R. Teheran observed opening 1230 on 7.285, anncd "Injah Tehran"; apparently, this channel is used IRREG. (DXHCNE)

IRAQ—R. Baghdad, YIH62, 6.030, now has ENG. 1 hr later—2100. (Roth, Conn., Pearce, England, others) Commentary 2115, s-off 2127A. (Cox, Dela., Ferguson, N.C., others) Hrd in Wash. State 1510-1635 but NOT in Ar. as most DXers rpt; is in SIMILAR lingo, probably Kurdish, which IS sked on 3.297 then; YIH32, 7.180, hrd 1610-1620 in Ar. NOT parallel 6.030; this xmsn is H. Serv. (Palmer) The 6.030 channel hrd w-Ar. fading-in frm 1945-2030, Ger. 2030-2100, ENG. 2100-2127A s-off; ID: "This is Radio Baghdad, the Broadcasting Service of the Republic of Iraq." (Berg, Conn.)

ISRAEL—At the recent inaugural of Kol Israel's b-c to W. Af. (2115-2145 ENG., 2145-2215 Fr. RELAYED frm Jerusalem via Tel Aviv, 9.009), Mrs. Golda Meir, Israeli Foreign Minister, said: "All of us speak the common language of young nations dedicated to the great endeavor of giving true, full meaning to self-government. Israel has been proud to welcome a steady flow of visitors from many African lands." Aason George Reeves, Liberian Charge d'Affaires, commented that "this Service is an objective approach to creating the environment for developing true friendship, mutual understanding, and cooperation between Israel and the peoples of West Africa." (ISRAEL DIGEST via DSWC) Kol Israel hrd on NEW 9.727A channel parallel 9.009, Tel Aviv, 2100 c-d; 9.727A is NOT MENTIONED IN CLOSING ANNCMNTS. (Niblack, Ind.) Hrd in ENG. on 9.009 at 2030-2100. (White, Ont., Canada)

ITALY—RAI, 11.905, Rome, hrd w-It. 0145-0205; strg sig in Ind. (Whitaker) Noted on 21.560 at 1638 w-operatic-type mx. (Howald, Calif.)

IVORY COAST—R. Abidjan, 4.940, has N-Fr. 0645, followed by mx 0700; "snatches" of "William Tell Overture" seem to be played as signature tune; b/c "evenings" to 2230 (WKDAYS; 0000 SUN.). (ISWC)

JAPAN—Nippon Hoso Kyokai (Japan Broadcasting Corporation), Tokyo, JAPAN, seems to be the "simple" OFFICIAL QRA now in use for R. Japan, accdg to ltr direct frm stn. (KBLP) JOZ, Nippon Tanpa Hoso, 3.925, Tokyo, COMMERCIAL stn, hrd to s-off 1525; all-Japanese and uses native stringed instru in descending scale for signature tune; parallels JOZ2, 6.055. (Palmer, Wash. State) FEN, Tokyo, sent nice, colorful veri-cd for rcptn of 11.750. (Roth, Conn.) FLASH!—Noted on 3.800 at 1510-1535 in ENG. w-usual programming; OUTLET IS NOT LISTED IN CURRENT SKEDS FRM FEN! (Palmer, Wash. State)

JORDAN—Amman, 6.020, hrd s-on 0700 in Ar. (Niblack, Ind., Saylor, Va.) Audible in Calif. in Ar. 1500-1530. (Balbi)

KOREA (N.)—R. Pyongyang, 6.250, hrd frm 2210 w-native vocals, woman in Japanese; gud, clear sig; 2215 talks or discussion by two girls and man; 2230 sounded 8-note chime IS (G-E-F-G-C-E-F-G) then cont'd in oriental lingo; chimes again 2300 when was DOWN TO POOR LEVEL; peaked 2200-2230. (Cox, Dela.)

KOREA (S.)—HLK8, 15.410, Seoul, hrd well 1400-1430, ID "Voice of Free Korea" and "Overseas Service of the Korean Broadcasting System"; dual HLK5, 9.640. (Roth, Conn.) HLK4, 7.180, can be tuned in N. Z. frm 0900 in Korean w-WX forecast 0900, nx 1030. (Cushen) Seoul, 11.745A, 17.745A, hrd w-ENG. to N. Am. 0530-0600, then Korean; E-N 0530-0540, talk to 0555. (NNRC)

KUWAIT—By now, R. Kuwait should be b/c over 1,130 kc, 1,344 kc, and SW 9.648 (NEW). (Kishinoue, Japan, via JSWC)

LIBERIA—ELWA'S NEW 50-kW xmtr was FIRST ON THE AIR at full power at 10:05 a.m. LOCAL TIME on Dec. 21 last. On Jan. 4, the FIRST EXTENDED B/C was made, celebrating its own inaugural by maintaining a LIVE b/c throughout the 4-hr presidential inaugural ceremonies in the Centennial Memorial Pavilion in Monrovia. This was b/c by a FM link to the local audience on ELWA's 10-kW xmtr, and out across Af. on the NEW 50-kW job. First rcptn rpt rcd (via ELWA's fixed-fq radio contact w-Jos, NIGERIA, 2,000 mi, frm ELWA) was the short but MEANINGFUL statement: "PLENTY OF POWER!" When xmsn lines are completed between the 50-kW xmtr and the 60-m. and N. Am. antennas, the NEW xmtr will be hrd in REGULAR SERVICES. The N. Am. Serv. is TUE. 2300-0045 and REPEATED WED. 0100-0245. Fqs to WATCH are 15.200A, 11.986. A 1-kW xmtr operates parallel on 21.515. Chief Engineer E. Christopher Cone of Radio Bolahun, Holy Cross Mission of the Episcopal denomination in Liberia's WESTERN PROVINCE, has rcd authorization to b/c on SW w-500 w. w-DAILY sked of 3 hrs. ELBC FORMALLY OPENED its two 10-kW xmtrs (SW AND BCB) on Jan. 1; this is the FIRST FULLY COMMERCIAL B/C OPERATION in ENG-spk W. Af. (NNRC) (Full details of operations are wanted!—Ed.) MUCH-IMPROVED sig observed from ELWA's 4.770 outlet 0640-0800 DAILY vnm, BBC-N EASY TO READ 0700. MAY BE USING THE NEW 50-kW in this xmsn? (Balbi, Calif.) Hrd s-on 0530 on NEW 11.825A channel in xmsn to W., C. Af.; 0600 Fr.; usual religious prgms. (Niblack, Ind.) Hrd to 0630 s-off, badly QRM'd by WDSL (Balbi) The 11.986 outlet EXCELLENT in W. Va. in N. Am. xmn cited earlier herein. (Dalton; KBLP)

LIBYA—Benghazi, 9.893, noted in Fcb. AS LATE AS 2158 s-off; all-Ar. w-mostly chanting; 3.304 outlet NOW HAS MUCH-IMPROVED SIG, hrd 2130 and 0530 recently. (Cox, Dela.)

LUXEMBOURG—R. Luxembourg, 15.350A, BEST rcptn of H. Serv. in Fr. 1100-1400; QSA 5. (GDx)

MALGACHE REP. (Madagascar)—R. Tananarive, 3.230A, strg in Calif. 0940 tune-in w-native prgm. (Howald)

MARTINIQUE—In addition to 5.994A, R. Martinique, Fort-de-France, b-c 1015-1130 on 3.315;

1615-1745, 4.895, 2230-0125A, 2.420. (Jones, England, via SCDXers) Hrd on 5.994A outlet on a MON. w-EXTENDED SKED to 0250 s-off. (Niblack, Ind.)

MAURITANIA (Senegal — Fr. W. Af.)—R. Mauretanie, 4.855, opens 1943 DAILY w-IS, guitar-mx, then call in Fr. and mx prgm in Fr. (Elfving, Sweden, via GDX) Hrd in Wash. State 0723-0751 in vernacular; POWERFUL LEVEL. (Palmer)

MAURITIUS—It is believed the Mauritius b/c stn suffered severe damage (probably is off the air yet?) from "the worst cyclone in the island's history; the storm raged Jan. 18-19 when the island was struck by 120-m.p.h. winds, destroying 6,000 homes and buildings, greatly damaging 3,000 more; demolishing power, communication lines; destroying crops and produce; 12 inches of rain fell during a SINGLE DAY; the storm loosened foundations of structures which were then swept into the sea by gale-force winds. It will take Mauritius a long, long time to recover from this catastrophe," accd to a Mauritius correspondent to Gibson, Calif. ("R. Mauritius is probably still 'lookin' for its antenna tower!" Gibson comments.) From "the Land of the Midnight Sun," at Ornskoldsvik, a small town near the Arctic Circle, located on the East Coast of Sweden, 400 mi. north of Stockholm, Sven Elfving, one of Sweden's top-notch and most successful SWBC DXers, rpts direct to DXH that despite his excellent rcptn location, he has been "unable to raise" R. Mauritius on 3.325A; bad QRM frn Kaduna, 3.326, Nigeria, prevails! (However, GDX says stn recently verified—probably this was BEFORE the "big storm" struck—and said 15.062 was DROPPED IN NOV.; cited use of 10-kW xmtr w-Domestic Serv. 0300-0415, 0800-0900 on 6.101, 1300-1730 on 3.365.)

MONACO—FLASH!—Literature rcd frm former "Voice of Tangier" (Morocco) indicates WILL RETURN TO AIR PROBABLY AT BEGINNING OF MAY over HIGH-POWERED xmtr at Monte Carlo as "TRANS-WORLD RADIO." (Pearce, England) Will be 100 kW! (Buettner, Germany, via WRHB) FLASH!—TEST xmsns frn R. Monte Carlo are now sked on 11.765 MON. 2200-2305, TUE. 0500-0545 WED. 2200-2305, THU. 0500-0545, FRI. 2200-2305, SAT. 0500-0545, 2200-2300; SUN. 0520-0545, 2200-2355, MON. 0515-0545. (SCDXers)

MONGOLIAN PEOPLES' REP.—R. Ulan Bator, 6.345, weak-fair in language 1225, ma anncr; QSB, CWQRM. (Cox, Dela.) Tabuchi, Japan, says R.U.B. is now wkg on 6.345, 7.275, 10.337, opening 2300; hrd also 0800-1500. (JSWC, WRHB)

MOROCCO—Ltr frm Rabat confirms that 5.968 is NOT 1 kW, but 10 kW; sked Ar. 0645-0900, 1200-1500, 1700-0000, 5.968, 15.205; Fr. 0645-0945, 1200-1400, 1830-2300, 6.005, 7.215; Berber 0645-0800, Sp. 1200-1245, 1930-2000, ENG. 1245-1300, 7.214. TANGIER FORMALLY GOES TO MOROCCO ON APRIL 19 AND LOSES ITS "INDEPENDENT CITY" STATUS. (Berg, Conn.)

MOZAMBIQUE—Recently, Lourenco Marques was hit so hard by a storm that R. Clube de Mocambique, 11.760A, was "knocked out of commission" 0435A; when resumed operation after 3 min of "dead air," pop anncr David Daly explained reason, gave vivid description of storm's violence, which included severe lightning, then anncd "change-over" in sked—that 60-m. xmtr would henceforth be "5 to 8 a.m." (0300-0600

GMT); 60-m. outlet is presumed to refer to 4.840 (as rptd recently by Stark, Texas, Cox, Dela.—Ed.) (Gibsons, Calif.) THE VERY RARELY HRD OUTLET of R. Clube de Mocambique, 4.859, was hrd recently parallel 3.301, both used DAILY 2000-2100 ONLY; religious prgms in ENG. to 2045 then same prgm in Afrikaans; 3.301 QSA-K 3-4 at best in Sweden; 4.859, QSA-K 4-5. (Elfving via GDX)

QUERY!—At deadline, Margie Gibson, Calif., FLASHES: "WHO IS THE LUSCIOUS-SOUNDING BABE who is now splitting time w-DAVE DALY frn L. M. (11.760A arnd 0415)? Have been hearing her for several days lately; sounds like a combo of Marianne of R. Denmark, the 'barefoot' gal from Bukkitting, and the really 'sexy-gal' from R. Congo Belge (9.383A s-on 0500). She's a wonderful NEW ADDITION to listening—Hubby John, darn his hide, even agrees with me! But she really is fun to listen to! Seems to 'take over' about 0415, and is really a 'dilly'!"

NEPAL—Accd to a news dispatch in the INDIA EXPRESS, R. Nepal soon will be on the air REGULARLY (should he hrd well in India) w-NEW 5-kW xmtr purchased frn Brazil; only a "small" xmtr is now functioning at Kathmandu (QRA is "Via India") in H. Serv (LISTED by WRH60 on 6.004, WED. 0320-0450, 0750-0920, 1130-1250, w-N-E 0435, 1245; BUT MAY TEST ALSO ON FORMER 7.100 OUTLET—Ed.)

NEW ZEALAND—Your SW Ed. had the pleasure on March 2 to listen to the MONTHLY DX PRGM ("This Radio Age"—radiated the FIRST WED. OF EACH MONTH at 0815, REPEATED 1030 over R.N.Z., ZL7, 6.080, ZL4, 9.540) when TAPED HIGHLIGHTS frn the ANNUAL CONVENTION of the NEW ZEALAND RADIO DX LEAGUE, held in Christchurch in late Feb., were presented. Included were TAPED MESSAGES to the League frn R. Japan, SBC, Graham Hutchins (DX Ed., R. Australia), and others—including "the Dean of active USA SWLs," August Balbi of Los Angeles. Incidentally, Balbi notes ZL4, 15.280, s-off 0615; re-opens 0630 over ZL2, 9.540, ZL7, 6.080. Cox, Dela., notes ZL4, 15.280, at 1915 w-WX rpt, meat prices 1917, and time check 1922 for "22 past 1"; BBC nx 2000; gud sig thruout. Howald, Calif., flashes that this one fades in sooner now on WCNA—hrd 0155 w-luncheon mx; sig much improved and prgms are "very entertaining," he comments.

OUTER SPACE!—The satellite "EXPLORER VII" was hrd some wks ago 1600-2100 on 19.990.3, three times for 15-20 min; has modulation of 4-5 different changing tones; formerly was able to get this one on ONLY 108 mc, so it seems that small meteor may have "repaired" its antenna, hi! (Uthoff, Germany, via GDX)

PAKISTAN—APL, 7.095, Lahore, weak 1240 w-native-tone mx, language, Dacca, 7.140, hrd 1250, weak, news in lingo. (Cox, Dela.) Pakistani outlet 3.240 closing 1700 is presumed to be APL; N-E 1630-1645, then native talk to s-off w-Nat. Anth. (DXHCNE) APK, 15.275, Karachi, hrd w-SINPO 55555 frn 1030-1045 in GOS w-dictation-speed N-E.

PHILIPPINES—On Feb. 14, Balbi, Calif., hrd "very interesting" b/c of DEDICATION of FEBC's NEW 50-kW xmtr, buildings (0945-1055—excellent mx scripture reading, invocation by the Rev.

Mr. Roberts; prayer; talk about "Voice of Freedom and Truth" and "Voice of the Philippine Islands," and arnd the world; founded 14 yrs ago; speech by Mr. Broger, FOUNDER OF FEBC, who has traveled 100,000 mi. and MADE CERTAIN TO BE ON HAND FOR THE DEDICATION; mentioned 12th xmtr of FEBC now on OKINAWA, and said soon will have 14th, 15th xmtrs "broadcasting the message" to ASIA—WILL BE THE LARGEST PRIVATE B/C stn in the world; mx by Marine Band; talk by Atty. Leon Otee, dedicating "this Christian Radio Station to 35 countries and languages to all corners of the earth"; next was the Guest of Honor, Home Secretary of Defense for the Philippines Sanchez, Senior Official of "this Province," who lauded President Garcia; talked by P.I. during WWI 1941-45; ADDRESS followed by Sr. CARLOS GARCIA, PRESIDENT OF THE PHILIPPINES, about "faith, confidence, and so on"; THANKS, then PHILIPPINE NAT. ANTH. at 1053A s-off of SPECIAL DEDICATORY B/C.

NEW is "The Voice of the State University," operated by the State University of The Philippines, Quezon City, 0900-1300 EXCEPT SUN., over DZUP, 1,580 kc, 2 kW, and 7,240, 0.5 kW; all-ENG. EXCEPT 0930-1000 when Tagalog is featured. DZWS, 9,310, Manila, is AUDIBLE IN JAPAN frn abt 1800, mostly w-anncts in ENG. EXCEPT 1845-1900 and, occasionally, 1830-1845, when uses Tagalog; s-off 0100 w-Nat. Anth.; HEAVY T-T QRM. (Tabuchi via JSWC, WRHB)

REUNION (Fr.)—R. Reunion, 3,395 (LISTED 3,380 by WRH60—Ed.), hrd in Sweden 1655. Verie ltr rcd via airmail. (Elfving) QRA is B. P. 309, St. Denis. (WRH60)

RHODESIA AND NYASALAND — Salisbury, 6,020, weak w-QRM 2030-2100. (Bromley, Ont., Canada, via AMSWLC). In verifying by ltr, Salisbury's Federal Broadcasting Corporation advised DOES NOT ISSUE QSL CDS. (Roth, Conn.)

SAO TOME—Sao Tome, 4,807, hrd 2020, R5-S9. Elfving, Sweden)

SAUDI ARABIA—Within 2 yrs, Mecca (RE-LAYED BY DJEDDAH) will have 2 NEW stns—one each at Djeddah and Riyad—including powerful xmtrs w-total strength of 250 kW. (Shiek Ibrahim el-Shura, Gen. Dir. of B/C, Djeddah, via SCDXers)

SENEGAL (Fr. W. Af.)—R. Mali, 4,950, Dakar, hrd 0631-0751 in Fr. R. Senegal, 4,893, Dakar, noted 0725-0751, appeared to be Fr. to 0730, then in vernaculars. (Palmer, Wash. State)

SINGAPORE—R. Malaya has RETURNED to old fq 4,820, hrd 0930-1230 in Tamil, 1230-1530 c-d in Malay, w-same prgms as 6,135, 6,025 (Kuala Lumpur, MALAYA); also OPENS on NEW 6,015 outlet, LOCATION UNKNOWN YET, 2230 in Malay, which channel is ALSO observed in Japan 0930-1530 (ENG.). (Tabuchi via JSWC, WRHB) R. Malaya, 7,200, hrd 1430-1530 c-d in ENG. (Dannel, Sweden, via GDX) FLASH!—EVIDENTLY NEW outlet of R. Singapore noted on 4,780, hrd in ENG. w-vy clear ID 1430 w-s-off annct; said b-c DAILY in Tamil, Chinese, Malay, ENG.; no anthem at close. (Palmer, Wash. State, Balbi, Calif.) ID for "Radio Malaya" at c-d; ENG. observed 1400-1430, also hrd in language 1100-1200, fair sig; 6,015 outlet hrd 1100-1200 w-QRM frn Burma. (Balbi)

SPAIN — RNE, Madrid, currently noted on 6,009.5; strg 2047 w-man in Sp.; the 41-m. band outlet currently is 7,106. (Cox, Dela.)

SUDAN—R. Omdurman noted MOVED to 9,540M, fairly in clear at rather easy listening level 0430 w-ID in Ar. (Niblack, Ind.)

IBRA-Radio, FORMERLY AT TANGIER, MOROCCO, at present radiates Fr. frn stn at Bukavu, BELGIAN CONGO; Japanese frn R. Kanto, Yokoham, JORF, 1,480 kc, JAPAN, 10 kW, SAT. 2130-2145; Sp. frn stn in PARAGUAY and ANOTHER in Cochabamba, BOLIVIA; "La Cruz del Sur" ("The Southern Cross"), CP27, CP38, BOLIVIA, soon will radiate IBRA-prgms in ENG., Ger., Pt., Sp. (POWER OF THIS STN WILL BE INCREASED FRM 1 to 10 kW). (WRHB) Is MAKING EFFORTS TO GET COMPLETE SKED OF 23 LANGUAGES RE-STARTED FRM AN EU. COUNTRY; ASKS LISTENERS TO "TRY" the "OLD" FQS FROM TIME TO TIME (9,630, 11,825, 15,285 ARE LISTED by WRH60—Ed.)

SWITZERLAND — VERIFYING SPECIAL CHRISTMAS MASS xmsn hrd Dec. 24 last frn HER4, 9,535, Berne, in Eu. Serv., SBC said IS ANNUAL FEATURE (NOT always frn same church; this b/c was frn village of Grub nr St. Gall—German-language region—and b/c ORIGINATED OVER LOCAL XMTR AT BEROMUNSTER IN EASTERN SWITZERLAND, NOT FAR FROM AUSTRIAN BORDER). (Boice, Conn., Roemer, Ky.)

TAHITI—R. Tahiti, 6,135, Papeete, noted w-excellent sig 0700-0730 w-man-woman in Fr. (KBLP)

TAIWAN (FORMOSA)—BCC, Taipei, NOW radiates its TWO ENG. sessions 0130-0145 (to N. Am.), 1005-1050 (to Asia) on 7,234, 11,815, 15,345, 17,755. (Buettner, Germany, via WRHB; Ferguson, N.C., Balbi, Calif., others) Hrd on 15,345 w-ENG. 0133 tune-in to N. Am., weak, "fluttery." (Whitaker, Ind.) Hrd s-on 1320 w-"Little Dragon Show" (ENG.), w-strg QRM frn Peking, 7,230, to the 7,234 outlet; 11,815 fair; 15,345 weak; 9,575 IS NOT USED AT ALL NOW. (Balbi, Calif.) BED44, 3,967, Taipei, hrd 1519-1600A in Chinese in H. Serv., NOT JAMMED! (Palmer, Wash. State)

TANGANYIKA—FB cd rcd frn Dar-es-Salaam, 5,050; LISTED POWER of 20 kW, antenna as folded dipole. (Roth, Conn.) QRA is P. O. Box 1649; closes 2000. (ISWC) Hrd w-E-N 0425-0440A, then w-WX rpt; man annr. (Niblack, Ind.) Observed in Wash. State 1516-1535 in Swahili w-native mx to 1530, then went into "rock-an-roll" mx; several ads hrd. (Palmer) Hrd ALWAYS STRG in Sweden on 4,785 (PROBABLY REPLACED 4,845 which IS NO LONGER HRD) at 1630-2030 s-off. (Lindberg via GDX)

THAILAND—Thai National Broadcasting Stn, 15,387, Bangkok, has ENG. frn 1025-1130; hrd in Sweden. (Bjernstad via DX-Radio, SRK)

TOGO (Fr.)—R. Lome, 5,045, often hrd opening 1729A w-call in vernaculars, then w-native songs for about 1 hr; at 2000 features Fr. mx prgm. Often gud to 2200 c-d. (Magnusson, Sweden, via GDX)

TUNISIA—R. Tunisia noted on NEW fq 9,630 s-on 0500 to 0815, and 1600-1900 (when is "clobbered" by WDSI on NEW channel where WDSI runs to 0630). (Balbi, Calif.) Hrd in Dela. 1820

w-Ar. chants, ID by man in Ar. 1930, talks or news in Ar. 1835; vy nice sig, and "splashes" Luanda, 9.629, Angola, out of the picture! (Cox) O.K. in Texas 0500 s-on. (Stark) Observed in N.Z. 0800 when ID AFTER ACCORDION VERSION OF "Beer Barrel Polka"; blotted out 0825 by R. Canada in S. Pacific xmsn; All-Ar. in 1st xmsn, BUT DID NOT Fr. 1700, ENG. 1800. (Cushen)

TURKEY—R. Ankara, 9.745, noted opening 0500 in lingo (TRY ON TUE. GHT when HCJB, Quito, Ecuador, s-off 0430). (Stark, Texas) Hrd over TAT, 9.515, w-IS 2227 and s-on 2230 in Sp. w-considerable QRM. (Ferguson, N.C.) Technical University Radio, 6.250, Istanbul, hrd in Sweden 1955-2005 c-d; SINPO 44544. (Lindberg via GDX)

UNIDENTIFIED—Fr. spkr hrd closing 2200 on 4.775, suspected may be Libreville, GABON, MOVED from 5.025; used "L. M."; could NOT locate Gabon on 5.025. Fr. spkr hrd on 4.897 to 2100 s-off (SAT. 2200) "may" be projected "R. Congo" at Brazzaville, CONGO REP., but since does NOT use "L. M." at c-d, it "may" instead by a BELGIAN CONGO outlet; prgms mostly Af-type mx, usually w-woman anncr. (Cox, Dela.) Stn noted on 4.900 arnd 1500 w-typical S. Asian prgm; audio quality vy POOR. Could be Ceylon (?). Stn strongly suspected as R. Sarawak, Kuching, SARAWAK, hrd on 4.835 to 1400 s-off; uses "short" version of "GSTQ" at c-d. Ar. spkr hrd on 11.855 frn arnd 1545 to PAST 1630 is BELIEVED to be R. Omdurman, SUDAN; WRH60 says Omdurman uses 11.855 in Ar. 1430-2130, w-break for ENG. 1600-1630, BUT NO ENG. WAS HRD THEN. (Palmer, Wash. State, via URDXC) A "mysterious" Belgian Congo stn has been hrd often on 4.880 w-call and nx in Fr. 1815 DAILY; seems to be a R. Congo Belge outlet for Ruanda-Urundi and MAY be located in Leopoldville(;). (Lindberg, Sweden, via GDX) What APPEARS to be a CLANDESTINE CUBAN noted on 9.818AV on several checks arnd 0230; long, impassioned speeches in Sp. and "Habana," "Santiago," and OTHER CUBAN CITIES are mentioned; woman sometimes "chimes in"—and stn occasionally "falls" off the air for short periods; NO ID OR SLOGAN HRD EVER! (Niblack, Ind.)

UNION OF S. AF.—SABC, 7.229, Paradys, hrd in Wash. State 1640-1658 when COMPLETELY FADES OUT w-prgms in ENG., news to 1648. (Palmer) Hrd on 25.800 w-orgn mx 1605; ID 1700 for "SABC." (Howald, Calif.)

UPPER VOLTA—R. Ougadougou, 4.815, now hrd AS EARLY AS 1730 w-QSA 3 BUT w-interference. (Johansson, Sweden, via GDX) Also noted OFTEN OF LATE arnd 2000. (Elfving, Sweden)

USA—FLASH!—In a Hearing Case, the FCC anncd on Feb. 10: "Commission granted application of Albert L. Carin and S. Lee Braxton, doing business as GLOBAL BROADCASTING CO., 2663 Spring Vale Lane, DALLAS, TEXAS, for NEW INTERNATIONAL BROADCASTING STATION on 15.180, 50 kW-DAYLIGHT, to BEAM PRGMS TO BRITISH GUIANA, COLOMBIA, ECUADOR, VENEZUELA, SURINAM, PERU, and PARTS OF BOLIVIA and BRAZIL. This is the FOURTH current international broadcasting grant by the Commission. WORLD WIDE BROADCASTING SYSTEM, INC. and KGEI, INC., operate such stations at Scituate Mass.

(WRUL) and Belmont, Calif. (KGEI), respectively, and the CROSLY BROADCASTING CORPORATION operates an EXPERIMENTAL international station (KQ2XAU) at Cincinnati, Ohio. Together they operate 6 transmitters. However, the U.S. INFORMATION AGENCY operates about 42 transmitters in the U.S. in connection with the "Voice of America" programs." (NNRC)

F L A S H !—WRUL, New York City (w-xmtrs at Scituate, Mass.), is in the PROCESS of having its control TRANSFERRED from WORLD WIDE BROADCASTING SYSTEM to METROPOLITAN BROADCASTING SYSTEMS, INC. Programming will possibly change when the transfer is official. KGEI, Belmont, Calif., IS ALSO IN THE PROCESS OF BEING TRANSFERRED from KGEI, INC., to the FAR EAST BROADCASTING COMPANY, INC.; KGEI would be used as a PART of the "Call of the Orient" IF the transfer is approved by the FCC. FEBC, with main xmtrs at Manila, THE PHILIPPINES, has all-religious programming. (NNRC) THE ORGANIZATION OF AMERICAN STATES (OAS) has b/c in Sp. to L. Am. 0000-0300 to E. S. Am. on 15.270, 17.740, and to W. S. Am. over 15.250, 17.710. (WRHB) (Uses VOA facilities—Ed.)

USSR—"DX-CLUB" is R. Moscow's NEW DX SESSION, skd SECOND and THIRD MON. EACH MONTH 0050, 0350 in N. Am. Serv. (ECNA) and 0415 in WCNA Serv. (AMSWLC) R. Moscow, 9.745, noted recently in ENG. 0110 w-"Russian by Radio"; NON-STOP DANCE MX, MULTI-LINGUAL ANNCMTS, including ENG., then entirely dissimilar IS from one usually associated w-R. Moscow! (Niblack, Ind.) R. Tashkent, 11.690, hrd in ENG. DAILY 1200-1230 w-news, "COMMIE-taries," and a LITTLE MX! (Boice, Conn., others) H. Serv. of R. Tashkent, 6.825, ud sig thru CWQRM 0205, woman in Russian nx; Komsomolsk, 15.235, RELAYING Moscow, beamed on WCNA, good level 0305 in E-N by man. (Cox, Dela.) R. Erivan, 7.270, Armenian S.S.R., POWERFUL LEVEL DAILY in N. East, opens 1400 in Ar., ID as "Huna Erivan." (DXHCNE) Novosibirsk, 4.450A, Central Asia, RW281, hrd 1416-1423 in Russian; weak, noisy. (Palmer, Wash. State) Kazan, 4.055 (LISTED 5.050 in WRH60), hrd SOME DAYS to s-off 2200A in native, weaker lately. (Cox) R. Alma Ata now radiates prgms in Ger. (for Germans in Kasakh S.S.R.) 1325-1400 WKDAYS ONLY, 9.380, 10.530. (JAPER, Germany, via WRHB)

VATICAN—HVJ, 9.646, hrd SUN. w-MASS 0830-0945 parallel 11.685 (this one hrd well in W. Va.—KBLP); also 0730 (JAMMED!). (Balbi, Calif.)

VIETNAM (N.—Democratic Rep.)—R. Hanoi's F. Serv. outlet, 11.840, noted 1220 w-native-type mx; 1230 short "march" (quite similar to R. Peking's), then w-DEFINITE ID: "Ici la Voix du Vietnam, Ici la Voix du Vietnam," by woman; cont'd in Fr.; abt S7. (Niblack, Ind.) R. Hanoi, 9.940, hrd 0515 in lingo. (Howald, Calif.)

VIETNAM (S.—Rep.)—VTVN, 9.754, Saigon, hrd 1440-1500; JAMMING QRM. (Magnusson, Sweden, via GDX). S-off NOW is 1500 (formerly 1600) on 9.625, 9.754, 6.165, 6.115; LATTER IN-AUDIBLE DUE USSR STRG ON 6.115 to 1500 s-off in H. Serv. (Balbi, Calif., others)

(continued on inside back cover)

SHORTWAVE PROFILE



Mr. Sidney Pearce
Berkhamsted, Herts., England

One of the world's most noted SWLs . . . a DXer *par excellence* . . . a wide contributor to DX broadcasts, radio club house organs, journals, and magazines all over the world . . . and one of my best friends for many years . . . is Sidney Pearce, St. Malo, 23, Charles St., Berkhamsted, Herts., England. Sid began SWBC DXing back in January 1936, following a visit to the Wireless Exhibition in London in 1935, where he saw a kit of parts for a three-valve (3-tube) shortwave, battery-operated receiver.

They also were issuing a book on shortwave listening, how to operate the shortwave receiver when built, and what stations you "should be able to hear" on given wavelengths.

You can guess the rest! Sid bought the kit "for Christmas" 1935, put it together—and the first station he logged was W3XAL, Bound Brook, New Jersey, USA, carrying a sponsored program.

In October 1938, Sid purchased a HALLICRAFTERS "Sky Champion" communications receiver which he still uses—with a few modifications, such as a trimmer on the outside instead of at the bottom of the receiver. And he now uses a "Q'Fiver" attachment which can be "switched in or out to give the selectivity that is so necessary these days!" Sid comments.

This world-renowned and highly successful SWBC DXer considers his aerial system as "poor"—it consists of a single wire running up to and around a "loft"; however, Sid does live on a hill overlooking the town and is located in "open" country.

While Sid has not kept a count of the veries in his collection, they run well into the thou-



A world-renowned SWL and contributor to radio DX broadcasts, club bulletins, and magazines. Sidney Pearce of England has been a SWBC DXer since 1936. Sid still uses the HALLICRAFTERS "Sky Champion" shown here, which he purchased in 1938. He now uses a "Q'Fiver" attachment "to give the selectivity that is necessary these days!" he comments. Sid has collected literally thousands of QSLs from the four corners of the earth.

sands! He has verified 160 countries—all SWBC.

Sid has logged so many "catches" that he is reluctant to point out one as his "best." However, he admits that a mighty good one was back in 1939 when he verified FK8AA, Radio Noumea, New Caledonia, when it was running only 50 watts! "You couldn't catch it nowadays with all those high-powered transmitters operating every few kilocycles!" he cites. Sid also has Radio Noumea's present QSL card.

"Other pre-war QSLs whose loggings and verifications gave me quite a thrill include XMHA, 11.910, Shanghai, China, a Commercial American Station there in 1939; VPD2 and VPD, Suva, Fiji Islands, operated by Amalgamated Wireless (Australia) Ltd., 1936; YI5KG, Baghdad, Iraq, 7.140 and 9.683, whose owner was Prince Faisal of Iraq (now King of that Near Eastern nation), verified in 1938; all transmitters were American.

"Some of my 'best' post-war veries are those of ZBW, Hong Kong, 1958; R.O.N.G., Biak, Dutch New Guinea; Radio Sabah, Jesselton, (British) North Borneo.

Once they have verified a station or a country, many SWLs never send a "follow-up" report—but not Sid Pearce! Sid sends "follow-up" reports quite often to the stations—in fact, his name is a by-word among SWBC station engineers around the world—and his valuable reception reports have rewarded him with literally thousands of QSLs from all over the globe!—KEN BOORD

RADIO AUSTRALIA

(continued from page 9)

Radio Australia now broadcasts more than 43 hours of programs a day—37½ hours for listeners in South, Southeast Asia, and the Pacific Islands. This includes 3½ hours in Indonesian, 2 hours in Mandarin Chinese, and 1 hour each in Thai and French. Other services are being planned.

Commentaries on Australian and international issues provide a background to Radio Australia's news sessions.

Talks range from Australian geography and history, industrial development, scientific research, education, and standard of living to the ideals of the British Commonwealth of Nations, the life of the aborigines, and the Australian attitude on world affairs. Overseas listeners are keenly interested in Radio Australia's sporting programs, especially interviews.

Programs are designed to suit the requirements of the various target areas. For example, in broadcasts to America, Britain, Europe, and Africa, the spoken word predominates, since *people in those countries listen to Radio Australia for information rather than for entertainment*. In many parts of Southeast Asia and the Pacific Islands, however, Radio Australia supplements and sometimes replaces local stations for normal day-to-day listening, mostly in the form of music, using as many Australian artists and composers as possible. There are quite a few relays of Home Service programs, such as concerts, variety shows, plays, and the weekly "Guest of Honor" talks.

Australia's Overseas Broadcasting Service was established in December 1939, as a wartime measure. As the broadcasting division of the Department of Information, its headquarters was in Melbourne.

The actual broadcasting was done from the studios of the ABC in Sydney, New South Wales. The Postmaster General's Department was responsible for the technical side of its operation. Towards the end of 1940, all operations were concentrated in Melbourne, Victoria.

The first transmissions were directed to the British Isles, Europe, North America, South America, and countries in Asia and the Pacific. The first languages used were English, French, German, Spanish, Italian, and Dutch.

The two main purposes of the Service were to present the Allied case as seen in Australia, and to send news of home to the Australian troops in the Middle East. There was early evidence—mainly from correspondents—that the independent presentation of Allied views by one of the British Dominions carried weight—especially in America. Despite the low power of the transmitters (one of 10 kW and two of 2 kW), the programs reached Southeast Asia and the Pacific Islands more clearly than those of any other Allied country, due to Australia's most favorable geographical situation.

When the Japanese entered the war, attention shifted more definitely to the Southeast Asian and Pacific Areas. The European languages were dropped—except for French and Dutch—and, early in 1942, programs were established in Indonesian, Thai, Chinese, and Japanese.

VK2ME "THE VOICE OF AUSTRALIA"

Power—10 to 20 Kilowatts
Wave-Length—31.25 Meters



The laughing notes of the Kookaburra open and close the A.S.A. World-wide Broadcasting Service.

AMALGAMATED WIRELESS (A/SIA) LTD.
AUSTRALIA'S NATIONAL WIRELESS ORGANISATION



A. W. A.

Owns and Operates

Beam Wireless Services to Great Britain, The Continent of Europe and North and South America.

Wireless Telephone Services to Great Britain, The Continent of Europe, North and South America, Java and New Zealand.

Coastal Radio Stations in Australia, France, New Guinea and Fiji.

Wireless Services on ships of the Australian Mercantile Marine.

Radio-Electric Works for the manufacture of every type of transmitting equipment and Radiotele broadcast receivers.

Research and experimental laboratories.

World-Wide Broadcasting Service

RADIO AUSTRALIA

OVERSEAS SERVICE AUSTRALIAN BROADCASTING COMMISSION

P.O. BOX 428 G
MELBOURNE



OFFICIAL VERIFICATION

18 AUGUST 1961 BALBI, LOS ANGELES

This confirms your reception of VK2ME, operating on 31.25 M.

reception on 31.25 M. 20000-70

We thank you for your reception report.

TRANSMISSION DIRECTED TO S. E. ASIA.

AUSTRALIA QSLs—THEN AND NOW!—The QSL at left pre-dates Radio Australia and was received by your SW Editor, Ken Boord, for his reception of March 5, 1934, from VK2ME, "The Voice of Australia," 31.28 m. (9.590), Sydney, N.S.W., operated by Amalgamated Wireless (A/SIA) Ltd., with "beam Wireless Services to Great Britain, The continent of Europe, and North and South America." Ken logged this one on a 4-tube regenerative rx that employed plug-in coils. Contrast this QSL with that at right for Radio Australia's VERY LATEST (NEW) transmitter, VLY25, as logged by August Balbi, Los Angeles, Calif., at 0000 GMT on Jan. 31, 1960, in transmission directed to S. E. Asia over this EXPERIMENTAL station.

The aim of the broadcasts was to inform the people of the occupied countries of Allied preparations to strike back at the Japanese, and to encourage resistance to the enemy. Enemy propaganda was examined and answered and great care was taken to give factual, objective news and sober comment on the course of the war.

This policy, which gained listeners' confidence in the days of adversity, was particularly effective as the counter-attacks against the Japanese gained strength.

Since the war, Radio Australia—as it came to be called towards the end of 1945—has presented a picture of Australian life and thought, has promoted goodwill, and has encouraged trade with overseas countries.

The Postmaster-General's Department is responsible for the technical service of Radio Australia and for the provision and maintenance of its transmitters. The VLA and VLB transmitters, designed and constructed in Australia during the war, are each capable of radiating 100 kW of RF power. VLC is a 50-kW RCA transmitter imported from the United States in 1942. A 50-kW RCA transmitter, VLD, was brought into service in November 1956.

VLY, a new 10-kW Australian-built transmitter, now operates "experimentally" in the 11-meter band, 25.735, directed to Asia between 2214½ and 1400 GMT.

The site of the transmitters is at Shepparton, 120 miles north of Melbourne, in the fertile fruit-growing district of the Goulburn Valley. Programs are fed over program lines from Melbourne equalized to 10 kc and, in addition, two studios have been provided within the attractive transmitter building for use in event of interruption to the program lines. Each transmitter can operate on any channel in the frequency bands allocated to the various countries by international broadcasting authorities—i.e., they are capable of operations on any of the number of channels from 6 to 22 mc.

The equipment used to switch the transmitters to the various antennas is operated by remote control. An antenna-switching desk is provided in the transmitter room for each transmitter. These desks are equipped with a number of press keys and indicating lamps so that when it is necessary to change a transmitter from one antenna to another, the operator presses the appropriate keys. The switches themselves, which are located out in the open, are motor-driven, and the indicating lamps



This jovial gentleman—Keith Glover—answers the mail each week in Radio Australia's "Mailbag" session which can be heard to ECNA on SUN. 1230 over VLB11, 11.710, and to WCNA on SUN. 1600 over VLB11, 11.810. Letters to Radio Australia from overseas listeners now total more than 1,000 a month.

on the antenna-switching desks show that the switching operation has been completed and that the required connection has been made.

The antennas are half-wave stacked arrays with reflectors. Those on the European and American beams are reversible and slewable, while those on the North Pacific beam are non-reversible. The arrays are supported on steel towers 210 feet high, 14 such towers being required to provide the requisite number of antennas. The gain on these arrays varies from 10 to about 16 db., according to frequency. Each of the 19 antenna arrays is connected by radio frequency transmission lines to outdoor automatic-switching centers.

A second 10-kW transmitter used for the Overseas Service is VLG, located at Lyndhurst, 24 miles southeast of Melbourne.

As we bid a fond—and temporary—farewell to Radio Australia, I'd like to summarize by quoting this well-put phrase from a recent issue of the Australian newspaper, the HARBOR TRUST:

"As Radio Australia grows, so does this nation's prestige. The programs going out from Victoria are an important link in the chain of better understanding in an ever-narrowing world."—KEN BOORD

AT FADE-OUT

FLASH — "MOONECLIPSE" REPORT — On March 13, George Cox, Dela., followed the moon eclipse through its "entire show"—beginning in Dela. 0745 GMT, lasting to 0915 GMT. He reports to DXH: "I wanted to see if it would have any unusual effect on reception—especially on the lower frequencies. However, NOTHING OUT OF THE ORDINARY WAS NOTED. Sierra Leone, 3,316, had a very good signal 0700, and MW KFI, 640 kc, Los Angeles, Calif., was "LIKE A LOCAL" 0700; Petropavlovsk, USSR (whose area was affected by the eclipse) was at its USUAL AVERAGE LEVEL on 5.050 at 0900." (Many thanks, George! —Ed.)

FLASH!—SUNSPOT COUNT FOR FEBRUARY 1960 as heard by GRADY C. FERGUSON, N.C., from HEU3, 9.665, Berne, SWITZERLAND, March 4, 1855 GMT—FEBRUARY—1-173, 2-191, 3-184, 4-152, 5-142, 6-145, 7-123, 8-116, 9-143, 10-143, 11-115, 12-116, 13-97, 14-114, 15-94, 16-84, 17-73, 18-60, 19-50, 20-49, 21-46, 22-50, 23-56, 24-74, 25-80, 26-82, 27-89, 28-82, 29-78. FEB. AV.—103.5. PREDICTED—MARCH 118; APRIL 114; MAY 110; JUNE 106; JULY 102; AUGUST 98. DEFINITIVE MEAN NUMBERS FOR 1959 — JAN. 217.4; FEB. 143.1; MARCH 185.7; APRIL 163.3; MAY 172.0; JUNE 168.7; JULY 149.6; AUGUST 199.6; SEPT. 145.2; OCT. 111.4; NOV. 124.0; DEC. 125.0; 159 AV.—159.0.

AFGHANISTAN—Still note R. Kabul, 9.705A, w-Eng. to 1930; N-E 1905, commentary 1918. (Pearce) Veri for rpt of TEST b/c on 9.573 LISTS POWER as 50 kW; rpt sent airmail Jan. 16, OSL back by registered mail Feb. 29. Is "true" veri! (Roth, Conn.) **ALBANIA**—Cox, Dela, confirms Tirana now has Fr. 2200 on 7.157M; 2210 noted w-Fr. nx by woman anncr; 2245-2257 s-off in ENG. **BARBADOS**—VPO, Barbados Radio, hrd w-fair sig fr 2400-0500 on 2.185 w-traffic; same time, same fq, can hear VSI, TURKS IS. RADIO, w-vy gud sig. (Cooper, S.C.) **BELGIAN CONGO**—OTH, 9.210, Leopoldville, hrd w-warm-up 0355 (beating of sticks or bones); s-on 0400 w-"rooster song," then ID for "R.C.B.," followed by native-type mx, nx; gong at IS. (Rowell, Minn; White, Ont., Canada) R. Coquilhatville, 5.992, hrd frm 0500 w-man, woman in Fr., native-type mx; weak but clear. (Cox, Dela.) **BRT. HONDURAS**—BHBS, 3.300, when s-off 0220, asks for rpts; anncs in dual on 1,280 kc MW. (Cooper, S.C.) **BURMA**—FLASH!—BBS, 7.015, strg but w-some QRM on NEW SKED for E-N 1430-1445 s-off; weak stn underneath could be R. Malaya, VUNC strg in lang. (Balbi, Calif.) **CAMEROON (FR.)**—R. Yaounde, 4.975, fair in Fr., YL, man anncrs w-nx, ID 0645. R. Garoua, 5.010, fair w-mx, nx in Fr. 0606. (Howald, Calif.) **CANADA**—CKFX, 6.080, Vancouver, B.C., hrd w-local nx 0630; power LISTED 0.01 kW. (Howald, Calif.) **CLANDESTINE**—FLASH!—Sp-spkng CLANDESTINE stn on 6.088, widely rptd, is BELIEVED LOCATED IN DOMINICAN REP.; on a SUN. tuned 2145 w-L. Am. instru mx at excellent str to 2215, when anncd: "Attention! Attention! Radio Liberacion de Venezuela" (REPEATED TWICE); no location given, BUT SINCE NO VENEZUELA OUTLET WAS COMING THRU THEN (BEFORE

SUNET) ON 6 MC AND THE DOMINICAN STATION ("LA VOZ DOMINICANA") ON 5.970 WAS HRD AT ONLY SLIGHTLY WEAKER LEVEL, it seems quite likely that LOCATION IS ACTUALLY IN D. R., rpts West, N.J. "Radio Free and Fighting Algeria" is BELIEVED to be Ar.-spkr noted on 8.024 2100 w-chants, talks in Ar.; gud level but smeared by CW; same time, R. Beirut, LEBANON (NOT a Clandestine!—Ed.), was noted on 8.006, and the Clandestine "Algerian Renaissance" outlet was hrd on 8.220. (Cox, Dela.) **CUBA**—R. Oriente, 6.307, Santiago, strg w-L. Am. mx, anncmts in Sp, 0400; CWQRM. (White, Ont., Canada) **DOMINICAN REP.**—HI8Z, R. Santiago, has MOVED frm 6.085 to 6.310. (Legge, Va., via WRHB) **DUTCH NEW GUINEA**—NEW sked SAT. 2100-2200, 6.074AV; SUN. 2330-0430, 9.745 and 5.040; also DAILY 0900-1330, 6.074AV and 3.735. (RADX; Tabuchi, Japan, others) Balbi flashes frm Calif. that dictation-speed N-E on 11.670 is now hrd ONE HR LATER—0630-0700. **GABON**—R. Gabon, Libreville, hrd on NEW 4.775; c-d SAT., SUN. 2200; veries by cd. (Hedstrom, Sweden, via SCDXers) **GUINEA REP.**—Contrary to WRH60, Conakry does NOT s-on 0700, nor does it s-off 2130 wkdays; hrd in PROGRESS w-chants in Ar. 0645, and s-off 2100; "BEST BET" for this one is 0700 when sig peaks. Fq is 4.910. (Berg, Conn.) **HAITI**—THURSDAY is still "SILENT DAY" at 4VEC, 6.002, 4VWI, 9.773, Cap Haitien. (Stark, Texas) **FLASH!**—In mid-March 4VEH was RESUMING WORK ON NEW ANTENNA after delay caused by around 11 inches of rainfall "lately" which held up the work temporarily. (Saylor, Va.) **HOLLAND**—Many rpts confirm R. Nederland has "dropped" 9.590 (REPLACED by 11.755) parallel 6.020 to N. Am. both wkdays, SUN. (Edgar, Pa., others) SUN. "HAPPY STATION PROGRAM" hrd on 15.220, good level in Mo. arnd 2130. (Udpike, Mo.) **INDIA**—AIR, 9.550, Bombay, hrd DAILY 1430-1600, native mx, Hindi; Madras, 9.590, noted occasionally 1530-1630 w-similar format. (Rowell, Minn.) **FLASH!**—AIR, 11.710, hrd w-ENG. 0045-0145 DAILY; anncd to UK on 11.710, 9.590, and to W. Af. on 15.105, 17.795 AND ON EXPERIMENTAL 15.195. (Boice, Conn.) **JAPAN**—FLASH!—At press time, from Balbi, Calif., comes word that R. Japan's beam to WCNA 0500-0700 is NOW on 17.825, 15.325, AND 11.705; and that Tokyo anncd that frm April 1 WILL have SCANDINAVIAN HOUR IN DANISH, SWEDISH, FINNISH in 2nd EUROPEAN beam—1900-2100 on 15.325, 11.705, AND 9.525; also, from April 1, S. Asia beam will be on 11.965, REPLACING 9.525, parallel 15.325 at 1500-1630; the beam to Australia will be on 15.325, REPLACING 11.940, parallel 11.800. From RIGA, LATVIA, USSR, an electronics engineer who is a monitor for DXH, says R. Japan "was discovered" in March for first time since summer 1958; was hrd almost DAILY in March 1960 on 9.675 at 2000, and since has been noted w-ENG. 1740-1830, 2050; last time R. Japan was audible in Riga was summer 1958 over JOB24, 21620, 0630-0830. Frm April 1, sked for R. Japan WILL BE ALTERED to include SEVEN XMSNS of its DX PROGRAM details promised by JSWC. **KOREA (NORTH)**—R. Pyongyang, Korean Central Broadcasting Station, has ENG. MON., FRI. and ESPERANTO WED. 1100-1130 on 6.250, also on

(continued on page 36)

"THE MYSTERIOUS E SKIP"

(continued from page 11)

layer the ability to reflect (refract, or bounce) electromagnetic signals (including VHF television signals).

What this catalyst is, or why it chooses to act when it does, remains a mystery. It is unpredictable, and apparently, as of yet, uncontrollable.

Some researchers believe the catalyst comes from below (the troposphere or stratosphere), while others believe it comes from the sun in the form of an unknown radiation. Still others believe the catalyst is in the layer to start with.

OBSERVATIONS PROVE HELPFUL

Television DXers have been observing the effects of E Skip for more than a decade. Many thousands of man hours have been spent compiling reports, gathering data, and (then finally) analyzing the data; in hopes some patterns could be found in the random occurrences of E Skip. *And many patterns have been found.* Some patterns last only days, others last weeks, while some are yearly in cycle. All are important. Chart Number Two shows the relative number of E Skip reports received by the *Radio Electronics* TV DX column from June 1955 through December '59. The percentage breakdown clearly shows that over a 4.5 year period, a long term trend favors E Skip as a summertime occurrence. This is why May 1 through September 1 is referred to as *the E Skip season*. The number of reported E Skip openings increases markedly during these months. In fact this trend has been blamed for "fair weather TV DXers" who DX only during the summer, and seldom touch the dials during the other periods of the year when other types of DX are abundant.

MAKING USE OF KNOWN DATA

We also know certain years are better for E Skip than others. Strangely enough, a good winter session (in January) is usually a tip off an above average summer session (May through September) will follow. The years 1954, 1955 and 1959 were considered good E Skip years. And 1958 was a very poor year by these standards. 1956 and 1957 were good in spots. 1955 was perhaps the best known to TV DXers.

The winter of 1955 was very hot in most portions, and it was followed by a good sum-

mer. The winter of 1958 was not so good, and the summer skip season in '58 was short lived and not strong (few openings above Channel 4). This past winter season has been considered somewhat above average, although *not highly unusual*.

It is unlikely then the winter season for E Skip (often referred to as the minor E Skip peak), is associated with the summer preceding, but more likely, with the summer that follows. Like the changing of the calendar, the coming of spring brings a new E Skip season.

MECHANICS OF E SKIP

Ionization (the forming of reflective areas) in the E layer occurs in patches, or spots. The ionized patch may be but a few miles across (explaining the highly localized affects of E Skip, causing DX reception only in small areas, except in the best openings). And for reception, the spot is usually at the midway point, between the transmitter and the receiver. And it may be at any height within the 60-120 mile region of the E layer, but it is most likely to be between 100 and 110 miles up. *It is the height of this patch that determines the maximum distance to be covered by a single hop (or bounce). This distance is normally around 1500 miles.* Because of high altitude winds, the ionized patch often moves about in the E layer, explaining the fading of one station and the sudden appearance of another station from the same general region, on the same channel. By plotting this "swinging" movement of the stations received, a DXer can predict what stations should next be received.

E SKIP MECHANICS (Propagation Guide)

Type of Reception—*Rebounding from a rarified layer in the ionosphere.*

Channels Affected—*Television 2-6, FM band (88-108 megs).*

Channels Most Often Affected—*Television 2, 3 and 4.*

Signal Strength—*Varies from weak frame bars to several thousand microvolts.*

Hours of Reception—*Anytime day or night, most likely 0700-1000 LST, 1200-1400 LST, 1630-2200 LST (Local Standard Time).*

Distance Covered—*400 miles (rare) to 1500 miles (common), with "hop extension" to 2500 miles (rare).*

FM Reporting

Edited and Prepared by BRUCE ELVING
920 Laramie Street, Manhattan, Kansas

SKIP ON 88-108

The month of April means that the arrival of the summertime season for sporadic-E skip reception on FM is imminent. Summer skip has been noted in Duluth, Minn. by your editor as early as April 15, when in 1956, WGH-FM 97.3 Newport News, Va. was received. Normally, the season for FM skip reception is underway at least by late May.

Wintertime reception of FM skip is occasionally noted. For example, Richard Hermann, Franconia, N.H. received KIXL-FM Dallas, Texas and KOKH Oklahoma City shortly after becoming an FM DXer early this year. These are the only known instances of FM skip for the present winter. Excellent ground-wave reception has also been noted by Hermann, who seems to be ideally located at 1000' above sea level with an antenna up another 40 feet above ground. Within the last month, he reports receiving FM stations from Pennsylvania, Washington, D.C., Baltimore, Md. (including the 125-watt WBJC on 88.1), WBVA 105.9 Woodbridge, Va., WGH-FM Newport News, Va., and WCMC-FM 100.7 Wildwood, N.J. (with co-channel interference from WCOP-FM Boston and CBM-FM Montreal).

Also reporting FM skip reception is Wavne Baer, who heard KGNC-FM, 93.1, Amarillo, Texas in Meyersdale, Pa. on May 19, 1959. Baer has a Channel 6 five element yagi cut for the FM band.

The DX reception of W. Carroll Brooke, Jr., Blairstown, N.J. is plagued by the existence of more than 30 local signals. Despite this hindrance, Brooke received WWMT 95.7 New Orleans, La. last June. Using a 12-element Apparatus Development Company antenna and a mast-mounted Jerrold booster, Brooke has enjoyed ground-wave reception up to 250 miles—Richmond, Va., Boston, Mass., Pittsburgh, Pa. and Albany, N.Y.

MORE RECEPTION NOTED FOR JANUARY 30, 31 AND FEBRUARY 1

During the winter tropospheric opening in the Midwest at the end of January, Robert Boggs, who lives 20 miles southeast of Kansas City at Lee's Summit, Mo., received 15 Illinois stations, plus several from adjoining states. These included stations in Chicago, Peoria and Mt. Vernon, Ill.; KFH-FM Wichita, Kans.; and stations in Omaha, Neb. and Davenport, Iowa.

On Feb. 1, Hank Holbrook, Bethesda, Md., heard WSVS-FM Crewe, Va. through semi-local WJEJ-FM Hagerstown, Md. on 104.7 mc. Holbrook has an indoor Taco yagi antenna, and reports the reception of several Pennsylvania stations, the most distant of which is WWSW-FM 94.5 Pittsburgh. He also has the reception of the 10-watt KGTS 91.9 Takoma Park, Md. to his credit.

TEN-WATERS MAKE DXING NEWS

Speaking of reception of 10-watt educational FM stations, Eric G. Norberg, Carmel, Calif., offers as a followup to last month's discussion of those low-powered stations the comment that he "was surprised to find, in the March D-H, that reception

Tower and antenna of the former WFOW—Wisconsin's pioneer FM-only station in Madison. The 170-foot tower now supports the 8-bay antenna of the station—now known as WMFM—104.1 mc., with 7,500 watts at 100 feet above average terrain.

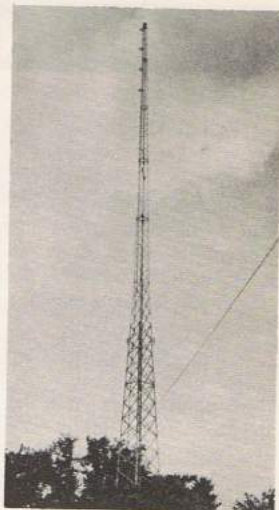

of 10-watt FM outlets beyond 15 miles is considered DX. I have been receiving KFJC, Mountain View, Calif. (88.5 mc.) regularly since its debut last Nov. 3, over a mountainous path of 60 airline miles. Signal (strength) varies from very poor to good (readable 80% of time), but is always there." Norberg uses a non-rotatable 10-element Taco FM antenna, and has heard every FM station between Sacramento and Modesto.

Another 10-watter, WXPB 88.9 Philadelphia, Pa. was heard at a distance of 70 miles by Walter G. Jung, Forest Hill, Md. He also received Philadelphia's WRTI 90.1 the same day—Feb. 25, 1960. With a 10-element, rotatable FM yagi antenna, Jung has heard stations as distant as New York (WKCR 89.9) and WAZL-FM Hazleton, Pa.

Another reporter with yagi FM equipment is Jimmie L. Mitchell, Princeton, Ky., who claims the ability to pick up from 30 to 50 FM stations any evening at distances up to 300 miles. Mitchell has a Winegard FMY8 antenna with a rotator, some 40 feet above the fairly flat ground. Since he has had the equipment only since Feb. 15, Mitchell is having difficulty in identifying all the stations "when most of them just give their calls every 30 minutes."

FM ACTIVITY IN WISCONSIN

FM station WFMR, 606 West Wisconsin Avenue, Milwaukee, Wis. will appreciate reception reports and promises 100% verifications, states David M. Novick, who is in charge of all verification letters from the station. With 26,000 watts on 96.5 mc., WFMR has program guide subscribers in northern Illinois and across the lake in Michigan. Novick himself has heard FM stations from as far as Indiana; however, most of his 45 stations have been from Illinois and Michigan.

Tom Mann, Milwaukee, Wis., states that WMIL-FM 95.7, that city, will begin programming April 20, 1960. WISN-FM should be on the air late this summer on 97.3 mc. WRJN-FM 100.7 Racine, Wis. was reported as being silent as of February, 1960.

Keep your FM reports coming. The deadline for the next issue of FM Reporting will be April 16 at Manhattan, Kansas.

PROPAGATION REVIEW

SHORTWAVE

The influence of sun spots upon the strange earth girdling properties of shortwave radio has been a subject of conjecture and vivid discussion since the mid 1920's. It is today, and it will be tomorrow (as a special "Sun Spot Report-60" will show, in the July DXH). Few scientists have ever debated the influence of sun and its spots however, *merely the hows, whys and wherefors.*

We suspect sun spots to be centers of magnetic activity on the sun's surface. Sun spots have polarity, and may be either positive or negative. Radiation from a sun spot is sent charging into space in the form of a stream of electrically charged particles. If such a stream is intercepted by our earth as we revolve about the sun, strange affects are noted on earth. The heavily charged "corpuseular particles from the sun" flow into our ionosphere and circle the earth at altitudes varying from 75 to 250 miles. This places these streams in our E, F1 and F2 layers of the ionosphere. Acting on the rarified air in the E, and F layers, the charged corpuseular particles set the normal F layer to vibrating, or oscillating, just as a gut string vibrates when "plucked." This rapid vibration causes rapid fading on shortwave signals propagated by the F2 layer (99 percent of all shortwave reception in the northern and southern latitudes). Further north, and south, near the poles, the flow of magnetically charged corpuseular particles forms a *rapidly revolving bowl* about the North (and South) Poles (magnetic poles). It is the greatly increased electrical energy from the sun, which has been intercepted by our earth and drawn towards the magnetic poles which causes the northern (or southern) sky to glow (aurora) on many nights of the year. And it is this same aurora, or flow of electrical particles towards the magnetic pole (where their natural attraction lies) which produces auroral reception on the VHF ranges (TV and FM) and causes either severe "aurora flutter" (rapidly varying degrees of signal strengths and "signal phase" on signals passing through the aurora zone between transmitter and receiver) or complete HF blackouts (above 12-20 megacycles). The degree of the electrical energy passing from the sun to the earth, and thence through the E and F layers can be measured

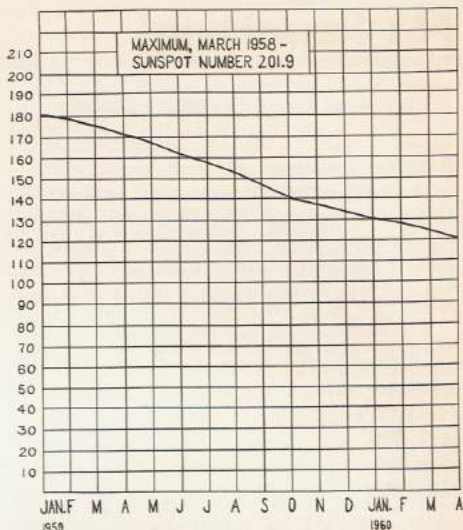

Declining Sun Spots — to April 1960

at least partially by the intensity of the fading, aurora flutter, or blackout present during a "magnetic storm." Near the equator, magnetic storms have a lesser affect on HF broadcasting, as the speed of the corpuseles, and their relative intensity within the F layer does not increase until they come within "striking distance" of the magnetic poles.

Not all sun spots eject magnetic energy however, for if they did the earth's ionosphere would indeed be a very unstable proposition. Like so many of nature's ways, one species builds up so another can tear down. In the case of sun spots, the great majority work as a "total accumulation" to build the F layer of the ionosphere into a good reflective device (see diagram page 7, this issue, F2 layer). It is only the occasional sun spot that comes along to throw out a stream of magnetic particles and disrupt the normal "building process of the ionosphere."

Sun spots run in several distinct cycles to be discussed, in part, in May. Very generally speaking, the peak of the cycle, with the *greatest number of sun spots present on the sun's surface, brings the best in shortwave HF broadcasting.* The current 11 year peak to peak cycle reached its pinnacle in March of 1958 when the sun spot count reached an all time record high of 201.9 (records have been kept since the 18th century). Currently, as the graph shows, we are on a downward trend

(continued on inside back cover)

FCC Analyzed

APRIL 19

Comments are due April 19 to FCC regarding its proposed plans of dropping in VHF channels in various midwestern and eastern areas where standard co-channel mileage separations are not met. One of the first cities to be affected is Grand Rapids, Michigan (WOOD-8, there now). Additional "V" for Grand Rapids would be gotten this way, says FCC (as opposed to the plan outlined here last month): trade Channel 6 for existing Channel 9 in Alpena, Michigan, trade Channel 7 for existing Channel 13 in Cadillac (WWTW on 13), trade Channel 9 for Channel 7 at Traverse City, and finally add Channel 13 (from Cadillac) to Grand Rapids. Simple, hey wot?

SHIFTS... OTHER DROP INS

It's formal now, WLUK (Marinette, Wisc.) 11, is not in Green Bay. Channel allocation changed by FCC.

Channel 7 has been proposed as a drop in at Prescott, Arizona by Radio KNOT there. No other changes necessary.

NEW UHFERS IN ALABAMA

Alabama State Educational TV net., growing like proverbial weed, has sought, and received a second set of reserved channels for a new second educational TV network for state. All of the new channels (7 in all) are UHF, and will probably be low power in design for coverage in specific areas. Nonetheless they should make very interesting DX targets.

Andalusia	New 29
Birmingham	New 48
Demopolis	New 18
Dothan	New 19
Florence	New 21
Munford	New 24
Tuscaloosa	New 24

GEORGIA NEWS

Channel 8 at Waycross, Georgia has been reaffirmed as an educational hold out. This after commercial applicant applied for the facility. A new Channel 9 in Savannah has been told it must tolerate interference from WTVM (9) Columbus, which may occur because of the 186 mileage separation between the two Channel 9 stations. WTVM is to move to 9 from its present UHF facility (28) while present WRBL (4) Columbus will move to Channel 3.

NEW FM STATIONS GRANTED, ON THE AIR

New On

KFAB-FM 99.9—Omaha, Nebraska
KHOL-FM 98.9—Kearny-Holdrege, Neb.
KCJC 98.1—Merriam, Kansas
WAQE-FM 101.9—Baltimore, Maryland
KJRG-FM 92.1—Newton, Kansas
KHIQ 105.1—Sacramento, California

Heard Testing

WPIT-FM 101.5—Pittsburgh, Pa.

CHANGES IN EQUIPMENT

WKOX-FM—Framingham, Mass., granted permission to multiplex with functional music.
WMRT-FM—104.7 Lansing, Michigan, change granted to 102.5, up power to 61.4 kW ERP.

NEW TELEVISION APPLICATIONS

Reno, Nevada 4—16 kW, antenna minus 362 feet.
Reno, Nevada 4—23 kW, antenna minus 303 feet.

GRANT REVOKED

Channel 10, Helena, Montana

NEW TRANSLATORS

Wheeler City, Texas—Channel 80, repeat KVII (7)

BACK ISSUES OF DXing HORIZONS AVAILABLE

Dozens of requests per week are pouring into DXH for copies of January (Vol. One, Number One) and February (Vol. One, Number Two). We have less than 100 saleable copies of these issues available, and will part with them for 50 cents apiece, or \$1.00 for both, postpaid. Address P. O. Box 3150, Modesto, California, ATTENTION: BACK COPIES.

FREE MAGAZINES... ANYPLACE IN THE WORLD!

Your publishing staff is so pleased with this issue of DXH we want every SW, TV and FM enthusiast in the world to have a copy! We know everyone who receives one will want to continue receiving this "new leader of the weak signal world." Send names and addresses of all the SWL's, TV and FM DXers you know of, or about, to "DXing Horizons, P. O. Box 3150, Modesto, California." We will mail each a copy.

AT FADE-OUT (continued from page 31)

MW. (Finkle, Taiwan, via SCDXers) KOREA (SOUTH)—FLASH!—HLK8, 15,410, Seoul, HAS REPLACED 15.225 frn 0530-0630, 0730-0830; badly QRM'd 0730-0830; ENG. first half-hour, then Korean. (Balbi, Calif.) LIBERIA—FLASH!—ELWA, Monrovia, hrd NOW on 21.525, NOT ON ANNC'D 21.515, in N. Am. weekly xmsns TUE. 2300-0045, parallel 15.200A, and WED. 0100-0245, parallel 11.986, (Balbi, Calif.) MONACO—R. Monte Carlo is now carrying SEVERAL OF THE RELIGIOUS B/C formerly radiated over "THE VOICE OF TANGIER (MOROCCO); NEW 100-kW stn is being built by RMC for this organization and name is being CHANGED FROM "VOICE OF TANGIER" to "TRANS-WORLD RADIO." (WRHB, others) MOROCCO—FLASH!—Radiodiffusion Marocaine, 7.225, so ID, strg at tune-in 0645; all-Fr.; ID 0700, then N-Fr. for 5 min; 0715 WORLD NX IN FR., also 0755-0800; Wn.-type mx featured; N-Sp. 0830; ID OFTEN AS "RADIODIFFUSION MAROCAINE." POWERFUL LEVEL in Calif.; MUST BE NEW HIGH-POWERED XMTR HRD IN TESTS OFTEN AND SO RPTD, but NEVER ID UNTIL MARCH! (Balbi) NIGERIA—FLASH!—NEW stn is Western Nigerian Radiovision Service, P. O. Box 1460, Ibadan. HAS NO CONNECTION w-NIGERIAN B/C CORP.; xmsrs were to begin operations in MARCH—wkdays 0530-2200 (SAT. 2230, SUN. 0630-2200) on 660 kc, 3.380, 6.050, 10 kW; all prgms to be ENG., and stn WILL VERIFY BY QSL-CD OR ITR. (DSWC, others) PHILIPPINES—FLASH!—DZF3, 15.385, REPLACED DZF2, 11.935 (where had moved recently frn 11.920); noted strg in Calif. 1430-1705 s-off; sometimes has QRM; E-N 1545; hrd on 17.805, 11.855, 9.730. POLAND—R. Warsaw noted on NEW 15.120 outlet to N. Am. w-E-N 0115, 0300, parallel 11.815, 7.315. (Balbi, Calif.) SARAWAK—R. Sarawak, Kuching, has REPLACED 5.037.5 by 4.835; hrd to 1100 in Chinese; 1100-1230 Iban; 1230-1400 Chinese. (Tabuchi, Japan, via JSWC; Balbi, Calif.) SAUDI ARABIA—Djeddah, 11.850A, s-on arnd 0430 (DURING RAMADAN SEASON 0505 AND LATER, ACCD TO HRS OF SUNSET); pre-s-on notes on flute, s-on w-band mx, Nat. Anth., then Ar. chant of "call to prayer." (Rowell, Minn.) SENEGAL—FLASH!—ENG. newscast 2230-2242V (MAY NOT BE DAILY) hrd in March frn R. Senegal, 4.893M, Dakar, and IS FROM OWN STUDIO, NOT A RELAY. (Cox, Dela.) SINGAPORE—FLASH!—What "appears" to be BBCFES, Singapore, noted on 25.750 now 1500-1630 s-off; all-lang; mentions "Pakistan" often so may be beamed there; ID 1545. (Balbi, Calif.) SOLOMON IS.—FLASH!—VQO2, 5.960, now s-on 0755; has local E-N to 0800 ID, on wkdays ONLY; SUN. s-on is 0900; suffers strg CWQRM. (Balbi, Calif.) TAIWAN—FLASH!—Balbi, Calif., flashes that BED53, 15.470A, LISTED 15.480, hrd strg w-religious prgm in Chinese 1600-1640 s-off; ID 1635 including for SEVERAL BEDS; first time hrd was in March; may have added power, OR could have been "freak" recptn. TANGANYIKA—Dar-es-Salaam, 5.050, noted 0415-0428 heavy QRM but ID certain, man anncr in ENG. (Saylor, Va.) TOGO (FR.)—Contrary to latest SORAFOM SKEDS FROM PARIS, R. Lome does NOT stay on to 2300 on SUN., but CLOSES 2200 after drum

IS on 5.047; also, no longer uses "L. M." at c-d. (Berg, Conn.) TUNIS—R. Tunis, 9.630, of late noted to 2158 w-gud sig; ltr frn stn said: "Our programs broadcast on SW-lengths of 9.630, and at 10 p.m. (local time?) on 9.790." (Roth, Conn.) DURING RAMADAN SEASON, hrd on 6.108A w-Ar. chants 2300, FINAL ANNCMT 0000, ID 0001, Anthem to 0003 close. (Berg, Conn.) UPPER VOLTA—R. Haute-Volta, Ouagadougou, 4.815, hrd frn 2123 tuning w-W. Af.-type mx; FINAL ID by man in Fr. 2131, few notes of mx, then "L. M."; weak but clear sig, EXCEPT for RTTY at times. (Cox, Dela.) USSR—R. Moscow has Russian Language Course on MON. 0110, 0410 on 11.890, 9.760 (possibly over other fqs?—Ed.) and WED. (to Pacific Coast) 0345 on 17.800 (in clear!). Textbooks are available from R. Moscow, Moscow, USSR. "DX Club" program is 0415 on SECOND SUN. of month 0050, 0350 on 11.890; also can be hrd 0050, 0350 on 11.890. (Mann, Wisc.) (Note: Sked for "DX Club" may be MON. GMT INSTEAD OF SUN.?—Ed.)

SPECIAL NOTICE TO ALL MONITORS FOR DXH!—Your FB cooperation is appreciated, but I must remind you that I can NOT enter into LENGTHY CORRESPONDENCE with anyone, and must RESPECTFULLY REQUEST that your reports BE CONFINED TO ONLY YOUR VERY TOP DX ITEMS—and PLEASE OBSERVE DEADLINES LISTED IN DXH. MANY REPORTS CAME IN TOO LATE FOR THE APRIL ISSUE! All my DXH work MUST BE DONE IN MY "SPARE" (?) TIME, which is quite limited, believe me! THANKS!—KEN BOORD

FB listening, EVERYONE . . . and 73!

—KEN BOORD

Unusually quiet ionospheric conditions persist, at press time (March 22.) Aurora sessions during early March were nil, and except for an unexpected barrage in April, quiet ionospheric condx, and good HF reception should continue. Predicted storm condx: April 8-9, May 5-6
Unsettled condx: April 2-4, 10-11, 29-30, May 7-8
Excellent SW condx: April 7, 12-14, May 4, 9-11

LAST MINUTE CUBAN IRRITATIONS

The Voice of America is considering renting the facilities of Florida and Puerto Rican AM BCB stations to answer Cuban Premier Fidel Castro's blasts at the USA. SPEAKING FROM AN EDITORIAL STANDPOINT, DXing HORIZONS ASKS THAT AMERICAN FCC OFFICIALS AND THE VOA PROCEED WITH EXTREME CAUTION HERE . . . as Castro might well use the broadcasts as an excuse to junk the Latin American Broadcasting Treaty, and start a little propaganda beaming of his own.

SW STATIONS NOTE

Ken Boord, DXH SW editor, asks that you forward to him a copy of regular program schedules, with changes as they are made, for his "World at a Twirl" column. Address SW Department, 948 Stewartstown Road, Morgantown, W. Va., USA.

SUBSCRIBE TODAY — AND HELP THE SW DEPARTMENT GROW!

PROPAGATION REVIEW

(continued from page 34)

destined to lower the sun spot number from the April 1960 estimated (current) mark of 121.5 to 5 to 10, during the winter of 1963. More generally speaking, HF broadcasting in the coming five years in the 11, 13, 16 and 19 meter bands will drop to an almost non-existent level at the low point of the cycle in 1963-65, when the higher frequency waves cease to be reflected from an almost non-existent ionospheric F2 layer. *This will mean complete shifting of virtually all SW broadcasting to the 25, 31, 41, 49 and 60 meter bands . . . or even greater "spectrum crowding" than we experience today, in 1960. More about this in coming months.*

Predictions for worldwide SW conditions (through May 15, 1960).

3.0-5.0 MEGACYCLES (60 meters and below)

Greatly increasing static level by the day with nighttime reception deteriorating in the northern hemisphere. Improved conditions from 2000 LST-0400 LST south of the equator.

5.0-8.0 MEGACYCLES (49, 41 meters)

Static levels increasing, poorer trans-equator reception for all North American observers. The 49 and 41 meter bands will be best from 0500 LST to sunrise when static and equator area "noise" are lowest.

9.0-12.0 MEGACYCLES (31, 25 meters)

The 31 meter band will have considerable low frequency noise (static crashes, rising hiss in receivers from 1800 LST to 0200 LST as equatorial area thunder storms, and general summer type weather in the tropics cause noise even into the Arctic regions. South of the equator, this is an excellent region for east-west paths from 0200-0700 LST. North of the equator, concentrate on reception from your east before 2200 (and after 1700) LST, and from your west just prior to sunrise locally.

15.0-18.0 MEGACYCLES (19, 16 meters)

For a few weeks, the 19 meter band will be the best for quality reception in the northern hemisphere. Good reception from all continents should be possible when the sun's rays are striking the midway point between you and the transmitter, during the afternoon hours, at the midway point. 16 meters will continue to be good between the South Pacific and most all areas, while South American reception, African reception, and European reception is already failing in North and Central America.

21.0-22.0 MEGACYCLES (13 meters)

Reception falling off above the equator, beginning to shine south of the equator. Reception reports on this band and the 11 meter band welcomed by all observers (P. O. Box 3150, Modesto, California, attention Propagation Dept.).

NOTICE:

Check last minute propagation predictions at bottom of page 36 for the up to the minute word on forecasted conditions.

THE WORLD AT A TWIRL

(continued from page 27)

WINDWARD IS.—IS used frequently by WIBS, St. George's, Grenada, 15.085, 5.1010, and other channels (at time) is a series of muffled notes played on a "local" steel-drum instru. (ISWC) When s-off 0215 annces return for "1200" which figures 1600 GMT. (Palmer, Wash. State) Among fqs recently used by WIBS for cricket matches b/c to UK recently were 21.680, 25.860. (GD/C, others)

CLUB NOTES—ENGLAND—We commend the ISWC, London, of which Arthur Bear is Hon. Secy., for its efforts to encourage SW stns to ID and to give fq and other pertinent information **OVER THE AIR OFTEN**—particularly at s-off. Incidentally, some of the really "big" organizations are the "leading" offenders!—Ed. . . . **JAPAN**—Due to illness, Yasuo Nagai has been succeeded by Kouji Yamada as DX Ed. of JSWC, according to a ltr to your SW Ed. from Kenro Wada; HQ QRA is Box 29, Sendai, Japan; Editorial Branch QRA is Box 1665, Tokyo Central, Japan. . . . **USA—AMERICAN SWL CLUB**, 46C Parkway Village, Cranford, New Jersey, USA, has just set annual dues at \$2; membership continues to grow! Maxey H. Irwin, Tenn., SW Ed. for AMSWLC, tells me that many new features are being planned for the club's house organ, and that some of them will be effected in the April "SWL" Bulletin. . . . **CONGRATS** go to a vy FB DXH cooperator, Alan Roth, Conn., who has just been named SWBC Ed. for the DX'er, house organ of the AUSTINTOWN (OHIO) SW CLUB. Editor is Paul Pormen, Jr., 5160 Mahoning Ave., Youngstown 9, Ohio. Issues house organ every other week throughout the year—each issue has news for SWLs and hams; also carries TV and AM b/c news. Membership cost is "just for the paper"—\$1 for 15 issues.

APPRECIATION—Thanks go to EACH OF YOU for your most splendid cooperation and help—SWLs, SW broadcasters, DX editors, radio clubs, and others around the world!

DEADLINE—Send YOUR BEST rnts for MAY DXH to Ken Boord, 948 Stewartstown Road, Morgantown, West Virginia, USA—to reach me BY APRIL 10. **DEADLINE for JUNE DXH** will be MAY 9. Thanks . . . gracias . . . merci! See you next month? . . . 73 . . . K. B.

WRH60 IS A "MUST" FOR SWLs

"A must" for EVERY SWL is the 1960 Edition of **WORLD RADIO HANDBOOK**, published by O. Lund Johansen, Lindorffsalle 1, Hellerup, Copenhagen, DENMARK. Available from agents all over the world—including **GILFER ASSOCIATES**, P. O. Box 239, Grand Central Station, New York 17, N.Y., in USA. Price is \$2.70 (postpaid); cost in other currencies is Da. Kr. 15.50, £ 0/15/6, DM 9.75, Sw. Kr. 12.50—**PLUS THESE POSTAGE COSTS**—Da. Kr. 1.20, £ 0/1/3, DM 0.70, Sw. Kr. 0.80. This "**MOST COMPLETE, ACCURATE, AND AUTHORITATIVE BROADCASTING AND TV GUIDE**" is **ESSENTIAL** as a year-around reference for SWLs, others. Contains a "wealth" of information on EACH station. —K. B.

Distribution Systems

Conversion Boosters

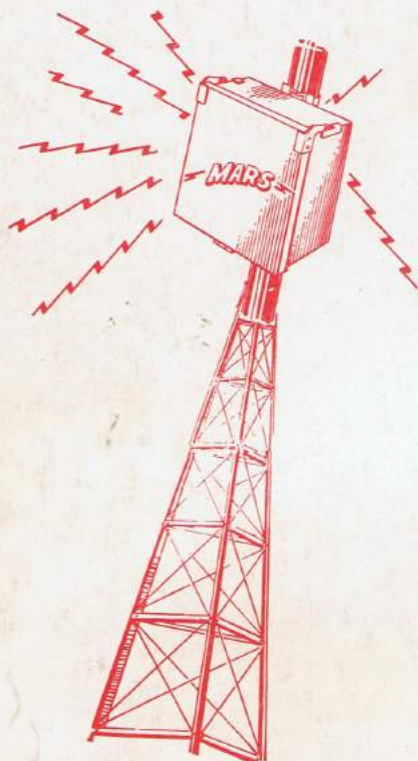

1. 10,000 Hour Reliability
2. First Quality Construction
3. Maintenance Free Operation
(All VHF Channels)
4. Wide Range Input and Output
5. Simple Installation
6. .005% Conversion Accuracy
7. Switching Circuit to Monitor Output
(RF Power Meter)
8. One Watt Plus Output Available
9. Premium Quality Amperex Tubes
10. Broadcast Quality TV Flat Response
Amplifier

Planning replacement of your current system?
Designing a new system? In the long run . . . in the
short run . . . the best in quality equipment will save
you time, money and hard to get at winter time
repairs. Step up to quality . . . step up to M.A.R.S.

Mid America Relay Systems, Inc.

*Serving the Television World
from the Heart of America*

601 Main Street, Rapid City, South Dakota

Postmaster: Form 3547 Requested

BULK RATE
U. S. POSTAGE
PAID
Permit No. 53
Modesto, Calif.

P. O. BOX 3150
MODESTO, CALIFORNIA
U.S.A.