

JULY 1960

40 CENTS

DXing HORIZONS

TV - SHORTWAVE - FM

VOLUME ONE

NUMBER SEVEN

DEVOTED ENTIRELY TO RADIO AND TELEVISION DX RECEPTION

INTRODUCING THE

**BLONDER
TONGUE**

10th

Anniversary Line

better TV products
for better TV reception
... UHF & VHF

Today — nearly every American family enjoys television's wide range of entertainment and educational programming. Ten years ago this was not so, for there were problems that had to be overcome in order to provide the nation with top quality TV reception — weak signal areas, interference, areas geographically inaccessible to telecasts; areas where many antennas had to operate from a single antenna; UHF areas with peculiar reception problems. Ten years ago, Blonder-Tongue designed and produced its first product, a TV booster, the model HA-1. Immediately it was accepted for the dramatic improvement it brought to fringe area TV reception.

During the 10 year period in which the TV art achieved the advanced state that exists today, Blonder-Tongue was responsible for 22 important patents that expanded the scope and improved the quality of TV reception. Blonder-Tongue TV signal amplifiers, UHF converters, couplers, CCTV cameras and accessories provide better reception to more than 8 million TV receivers in the home, school, motels, hotels, hospitals and industry. To the nation's TV viewers, we dedicate our 10th Anniversary Line.

IT'S TRANSISTORIZED

to provide a new high in reliability—units can be left in operation indefinitely without damage from overheating. Practically eliminates need for service calls.

IT'S TRANSISTORIZED

to reduce operating costs — low power drain makes operating costs negligible. Also has battery plug for 22 volt DC supply.

IT'S TRANSISTORIZED

to achieve performance previously impossible —new circuitry (pat. pend.) provides maximum gain and minimum noise, high output capabilities with low cross modulation. Can be used with low input signals. Insures top performance for color and black-and-white TV, plus coverage of the FM radio band.

IT'S TRANSISTORIZED BLONDER-TONGUE BT-3

all
transistorized
broadband
tv/fm amplifier

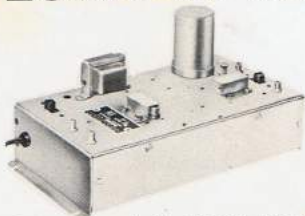

More features to make the BT-3 ideal for master TV systems.....List 99.50

- Separate low band (Channels 2 to 6 and FM) and high band (Channels 7 to 13) inputs permit the use of separate low and high band antennas and insertion of attenuators, if necessary, to equalize signal levels from both bands. Also has provision for single input for combined high and low band signals.
- Convenient Output Monitor Jack permits system checking and adjustment without interrupting service.
- Solderless 75 ohm coax cable fittings—input and output 75 ohm.
- Gain: 18—15 db (channel 2-6); 19 db (7-13); 15—9 db (88-108 mc.).
- Maximum output: 0.7 volts max. for 1% cross modulation (total of both bands); 1.25 volts max. for 3% cross modulation (total of both bands).

Available at parts distributors. For further information write Dept. DH-7.

B-T BLONDER-TONGUE LABORATORIES, INC. 9 Alling Street, Newark 2, New Jersey

In Canada: Telequipment Mfg. Co., Ltd., London, Ont. Export: Morhan Export Corp., N. Y. 13, N. Y.

**BLONDER
TONGUE**

10th
Anniversary Line

At Sign Off

NEW CATV SECTION FOR DXH

Some may agree with our various editorial approaches to the current legislation pending for the Cable TV Industry . . . others may not. However . . . few would disagree that the CATV Industry needs a clearing board for new designs and procedures directly pertaining to the field. The NCTA weekly membership bulletin does an admirable job of keeping Industry members informed of actual news, but it makes no attempt to cover technical advances. We believe DXH is uniquely qualified to fill this gap. And most important, we believe the gap should be filled. We therefore, are going to fill "the gap" with a monthly section edited by an engineer with long CATV experience and excellent weak signal VHF-UHF background. The new section, titled "CABLE DROP," will commence with the October issue of DXH.

SUBSCRIPTION REMINDER

Cable system managers—many have received several free complimentary issues of DXH, and some apparently believe someone else in the office has subscribed. Check your files, and be absolutely positive you have subscribed, because this is the last complimentary issue. Thank you.

EQUIPMENT DEPOT FOR BOOSTERS

Benco Ltd. (Canada), Blonder Tongue, and other manufacturers of VHF Booster-Translator equipment are said to be readying a plan to aid Booster operators in the forthcoming "change-over period" following the expected FCC licensing of this type of unit. According to preliminary plans, these companies will establish "Equipment Depots" in the northwest with the proper types of equipment in stock to facilitate the change over from the current Booster operations to standards meeting the "FCC Regulations." This will probably mean no wholesale changeovers of existing Boosters to meet the power, identification, etc. regulations adopted for "licensed Booster operation." Most existing boosters (other than "on channel boosters") will be able to make simple equipment additions, and modifications, to make operating units conform with the regulations. A one year changeover period is understood "in the text" of proposals.

All VHF Booster-Translators actually in operation on the date the regulations are passed and adopted, will be able to continue operations with the aforementioned year to change over (this is the so-called grandfather clause). HOWEVER, any units not in operation must go through the new FCC procedure of applying for a construction permit, awaiting FCC action on the construction permit, and THEN going into operation. The actual license is usually granted after operation has begun and the licensed unit proves satisfactory in all respects.

3 CONVERSIONS IN EAST'S FIRST BOOSTER!

In June we reported on a VHF Booster in operation between Lebanon, and White River Junction, New Hampshire. As the first known instance of a

VHF repeater east of the Mississippi, it has attracted considerable attention. We understand that it is re-broadcasting a signal that originates from WWLP-22, Springfield, Mass. on channel 22. However the actual air pick up for the channel 22 re-broadcasting unit comes from a channel 81 repeater. So the signal, originating on channel 22, is converted to channel 81 in a standard UHF translator, is then picked up at the channel 12 VHF Booster-Repeater site, reconverted to channel 12, and then rebroadcast with a final amplifier output of one-third watt on 12. Reports say signal quality is good. The VHF Booster uses a Blonder Tongue MLA unit for the final, and feeds a Conical type antenna for transmitting. The channel 12 signal covers approximately 10 per cent of Lebanon's TV viewers, 60 per cent of those viewers in White River Junction, and the region between the two towns, or about 4 miles.

CATV CONVENTION—Miami

A Photographic report, and review of events at the Ninth Annual National Community Television Association Convention held June 21-24 in Miami will appear in these pages in July. 16 Industry exhibitors and 700 individual CATV operators and their personnel attended the affair held in Miami's Hotel Fontainebleau.

TV DX'ers CONVENTION

TV DX enthusiasts throughout the MIDWEST are urged to contact DXer Tom Hidley at 6117 North Canfield Avenue, Chicago (Telephone Newcastle 1-1198), host for this year's AIPA TV DX Convention July 16 and 17 in that City. This well attended affair is best known for its rousing good time and lots of DX talk, as TV DXers from the entire country gather for a personal look see at their fellow hobbyists. DXers not able to attend are supplying taped greetings to their fellow enthusiasts. Have a great time fellows . . . wish we could be there! (DXH will supply a "Slide Talk" . . . slides with taped voice track . . . on one of our favorite topics . . . UHF TV).

HELP ASSOCIATES

is a new Rapid City, South Dakota firm specializing in finding qualified CATV personnel for systems operators. It is an employment agency just for CATV. Contact them at 607 8th Street (Room 204), Rapid City, S.D. for full information. Help Associates is headed up by Harlan Jacobsen, a gent with five years of CATV experience himself.

STATION NEWS

KORN-TV, channel 5, Mitchell, S.D. came on the air with NBC programs June 12. Tower height, with maximum power, is 569 feet. WGTV-8, Athens, Ga. educational station took to the airwaves May 23 with tests and programming between 1800 and 2300 EST. Full power, tall tower. WRBL, Columbus, Ga. reported on channel 3 last month is still on 4, as of late June, according to numerous southern viewers. Sorry! WJPB, Weston, W. Va. is reported on channel 5 now, from channel 35. Go get it!

VHF BOOSTERS LICENSED

The House June 24 passed the Booster Bill giving legal status to an estimated 1,000 VHF Booster-Repeaters. For full story see page 9.

TV-SHORTWAVE-FM

DXing HORIZONS

"A monthly news publication devoted to active Television, Shortwave, Broadcast Band, and Frequency Modulation (FM) long range enthusiasts throughout the world. DXing Horizons is registered to Robert B. Cooper, Jr., 1960.

"DXing Horizons is compiled by and for persons interested in furthering long range—weak signal reception of Television, Frequency Modulation, and Shortwave transmissions."

"In the weak signal Television-FM world, DXing Horizons is received and read by operators of Cabled TV Systems, UHF Translator stations, VHF Booster-Repeater, members of the Broadcasting Industry, and individual Hobbies and Experimenters."

"DXing Horizons maintains a technical advice service, and an Experimental laboratory where new products are tested, and new circuits developed."

"In the shortwave and Broadcast Band reception field, DXing Horizons provides the reader with accurate, timely, and complete reports on what is being heard, where, and by whom. Special reports of major interest to shortwave reception fans are also found in the monthly DXH departments."

DXing Horizons is the only magazine reaching the entire weak signal reception field, in 50 states and more than 70 countries monthly. Readership interest and acceptance guaranteed. Advertising rates upon request.

DXing HORIZONS
 P. O. Box 3150
 Modesto, California, U.S.A.
 Telephone LAmbert 3-4257

Publisher-Editor
 Robert B. Cooper, Jr.
 (Amateur K6EDX)

Circulation Manager
 Carole Buchanan

Shortwave Editor
 Kenneth R. Boord
 948 Stewartstown Road
 Morgantown, West Virginia

FM Editor
 Bruce F. Elving
 920 Laramie Street
 Manhattan, Kansas

Technical Editor
 Robert D. Grimm
 2800 Monticello Avenue
 Oakland, California

Broadcast Band Editor
 (Pending)

Every effort is made to assure the authenticity of material appearing in DXing HORIZONS. The publisher cannot be responsible for inaccuracies which may arise outside the normal publishing and editing duties. The staff does make every effort to enforce regulatory measures over editorial content.

All rights to material in DXing HORIZONS are reserved by the publisher. Reprint permission available on an individual request basis.

SUBSCRIPTION RATES

Canadian-U.S.A. Rates:

One Year.....	\$ 4.00
Two Years.....	7.00
Three Years.....	10.00
Airmail — One Year.....	7.00
Foreign Rates:	
One Year.....	4.00
Two Years.....	7.50

FEATURES

Page

WEAK SIGNAL TV	
the ULTIMATE TV RECEIVER	3
UHF-WHO WANTS IT?	5
TROPO SCATTER	
KLYD REPORT	7
WEAK SIGNAL INDUSTRY	
"Bringing TV to Marathon— CATV-VHF Booster News"	8
VHF ANTENNAS	
RUGGEDIZED YAGIS — "Stacking versus Gain-Patterns"	10
PRODUCT REPORT	
Winegard Transcoupler Yagis	12
TECH NOTES	
"Project Ionospheric Scatter— More 6CM4 UHF Pre-Amp"	14
SHORTWAVE STATION REPORT	
"Democracy's Mouthpiece—VOA"	20
SHORTWAVE PROFILE	
"Ans Boice — Floyd Backus"	22
SHORTWAVE	
"SWL'g, A National Pastime," part two	23

DEPARTMENTS

AT SIGN OFF (Last Minute TV-FM News)	1
TV REPORTING	16
FM REPORTING	18
"WORLD AT A TWIRL" (KFRN Report)	25
AT FADE-OUT (Shortwave News)	26

TV-SHORTWAVE-FM DXing HORIZON

"A monthly news publication devoted to a Modulation (FM) long range enthusiasts B. Cooper, Jr., 1960.

"DXing Horizons is compiled by and for reception of Television, Frequency Modulation. In the weak signal Television-FM world, TV Systems, UHF Translator stations, VHF and individual Hobbies and Experimenters.

"DXing Horizons maintains a technical department where products are tested, and new circuits developed.

"In the shortwave and Broadcast Band reception, timely, and complete reports on what is being heard, where, and by whom. Special reports of major interest to shortwave reception fans are also found in the monthly DXH departments."

DXing Horizons is the only magazine reaching the entire weak signal reception field, in 50 states and more than 70 countries monthly. Readership interest and acceptance guaranteed. Advertising rates upon request.

DXing HORIZONS
P. O. Box 3150
Modesto, California, U.S.A.
Telephone LAmbert 3-4257

Publisher-Editor
Robert B. Cooper, Jr.
(Amateur K6EDX)

Circulation Manager
Carole Buchanan

Shortwave Editor
Kenneth R. Baord
948 Stewartstown Road
Morgantown, West Virginia

FM Editor
Bruce F. Elving
920 Laramie Street
Manhattan, Kansas

Technical Editor
Robert D. Grimm
2800 Monticello Avenue
Oakland, California

Broadcast Band Editor
(Pending)

Every effort is made to assure the authenticity of material appearing in DXing HORIZONS. The publisher cannot be responsible for inaccuracies which may arise outside the normal publishing and editing duties. The staff does make every effort to enforce regulatory measures over editorial content.

All rights to material in DXing HORIZONS are reserved by the publisher. Reprint permission available on an individual request basis.

SUBSCRIPTION RATES

Canadian-U.S.A. Rates:

One Year.....\$ 4.00
Two Years.....7.00
Three Years.....10.00

Airmail — One Year..... 7.00

Foreign Rates:

One Year..... 4.00
Two Years..... 7.50

NO FRILLS...

NO FANCY CLAIMS...

JUST THE FACTS.

DXing HORIZONS is THE ONLY PUBLICATION OFFERING YOU WEAK SIGNAL TV-FM-SW NEWS MONTHLY.

And THIS COPY is YOUR LAST FREE COPY!

According to our records you have received at least two prior copies of this magazine, courtesy of DXH. Your failure to subscribe can only mean you are not interested. We do not feel that we can continue to supply disinterested readers with free magazines that could do better service elsewhere.

Your failure to return this subscription form with the \$4.00 subscription fee will automatically drop you from our mailing list. YES... enter my delinquent subscription to DXing Horizons today. Start me with the August issue... \$4.00 for 12 issues.

Name.....

Address.....

City.....

State.....

Subscriptions received prior to July 23 only will be processed to receive the August issue.

THIS IS YOUR LAST SAMPLE MAGAZINE!

the ULTIMATE TELEVISION RECEIVER

(Part One of Two)

by
James Gould
Kokomo, Indiana

and
Edited by DXH Technical Editor
ROBERT GRIMM

I.F. STAGE MODIFICATION

DXH PROJECT SHEET

Purpose: to develop a TV receiver with true weak signal gain, AGC and sync.

Method: conversion of existing I.F. stages to Amperex Frame Grid Pentodes (EF-184). Conversion of existing tuner to 6922 RF, crystal diode mixer, 6922 tuner mounted IF stage.

Results: Greatly improved audio, 40% better weak signal video sensitivity-sync-AGC. Video lock in range extended from 200 miles to nearly 300 miles under "normal conditions." J.G.

The idea of improving my TV set wasn't something that struck out of the clear sky. It is something I have been working on for the past two years.

Primarily, I have concentrated on improving my I.F. strip. The reason for this . . . I found I could materially improve the reception of weak signals by touching up the I.F. strip.

I have tried almost every circuit that exists in attempting to improve my set for DX use. However, it wasn't until the first issue of DXH that I suspected the transconductance of a tube was primarily responsible for its gain and noise-figure. With the information DXH has supplied on the new high transconductance tubes I have been able to come up with a high gain I.F. strip and a fairly low noise tuner. Along with this I have been able to achieve very high adjacent channel rejection, which is a necessity in a TV DXers receiver.

I don't think it will be necessary to go into details on the desirability of a low noise tuner as DXH has already dedicated much space on the advisability of low noise front ends.

I.F. IMPORTANT

The I.F. strip of a TV set is a very important part of the receiver. The quality of the picture, the contrast, and the rejection of adjacent channel interference depend on the I.F. strip. The addition of one or more I.F. amplifiers can improve the contrast, among other things, by increasing the gain.

AUDIO

In the average 1950-1955 models of TV sets the I.F. gain was fairly low even with four I.F. stages. A very weak signal (i.e. below 25 mu) will not hold sync. Even if it did occasionally hold sync, the pix is so infiltrated with snow, identification is virtually impossible. Generally these sets, and most of the newer models lack sufficient gain, and really fall apart when you try to receive the audio from a weak station. This is where high gain is of major

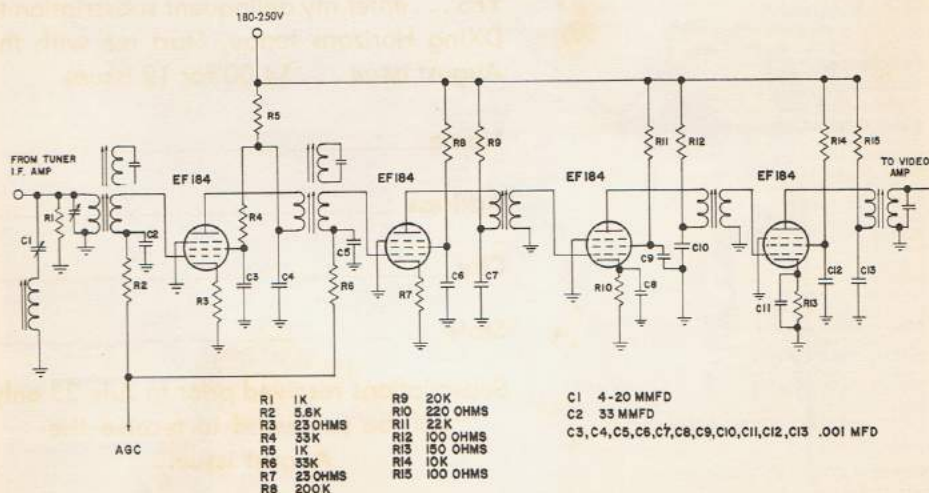

Gould Modified EF184 I.F. Strip

importance to the DXer. By contrast, a set having high I.F. gain will (through Amperev I.F. conversion), nine times out of ten give identifiable audio with any signal that barely comes into sync.

Such was the case this morning (late in May—Ed.) when I identified WTRF-7, Wheeling, W. Va. (300 miles) and last night when I identified WLOS-13, Ashville N.C. (400 miles). A reference set having normal gain did not give a trace of the signal. As an example of this, when I received WSIX-8, Nashville, Tenn. (400 miles), I attempted to receive it on the household TV set and not the slightest trace of a sync. bar was detectable.

EF-184

By using the Amperex EF-184's, a receiver's I.F. gain can be considerably improved. To increase your set's adjacent channel rejection at the first I.F. amplifier. These can be connected to the grid through 10 mmf. capacitors. If this reduces the gain too much, the capacitance can be decreased to 3 or 4 mmf. The ideal arrangement would use 4-20 mmf. trimmers. These can be tuned to the correct frequency by adjusting them when the set is tuned to a weak signal with a strong signal on the adjacent channel. The capacitors should be adjusted for minimum interference to the desired signal.

Using five I.F. amplifiers with 41 and 47 mc. traps gives excellent adjacent channel rejection along with very high gain and picture quality.

R.F., etc.

My set now has a cascode R.F. amplifier using a 6922, a crystal mixer, and a cascode first I.F. stage with a 6922. This is followed by four I.F. stages using EF-184's.

The conversion of my I.F. strip from 6CB6's to EF-184's was fairly easy and can probably be done in one or two evenings. I took my time and did it in three evenings. I rewired one stage at a time noting improvements as I went along. This way, if a wiring error is made it is relatively easy to find.

The rivets holding the seven pin sockets in place were drilled after the connections to the socket had been removed. In my particular set the nine pin sockets, for the EF-184's, fitted snugly into the vacated hole. In some sets enlargement of the socket hole may be necessary. After installing the nine pin socket the wires and components should be resoldered to the socket, with appropriate changes where necessary.

If desired you may use the present I.F. transformers. I wanted something a bit better so I installed some high grade units (Meissner 17-5002 and 17-5003).

RE-ALIGN

Whether the I.F. transformers are replaced or not, they will require re-alignment after the conversion is completed. If you feel brave you can use an on the air signal for this, but an oscilloscope and a sweep generator are heartily recommended.

Next month... A description of the tuner and cascode first amplifier. J.G.

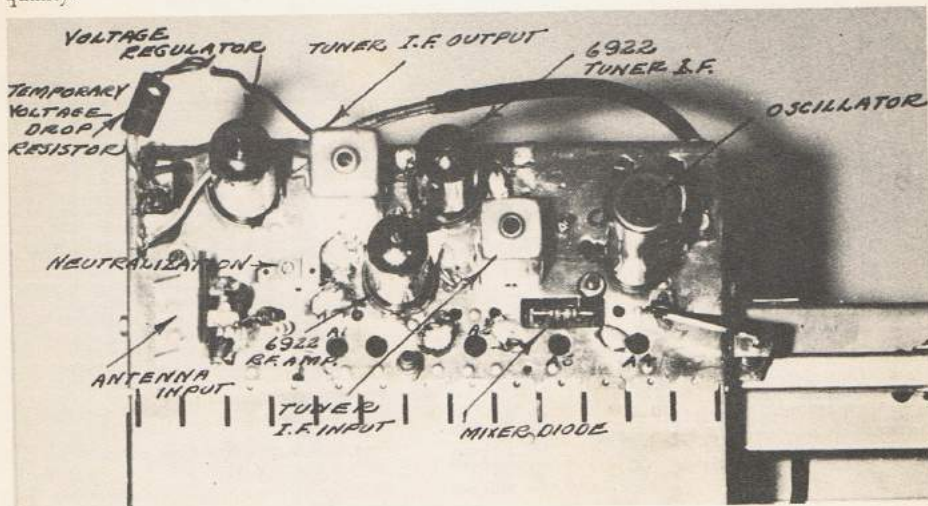

Gould Modified Tuner — 6922 — Diode — 6922

UHF - - -

"Who wants it?"

In March of this year DXing Horizons polled and received responses from ten percent of the operating commercial VHF-UHF television stations in the United States.

In our "DXing Horizons Operating Costs Survey Sheet," we asked the following questions of station engineers. "Do you personally believe an all UHF television system is economically feasible?" And, "Would you recommend an all UHF system over an all (expanded range of channels) VHF system for the U.S.A.?"

Although these two questions attracted the most varied answers of the 20 to be answered on our sheet, they did not tell the entire story. The prime object of our survey was to compare VHF vs UHF transmitter operating costs. It has been the contention of many foes of UHF television that even if the public could somehow be coerced into accepting UHF, the operating costs would drive the (necessary) high power UHF operator out of business. While such contentions (valid or not) may never receive any real attention at the FCC, we felt the accusation was strong enough to warrant looking into. Certainly it is important to the aspiring UHF operator. And it should be important to anyone desirous of being well versed on the subject of UHF vs VHF.

TUBE TYPES vs COST

In the VHF department we found operators were universal in estimating the life cycle of their final amplifier tubes. And while the life spans quoted in the following table are by no means "maximum," they certainly must be considered typical, and do give a good average.

Not all station engineers queried answered all 22 questions, by any means. We have therefore picked, for the basis of comparison, only those survey sheets answered completely by the engineering personnel. We did receive a 35 percent return of the survey sheets, which it must be remembered came from engineers and stations who had never previously heard of this relatively new publication. We therefore feel the response was very good, and indicative perhaps of the unusual interest in the UHF question.

VHF	Average Life Span	Cost of New Tube
Tube Types		
RCA 6166	6,000 hrs.	\$ 950.00
	7,000 hrs.	1,000.00
	6,000 hrs.	1,120.00
	5,000 hrs.	1,020.00
	8,000 hrs.	1,020.00
Machlett 7007	5,000 hrs.	1,050.00
	5,000 hrs.	1,200.00
UHF		
RCA 6448	5,000 hrs.	5,600.00
	10,000 hrs.	5,000.00
	5,700 hrs.	5,300.00
	6,000 hrs.	5,500.00
Varian 6440	3,000 hrs.	(tube leased at \$1.25 per hour)
Varian 6241	8,000 hrs.	(tube leased)
GE 6239	2,200 hrs.	(tube leased from GE)

SYNOPSIS

From the above table (abbreviated due to space limitations at this time) two factors are evident in UHF operation. In UHF, the final amplifier tubes are more expensive to operate and they may not last very long even after the high initial cost. On the other hand the highest claimed average tube life span is with an RCA 6448, an UHF tube . . . 10,000 hrs.

The two UHF tube types which give the lowest average tube life in this tabulation are leased from the manufacturer. One engineer (Max W. Thomas, WKNX-TV, channel 57, Saginaw, Michigan) revealed the GE 6241's his station leases from GE are cheaper to lease as they are used. After the first 2,500 hours, the rental drops to \$1.00 per hour, whereas after the 4,000 hour mark, the charge for tube use is only \$.75 cents per tube.

IS UHF ACCEPTABLE?

We left the answering of the two questions "Do you personally feel an ALL UHF television system is economically feasible?", and "Would you recommend an all UHF system over an all (expanded range of channels) VHF system for the U.S.A.?" to a voluntary basis. Half of the respondents returning the survey sheet indicated their personal beliefs.

The following chart shows how they answered the overall question included within the two quoted, "Can UHF be made to work."

UHF STATIONS ANSWERING

Total - 14

Yes - 12

No - 2

VHF STATIONS ANSWERING

Total - 12

Yes - 0

No - 12

It is perhaps significant that the two UHF stations answering in the negative were in a single market, with one competing VHF station. At the time of the survey (in March) the FCC winds were favoring an all VHF market for the area. Both stations favored this change over. In the interim period the FCC winds have changed their course and the area will soon be all UHF (Fresno, California).

COMMENTS

With several of the returned survey sheets came letters of further explanation and strongly expressed opinions by many of the nation's top UHF TV station operators.

Arthur O'Neil, Chief Engineer at the nation's oldest "operating UHF station," WSBT, channel 22, South Bend, Indiana, notes "tube life (final amplifier) is increasing as techniques improve, and some tubes have been good to 15,000 hours." WSBT uses the RCA 6448, with 7.5 kW peak visual output (black level).

Robert M. Cleveland, Chief at WEHT, channel 50, Evansville, Indiana has this to say about UHF vs VHF. "Compared with drop in VHF, all UHF would be 1,000 percent superior! The best system would utilize both UHF and VHF with complete de-intermixture in each market (emphasis not ours... Ed.). It is also time to realize TV station coverage should be limited to the market being served. With such (practical) limitations a system of UHF and VHF Translators would suffice to complete blanket coverage of the U.S.A."

But DXing Horizons feels that Engineer Arthur O'Neil of WSBT, South Bend, sums up the current problem, and he offers some promise of an expanding future for UHF, as VHF in the mid-west continues to beat itself to death in fringe areas with increasing co-channel interference.

Mr. Neill states "We are very pleased with the service that UHF television provides to the viewers in our area. Acceptance has been very enthusiastic and as the country's oldest operating UHF station, we report complete success in providing television to this area. Needless to say, all viewers in our service area are able to receive us well, and even more heartening is the fact that we are gradually gaining new viewers in areas formally VHF. This would appear to be due primarily to co-channel and adjacent channel interference of VHF stations becoming increasingly serious, as these stations go to maximum power and tower heights. Thus even our fringe areas are being pushed out since we can offer "interference free reception.

And the Chief Engineer for South Bend Tribune station comments on the future of a VHF only system in the U.S.A. "... anything short of expanding the number of VHF channels would not make VHF practical for the future expansion of television." (Eds. note... see "At Sign Off" for late word on the chance for additional VHF spectrum space.)

DXH BELIEVES

That the proper solution to the UHF vs VHF problem is the complete de-intermixture of VHF and UHF operations in the numerous regions where local television is UHF television. Our own engineering advances convince us UHF fringe area reception (through the use of proper antennas, low noise preamps, and installation techniques) can be made every bit as practical as fringe area VHF reception, which is largely a matter of putting the antenna higher in the air. At UHF frequencies we can offset the disadvantages of wave propagation with the much lower RF stage noise figure than can be used on VHF, and larger-higher gain antenna arrays. And, if the FCC doesn't get carried away with channel allocations, UHF will have the natural advantage of "elbow room," and the resulting "almost complete lack" of co-channel interference... one of the prime factors in poor VHF fringe reception over two-thirds of the country today.

Now we know UHF can, and does work. Let's see "How we make it work!"

TUNNEL DIODES FOR UHF

Work on the DXH Parametric Amplifier has been temporarily discontinued as we go "full steam ahead" on a tunnel diode unit using one of the Texas Instruments 1N650's. A preliminary report in August.

KLYD Tropo Scatter Report

May 26 will long be remembered around the DXing Horizons lab testing corner in Modesto. That was the day we discovered (much to our initial surprise) that a very weak border line signal from UHF channel 17, KLYD, Bakersfield, California could be noted almost at will—day or night. The path from the KLYD transmitter site to our low noise UHF receiving station is over the southern portion of the flat San Joaquin valley floor. There is not the slightest hill nor rise in the terrain over the entire 218 mile path. It is essentially a smooth sphere of near desert type terrain where daytime temperatures rise to 100 plus degrees, and the hot valley floor cools to 40-60 degrees at night. We point out the nature of the desert terrain to heighten our preliminary conclusions that the signal we are receiving is of the tropospheric scatter variety (by theory). Pure ground wave range is vastly affected by the amount of ground conductivity between the transmitter and receiver. The attenuation of the ground wave signal is rapid especially where the terrain is of low conductivity. Desert type terrain is of the lowest order of conductivity known. It falls far below sea water (the lowest attenuator and therefore the best ground wave path), marsh land and so called average terrain.

AVAILABLE SIGNAL

We are inclined to suspect true tropospheric scatter reception because of the signal's constant "average level." Except under rare inversion conditions, the signal level is barely enough with our present receiving equipment to produce a detectable frame bar and faint traces of video detail in the snow. Audio is not present except under inversion conditions. The signal level "painfully measured" on a Radion UHF-VHF Field Strength meter is just enough to show an indication of a reading (video carrier), perhaps of the order of 5 mv above the receiver noise level. The frame bar signal is detectable 90 per cent of the time from mid morning checking time until near midnight. All inversions noted (bringing the signal level up) have occurred after 2130 PDT, and before 2245 PDT. In this portion of the west, they are known as "heat inversions."

EQUIPMENT

Amazing as it may sound, our UHF test antenna (at this writing) remains but 20 feet above ground! Below tree levels! The antenna that is producing this amazing consistent signal is the Channel Master Model 425 Para Scope. The precious microvolts are fed through 29 feet of foam filled UHF transmission line to the new Blonder Tongue BTU-2S converter. Using an IF of channel 5, the signal feeds a Mattison receiver (described in the June DXH).

KLYD

300 kw. visual ERP from a 440 foot tower 660 feet above ground. Grade B service extends to a point slightly north of Visalia, or nearly 125 miles south of our receiving site.

(Continued on page 15)

It's the **EXTRAS**
that
make a
good
tube
GREAT!



Amperex[®] 866AX MERCURY VAPOR RECTIFIER

with these **Amperex EXTRAS:**

- threaded removable plate cap
- improved heat dissipation
- compact bulb size
- no loose base problems
- direct interchangeability with the 866

MAXIMUM OUTPUTS IN TYPICAL CIRCUITS

	AC Input Volts RMS	DC Output Volts to Filter	Max. DC Load Current Amps.
Single-Phase Full Wave (2 Tubes)	3535*	3180	.5
Single-Phase Full Wave Bridge (4 Tubes)	7070†	6360	.5
Three-Phase Half Wave (3 Tubes)	4710‡	4780	.75
Three-Phase Double Y-Parallel (6 Tubes)	4080‡	4780	1.5
Three-Phase Full Wave (6 Tubes)	4080‡	9570	.75

*per tube †total ‡per leg

Other ham favorites by **Amperex:**

ECC81/12A7	Low-noise, medium- μ twin triode
ECC82/12AU7	Low-noise, low- μ twin triode
ECC83/12AX7	Low-noise, high- μ twin triode
5894	High-sensitivity VHF/UHF twin tetrode; 40 W anode dissipation
6146	High-sensitivity beam power tube
6360	Miniature VHF twin tetrode; 14 W anode dissipation

At all leading
radio parts distributors



ask **Amperex**
about extra-quality
ham tubes

Amperex ELECTRONIC CORPORATION
230 Duffy Avenue, Hicksville, L. I. N. Y.

WEAK SIGNAL INDUSTRY

BRINGING TV TO MARATHON

(Part One of Three)

This three part series, prepared exclusively for DXH readers in conjunction with Grant D. Ross, former town manager, will cover in detail the problems of bringing television to an isolated town of 2,500 people more than 130 miles from the nearest video station. Parts two and three will include building details for VHF rhombic antenna arrays.—Ed.

Marathon, Ontario . . . a company town owing its very existence to the Marathon Company (a Division of American Can). In the summer of 1953 Town Manager Grant Ross decided on a series of experiments that he hoped would bring TV to Marathon's isolated residents. Marathon's isolation can be traced to its location on the north shore of Lake Superior, just south of the 49th parallel, 131 miles east of Port Arthur, Ontario. The town lies in a natural valley, but this did not daunt experimenter Ross. First an all channel array was erected on a 60-foot tower near Ross' home. It brought the usual share of tropospheric signals (Wisconsin, Michigan, Illinois, all more than 300 miles) and a host of E skip signals throughout the summer and fall of '53. Soon Ross was convinced a useable signal could be managed on a nearby hill, from WBAY, channel 2, Green Bay, Wisconsin. Green Bay is 305 miles due south of Marathon!

The first antenna chosen for the WBAY tests was a six wavelength per leg Rhombic, mounted 45 feet above ground and at a height 300 feet above the lake. The well constructed Rhombic (to be described in detail in subsequent issues) produced identifiable signals over the 305 mile WBAY path 95 per cent of the time, which Ross breaks down this way. Good reception, fifty per cent of the time, fair to good, twenty-five per cent, fair to poor the remaining twenty per cent.

TROPO SCATTER

The signal left the WBAY turnstile at an elevation of 1,150 feet msl, and then over gently rolling countryside for a distance of 152 miles, to the south shore of Lake Superior. From the south shore to Marathon's north shore location, the signal scattered over open water . . . an additional 153 miles.

The Rhombic was in use consistently until the fall of 1955, or nearly 18 months after its installation. During that time Ross piled up 50,000 words of testimony covering the fading effects, effects of weather, and the results of antenna modifications. The Rhombic's broad band characteristics were

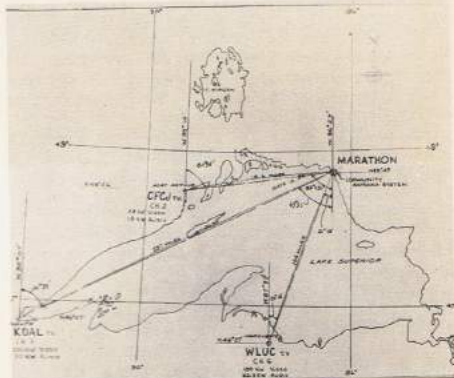

Present Marathon scatter paths in service.

clearly evident in the "nearly as good reception" managed from WFRV-5, and WMBV-11, also Green Bay.

In the fall of '55 CFPA came on the air in Port Arthur, Ontario, on channel 2. This effectively ruined WBAY reception, so a yagi array was erected for the CFPA signal. Additional yagis were also installed for WLUC, a new channel 6 in Marquette, Michigan, 166 miles directly across Lake Superior.

But of interest to DXH readers is the data compiled by Ross in the Rhombic installation and adjustment. Despite the rapid advances in yagi configurations in recent years, the Rhombic antenna remains the most sensitive for those who have the room to take advantage of its signal catching abilities.

SIGNAL DISTRIBUTION

From the standpoint of a Community Cable TV System, the Marathon installation is not at all unusual. Nearly 400 home subscribers watch their two channels (CFPA, WLUC), having paid a \$50 installation fee and a monthly cable rental charge of \$2.50. A pair of technicians are employed to service the cable, make new drops, and keep the town's receivers perking. Benco Ltd. Cable TV equipment is used throughout the system.

The initial tests with the WBAY signal fed the Rhombic antennas output through 1,800 feet of 450 OHM open wire line to the Ross home where observations were conducted.

A Blonder Tongue MLA unit provided line amplification after suitable matching to the coaxial input.

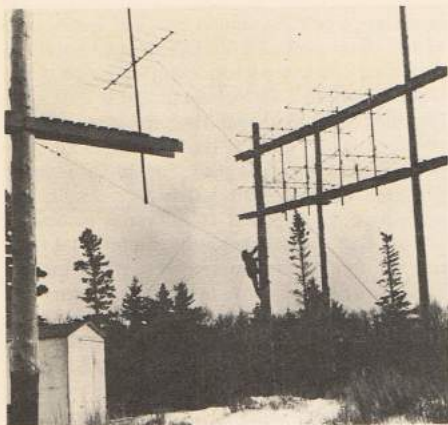

Yagi antennas in service currently—for CFPA and WDMJ.

LAW OF THE LAND — STEP ONE FOR CATV

The CATV industry is a strange one in many ways. It grew by its bootstraps from the most meager of beginnings in the mountains of Oregon and Pennsylvania. And for nearly a decade it grew, unregulated for the most part. But suddenly, or so it seems, everyone in the broadcasting industry wants it regulated. Brought under control, and in extreme cases, stamped out.

Cognizant the best way to beat away those parties screaming for CATV blood is to adopt some form of regulation on our own, the industry itself, under the guidance of the industry organization, the National Community Television Association, has set out to find suitable legislation. It has not yet, apparently, found "appropo legislation." But, perhaps "CATV law" will land on the books in another way through the Judicial "back door."

HELENA, MONTANA

A Montana District Judge has ruled that a television station has no property rights in the programs it broadcasts. The decision, although involving only Montana law and a local (Helena) case, is viewed as having nationwide implications on the television industry. It is the nation's first court ruling regarding television property rights.

The judgment, handed down by Judge W. W. Lessley of Bozeman, Montana, favored Helena Television, Inc., a CATV system. Helena TV was the defendant in a case brought by the "Z Bar Net," and television stations KXLF, Butte, and KXLJ, Helena.

Z Bar Net, KXLF and KXLJ sought a court order designed to force Helena TV from picking up the signal of KFBB in Great Falls, and distributing it to the 2,500 subscribers of the Helena TV Cable System. KFBB, through off the air pick up, rebroadcasts many programs beamed from the KXLF transmitter. KFBB does so with the permission of KXLF.

Based on this fact and other considerations, Judge Lessley ruled that the plaintiffs "Have no property interest, by copyright or otherwise, in any

programs broadcast by television station KXLF, or in any signals or programs received on the defendant's Community Antenna System . . ."

The Judge noted that by permitting KFBB-TV to rebroadcast its programs, the Z Bar Net "intentionally made them public."

It must be emphasized that this Montana ruling is a local one, and in no way affects future law suits that may be drawn up in other states. However, it may be referred to by CATV attorneys who are forced to make similar defenses in future cases.

Nor does this ruling affect what is understood to be pending litigation by various copyright film and program owners (as opposed to broadcasters) who are seeking to take into court a test case aimed at preventing CATV installations from carrying copyright protected film and network shows. Such a case, if won by the opponents of CATV, could certainly drive CATV out of business over night. This, we believe, poses a greater threat to the future of CATV than any pending Washington legislation.

Thus CATV's future in many ways has just as much to fear from our Government's Judicial branch as from the Legislative branch. And without the natural benefits of lobbying found in Legislative action, the Judicial fight will surely tax the very limits of ingenuity that our CATV operators can muster.

CATV LEGISLATIVE REPORT

During a House Sub Committee Booster Hearing held June 6-7 in Washington, Sub Committee Chairman Oren Harris (D.—Ark) stated he believed that some form of CATV regulation would be passed "by the next session of Congress." Observers took this to mean that the May 18 recommitment of the CATV Bill in the Senate was a permanent shelving of the CATV matter for this session.

HOUSE ACTION EXPECTED DAILY — BOOSTERS

VHF Booster Operators, beseeching their respective Congressman for nearly two years to enact legislation to modify the existing Communications Act, and legalize VHF Boosters, will heave a collective sigh of relief soon. It appears that "almost suitable" Booster legislation will be passed by the House about the time this is printed.

In Washington hearings held before the House Commerce—Communications and Power Sub Committee June 6-7, the way was cleared of all major pre-passage obstacles. The Senate passed a VHF Booster Bill last fall. There being no apparent opposition at this time to the pending Bill, a quick action "calendar call vote" is expected.

Although the details are necessarily being held under cover as this is written, here are a few "educated guesses" of what will be included in the Bill's final form.

The FCC will see that:

- (1) Maximum Booster power be limited to one watt input.
- (2) All licensed stations receive 100 per cent protection of all "off the air pickup" of signals. (i.e. no 100 mc contour regulation . . . but complete protection, even into the deepest fringe regions.)

(Continued on page 13)

RUGGEDIZED Antennas

For Weak Signal VHF

(Part Two of Three)

By F. R. Voorhaar
The Technical Appliance Corp.
Sherburne, New York

In the June issue of DXing Horizons we discussed the general considerations for ruggedized yagi antennas in VHF.

This month's second installment will be confined to the proper combination of two or more antennas into an array, to achieve sharper patterns and higher gain for long range reception.

Ruggedized antennas designed by Taco have an "in built balun," whereby the terminal impedance at the feed line connection point is transferred to 50 ohms. Then by employing coaxial stacking, or combining lines having a 72 ohm impedance, and using lengths of coaxial line which are odd multiples of a quarter wavelength (propagation factor for the coax applied) at the desired frequency, it is impossible to transform the normal 50 ohm

impedance of the antenna to a line impedance of 100 ohms (50 plus 50). When two antennas and their associated connectors are combined with a simple "T" connector, the 100 ohm impedance halves, resulting in an input impedance of 50 ohms at the "T" connector output. It follows that this "array combining process" can be expanded from a single bay antenna to 2, 4, 8 and 16 antennas combined as one. Experience has demonstrated that from the standpoint of economy vs. performance, an array of 8 or 16 bays is the largest practical. *By calculation, each time we double the number of antenna elements, we increase the total array gain by 2.5 db.* While this may be worth while as we go from a single yagi to two, and even from two yagis to four, it becomes increasingly less worthwhile to continue to double the number of elements (individual yagis) for the additional 2.5 db gain. On this basis the user must determine the value of increased signal, when compared to increased cost. In practice it has been found that 8 bays (or at most 16) is the greatest number that can justify the additional cost involved.

ONE YAGI — BASIS OF A SYSTEM

Taking our figures from the measured gain of a ten element yagi with an average forward gain of 10 db, we find that doubling up by the addition of

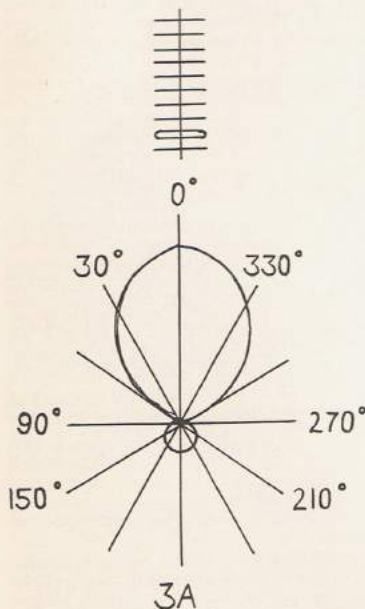

SINGLE YAGI PATTERN

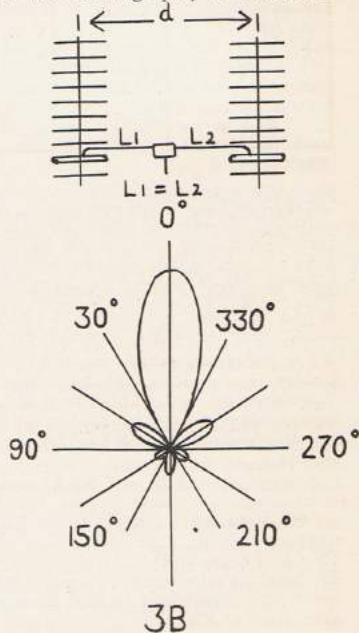

ONE WAVE LENGTH
HORIZONTAL STACKING
TWO YAGIS

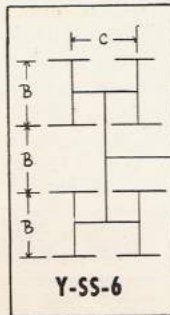
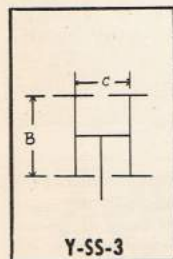
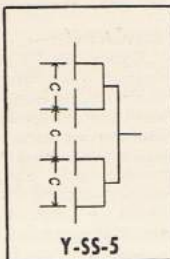
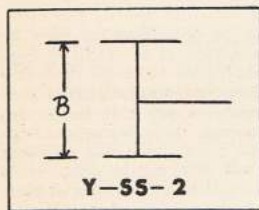
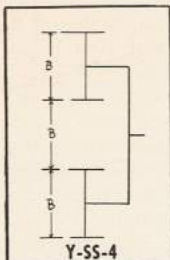
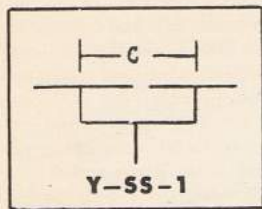

Y-SS Phasing of Yagis

another antenna into a two bay array, we attain a total gain of 12.5 db. The expansion of the array to a four bay array increases the gain to 15 db, with a further increase to 17.5 db gain with 8 total yagi antennas properly phased and matched. 16 bays combined into a single array will net an additional 2.5 db for a total 16 bay yagi gain of 20 db.

The foregoing should not be interpreted as a statement that multiple yagi arrays are not frequently necessary, for we know that the added gain can well mean the difference between a useable picture, and one that cannot be used. Operators of community cable systems are well acquainted with this fact and many multiple unit installations are used to provide daily reception to remote areas.

STACKING ARRAYS

Many stacking configurations are possible with two, four, eight and sixteen bay arrays, and several are shown in the "YSS stacking figures" illustrated. The proper stacking dimensions shown for the separation of antennas has been determined by both theoretical calculation and actual practice. A spacing of one-half physical wavelength is shown for vertical spacing in YSS-2, while three-quarter

wave physical spacing is necessary when arrays are stacked in collinear fashion, as shown in YSS-1. Spacing of less than the recommended fractions of a wave length will result in reduced gain and broader frontal beam width. Spacings in excess of those recommended will produce a narrower beam pattern and somewhat higher gain, up to 1.5 wave-length spacing.

However at the same time, while improving the frontal pattern the side lobes of the pattern will deteriorate. The proper spacings are given in Chart One for channels 2 through 6, 7-13, and a set of compromise spacings (for low and high band yagis), shown as 50-90 megacycles (2-6) and channels 7-13.

Frequency-channel	Stacking Dimension	Stacking Dimension
	B (inches)	C (inches)
2	104	156
3	94	140
4	86	128
5	75	112
6	70	104
FM	60	90
7	33	50
8	32	48
9	31	47
10	30	46
11	29	44
12	28.5	43
13	28	42
50-90 (2-6)	85	126
7-13	30	46

Chart One

SPECIAL PATTERNS

In areas troubled by severe co-channel or adjacent channel interference, rejection of unwanted signals is of more concern than the need for inmaximum gain on the desired channel. A logical solution to this problem is to locate a null in the pattern at the angle of arrival of the undesired signal. Within certain limitations this can be accomplished in the combining or stacking of the antennas comprising the array.

Let us consider two antennas combined horizontally as in Figure 3B, and separated by distance "D." If the angle of arrival of the interfering signal is 90 degrees, or perpendicular to the crossarms of the antenna (i.e. elements), and the two antennas are spaced (distance D) at one-half wavelength, then the signal picked up by these combined antennas will be 180 degrees out of phase. Since the antennas are combined through equal lengths of transmission line (L1 and L2), the two signals will effect cancellation of the undesired signal.

The previous paragraph cites a theoretical case ... in actual practice the normal 90 degree null (arriving at right angles to the array) in the yagi pattern should provide the necessary rejection.

But ... given a situation where the angles of arrival are other than 90 degrees from the antenna plane, it becomes apparent that the spacing between two horizontally stacked antennas must be increased to accomplish the necessary 180 degree phase shift between the signals received by the antennas. This spacing will increase as the angle

(Continued on page 13)

DX PRODUCTSthe **WINEGARD TRANSCOUPLER YAGI**

For sheer gain on any single channel there is still no substitute for "number of elements" on a properly engineered length of boom. Which is another way of stating that all channel antennas designed for both high and low band use have not yet developed to the extent that they can replace high gain cut to channel yagi arrays for the discriminating user. This should include you as a weak signal enthusiast.

Recently, however, the Winegard Company of Burlington, Iowa introduced to the weak signal market what at first glance appears to be a pure yagi configuration. It's called the "Transcoupler Yagi," a name derived from the design used by Winegard engineers to phase the twin dipole elements (of the low band model). Basically the Transcoupler Yagi (whether it be the high or low band model) is a 12 element broad band device with narrow band single channel characteristics.

Its gain, front to side and front to back patterns all compared favorably with single channel ten element yagis in test at DXing Horizons. But more of the testing of the Transcoupler series shortly.

16.5 FOOT BOOM!

The low band model (TC12-26) is one of the largest mass produced yagi antennas we have ever had in the air, in a decade of long range TV experimentation. From tip to tip, it measures 16 and one-half feet in length, 12 elements . . . two reflectors, a pair of driven elements. The low band model also comes with a boom brace. The antenna boom itself is shipped in three sections. The entire antenna is anodized aluminum construction. While the antenna is large and a bit unwieldy, it is balanced properly at the boom-mast joint and is surprisingly light weight (i.e. we balanced it above our head with one hand while dropping it down over the mast, all of the time perched with only a leg hold on top of a crank up tower!).

TC12-713

The high band model Transcoupler yagi, while large as high band yagis go (11 foot boom for 12 elements) can easily be handled while hanging onto the top of a swaying 90 foot tower with your teeth! And yet despite its lightweight construction (again-anodized aluminum), it is sturdily built and one of our test units withstood a 25 foot drop to the ground with no apparent ill effects (the dropping exercise was NOT part of the general testing program!).

The TC12-713 uses flip out elements, which should appeal to the installation set. While we still prefer the good old fashioned "swing it out, position it and screw it down" variety, we must admit that the flip out elements on this particular unit stayed "flipped." Once the element is flipped out from the boom, two rigid "fingers" grip it firmly, assuring that it will stay in place.

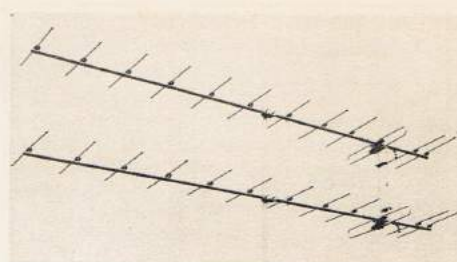

Winegard Transcoupler TC12-713

STACKING

Either the TC12-26 or the TC12-713 may be stacked. For testing purposes we stacked two high band models (see photo), above a single stack low band unit. "Phasing bars," an integral part of each antenna matching system (to 300 ohm line) "flip down" to form stacking bars on both low and high band models. Thus the buyer need not purchase special stacking bars, and there can be no question about the proper stacking distances, length of bars, etc. Winegard has done the thinking for you.

PERFORMANCE!

Our reference antenna during the following quoted tests was a '55 vintage CL-4 Winegard (prior to the tri reflector system CL4-X). It was mounted on the same tower, and at the same height, as the TC Yagis. All quoted field strength measurements are averages taken over a month long period and do not reflect daily changes in conditions of extended ground wave. The readings were taken with a "RADION VHF-UHF Portable (battery operated) Field Strength Meter."

TC SERIES YAGIS vs CL-4 ALL CHANNEL YAGI

(Gain characteristics—forward lobe only. All readings are video carrier only. Low band TC Series readings taken with single 12 element antenna; TC Series high band readings taken with stacked 12 element (24 elements) antennas.

(mv/m-Radion F/S unit)

Channel	CL-4	TC Series	Station
2	300	420	KTVU—82 miles
3	475	600	KCRA—78 miles
3	00	15	KEYT—265 miles
4	520	675	KRON—82 miles
5	225	525	KPIX—82 miles
6	775	1100	KVIE—57 miles
6	10	25	KVEC—160 miles
7	575	1200	KGO—82 miles
7	00	60	KVIP—240 miles
8	1800	3800	KSBW—60 miles
8	30	65	KOLO—140 miles
9	600	1400	KQED—81 miles
10	1900	2500	KBET—57 miles
10	30	45	KERO—205 miles
11	150	275	KNTV—60 miles
12	350	550	KFRE—80 miles
12	80	120	KHSL—160 miles
13	3100	5000	KOVR—55 miles

Chart One**DISTANCE — Reliability**

In that order, distance and then reliability, readers will probably judge the TC series performance.

(Continued on page 19)

WEAK SIGNAL INDUSTRY

(Continued from page 9)

- (3) No booster operation on channels 4 and 5, thus protecting Aviation Channels between 72 and 76 megacycles.
- (4) No on channel operation. (i.e. All VHF Boosters will be "Translators" with channel conversion between channel received and the channel selected for retransmitting.)

The FCC is reportedly studying a plan offered by Milton Shapp of Jerrold Electronics Corporation, Philadelphia, to divide the U.S.A. into two "zones." One zone would include all of the Western United States (and Alaska), the second would include the general area east of the eastern Rocky Mountain foothills. Booster expansion would be prohibited (in this plan) outside the western zone.

All Boosters now in operation would be granted retroactive licenses dating back to the date of their first operation, "IF" they can meet the various power and (detailed) technical requirements eventually written into the law. This is the so-called "grandfather clause."

WYOMING BOOSTER MEET

Arriving too late for this issue of DXH is a report on the meeting held in Casper, Wyoming June 18-19 by Wyoming TV Booster operators. We are grateful to Jim Beamer for passing out copies of the June DXH to those in attendance! A complete report in August.

RUGGEDIZED ANTENNAS

(Continued from page 11)

of incidence approaches the plane of the antenna (i.e. the front lobe). The required spacing (for phase shift) becomes impractical in the areas plus and minus five degrees of either the front of the antenna (355 degrees through zero to plus five degrees) or the back of the antenna (175-185 degrees).

To verify the above information, experiments were conducted, using two ten-element yagi antennas with variable horizontal spacing. Agreement between the calculated and measured separation and stacking points is very good. Obviously, the same method will also work with 4, 8 and 16 bay yagi arrays.

It must be pointed out that there are some severe restrictions to the application of this process of phase shift. The nulls will tend to be quite sharp, and become increasingly so as the horizontal spacing (distance "D") is increased. Also, a complete null is achieved only when the signal of the two (or more) antennas is of equal magnitude. Distortion of the signal field or variation in the impedance of the antennas used will cause some deterioration of the null.

Readers desiring additional information on this method of minimizing interference are invited to contact Taco direct, at the Technical Appliance Corporation, Sherburne, New York, requesting R. T. Leitner's complete report on Minimizing Interference.

*best at any
site for
DXing*

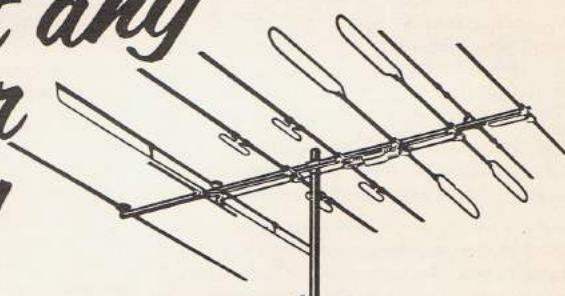

TACO

Topliner

TELEVISION ANTENNAS

Outperforms them all—by far!

WRITE FOR
COMPLETE DETAILS

TECHNICAL APPLIANCE CORPORATION
SHERBURNE, NEW YORK

TECH NOTES

Edited and prepared by DXing Horizons Technical Editor

ROBERT GRIMM

2800 Monticello Avenue, Oakland, California

PROJECT SCATTER

Project Scatter is underway! The object of "Project Scatter," as previously outlined in the April issue of DXH, is to attempt the reception of a channel 2 TV signal from a station approximately 950 miles distant by means of *ionospheric scatter*. This is not to be confused with meteor scatter or Sporadic E that most DXers are familiar with. We are not interested in the strong burst signal nor the Es skip signal, but rather, in the *very weak, fluttering, fading, residual signal* that is always present in the absence of bursts. *This is the true scatter signal.*

Channel 2 has been chosen for this project as it is the lowest frequency channel (video carrier—55.250 mc.) and therefore the most favored for this mode of propagation. The station chosen for our tests is CHCT, Calgary, Alberta, Canada. This station has an e.r.p. (effective radiated power) of 100 kW.

AMATEUR RESULTS

For the past several years, amateurs have been communicating quite successfully by means of ionospheric scatter in their six meter band (50-54 mcs.). The distances involved are 700 to 1400 miles. The power used has ranged from 100 to 1,000 watts. True, high gain antennas, narrow bandwidth receivers and the use of c.w. were all essential to receiving these very weak scatter signals.

Now, in using a TV station with an e.r.p. of 100 kw., we will have quite a fair amount of signal to work with, and *if we were able to use narrow bandwidth techniques* (approx. 1 to 3 kc.) we would be virtually certain of receiving a fair signal very consistently. Unfortunately a TV receiver, of necessity, has a wide bandwidth (approx. 4.5 mc.) and this is the big limiting factor. We shall now see what can be done about this.

RECEIVER GAIN

There are four things that can improve the signal to noise ratio of our receiving system; 1) Increase the size and capture area of the receiving antenna system. Here we can gain quite a bit, but is still not enough for consistent reception.

2) Improve the noise figure of the tuner in the TV set. In some cases this may effect an improvement, but in the majority of cases little is to be gained from low noise techniques in the receiver front end *at this relatively low frequency*. On higher frequency channels, where the atmospheric noise level is much lower, it would be a definite asset.

3) Narrow the bandwidth of the TV receiver. This is probably the greatest single improvement we can make to facilitate the reception of weak signals. We are not interested in the audio portion of the signal so this fact alone will allow us to narrow down the bandwidth without affecting the video. There is a definite limit as to how far we can go in this direction, however. If we narrow the bandwidth too much we are going to lose definition. We can tolerate this to a point as we are interested only in receiving an identifiable signal and not in how distinct it may be. Exactly how far we can go in this direction is not known at present but we are in the process of finding out. Tentative estimates are that we can go down to a 1.5 mc. total bandwidth with little difficulty.

We are currently working on an i.f. strip of reduced bandwidth, utilizing the recently released Amperex EF-183/6EH7 and EF-184/6EJ7. The sync. circuits will also be "hopped up" to enable them to better lock in an extremely weak signal.

The tuner will be modified for operation on one channel only to reduce circuit losses.

While few DXers will want to make the wholesale changes to a TV receiver that ours is undergoing, all of us will gain a lot of useful information from this, to improve set performance on weak signals.

MORE TECH NOTES

IMPROVING OLD RECEIVERS

Many older receivers, whose performance has fallen off at the higher frequencies, can be improved by replacing the r.f. and i.f. bypass capacitors. *Disc ceramics would make the best replacement type in the front end.*—RDG.

NIGHT SHOW

TV reception not as good as it used to be? *The twin lead could be the cause of the trouble.* If there are any visible cracks in the insulation the lead should be replaced. A good check on twin lead is to flex it between your fingers. If it is brittle or crackles when you flex it, it should be replaced. Dirt and moisture get in these cracks and effectively short out the antenna system. This is the primary cause of a pix that gets snowy at night.—RDG.

MORE 6CM4

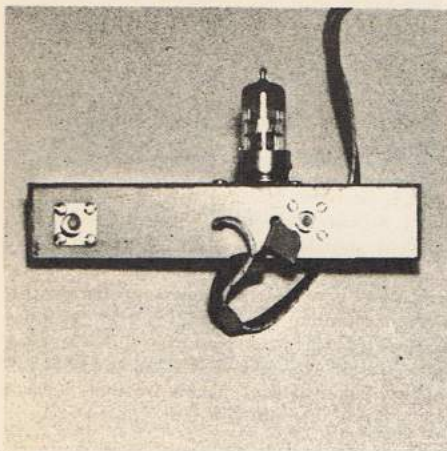

No. One

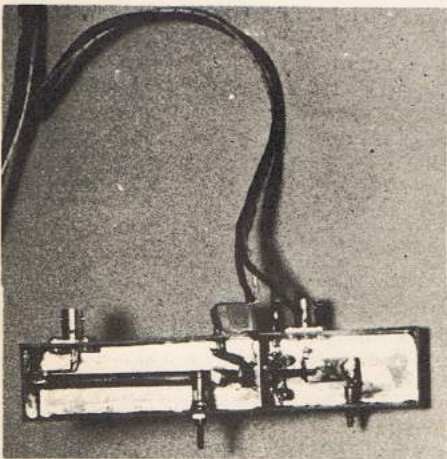

No. Two

Photo one above shows our experimental UHF pre-amplifier in service in mid-June at DXH. Input (left) and output coaxial connectors show on the front side facing with the 6CM4 tube, socket top, mounted top side. The wires connecting to the front carry B plus (175 volts), 6.3 volts for the filament, and a ground connection.

The entire assembly is constructed of copper clad phenolic board, which cuts like fiber board, and solders together in a matter of minutes. It consists of five separate pieces . . . two sides and a top each seven inches long by 1 1/4 inches wide, and two end pieces each 1 1/4 inches square.

The bottom photo (2) shows the UHF pre-amplifier innards. On the bottom, the feed thru connectors for the voltage connections. On the top, the plate line tuning capacitor (C2 in schematic printed with complete article in June), on the top left, the cathode tuning capacitor C1. Both are .5-3mmf piston trimmers. The socket base is seen in the center, with the copper shield running across the board to isolate the input and output circuits from one another. The grid pins on the socket (2, 6, 8) are soldered directly to the shield, grounding them. The shield is soldered to the walls of the pheno board sides on both ends.

The long dark line on the right hand side is of course the plate line, 1/4 inch diameter copper tubing, 3 inches long.

Our unit worked right off the bat, the first time voltage was applied, but it was necessary to reposition the input coupling and cathode tap (either side of center on schematic diagram number L2), adjusting both for the lowest noise figure. *The lowest noise figure and greatest gain probably will not occur in the same position on the tap, and it IS very critical.* Cut and try is our best advise.

KLYD TROPO SCATTER REPORT

(Continued from page 7)

NO SIGN OF KBAK-29

KBAK, also Bakersfield, operating from a very similar antenna site only a mile from KLYD, produces no sign of a consistent signal. KBAK however operates with only 20 kw visual power. Calculated power ratios would explain nearly 8 db in difference between the two signals. Under tropospheric inversion conditions when both signals are viewable, the signal difference proves to be very close to this 8 db calculation.

A SUMMER AHEAD!

The Parabola will be 65 feet in the air before this is read and our experimental 6CM4 amplifier will be tower mounted.

If we can make 200 mile plus UHF reception work over desert terrain, there is no reason why it should not work in the mid west over similar distances if acceptable transmitting powers are used, AND, if suitable receiving equipment is employed. Monthly reports will follow.

DXH IN STORES

Beginning with this issue DXH is available at many additional Electronics Supply Houses in the Rocky Mountain States, and the Pacific Northwest. In the months ahead DXH will expand its store sales program, in conjunction with the increased demand from over the counter buyers at leading Electronic Wholesale houses across the country.

TV Reporting

SUPERB COOPERATION!

With this month's column it should be very evident that the summer period of TV DXing has arrived! And DXer cooperation has been nothing short of fantastic. From operators of Cable Systems who have noted E skip interference (Stephens, Revelstoke, B.C.) to shortwave DXers surprised and delighted to find TV DX really does happen (Derington, Troyer, Sacramento, California) . . . and from the old and new recruits to TV DXing . . . cooperation has been the best ever. And such cooperation helps our hobby grow. Enthusiasts will tend to infect neighbors and friends with "TV DX-itis," and our ranks will swell!

Just a reminder. We must have completed report forms. Show the date of reception, channel and station location, and station received. Then (of importance) the first time (in eastern standard time) you logged the DX station, and the last time you actually noted it still coming in. The signal report columns (A and V) should be filled in with standard very poor to excellent markings, grading the received audio and video. Send completed report forms to DXH by deadline time (July 16 for August issue) and we are in business! We supply report forms, incidentally, free of charge.

Now, let's join the rotor jockeys for a look see at what the TV signals have been doing in the past 30 days.

All reports are in EST. Check the active dates against your own logs . . . see how you fared with the rest of the DX clan.

May 15 — A big E skip date east of the Rockies. E skip from Wisc. to Texas (1200), N.Y. to Okla., Kansas (1030-1200), N.Y. to Col. (1800). Ill. to Utah, Col. (1230-1430), Fla to Minn., Iowa, Ill., Wisc., Quebec (0915-1145). Ohio (Parillo) to Tex., Miss., La. (0855-1145), Kansas, Col. (2055-2105). Michigan (Navarre) to Alabama (1125-1145). Ohio (Emmons) to Tex., Kansas, Col., Wyo., (1035-1320), to Col., Kansas, (2000-2045), to Wyo. (2200-2205). Ill. (Pagel) to Utah (1325). On the opposite end of the foray, Colorado (Himes) to Ohio, Tenn., La., Ill., Wisc., Ga., Fla., N.C., Miss., Va., Ind., (0745-1130). To N.Y., Ontario (2030-2215).

May 16 — 200 mile UHF tropes over mid west 0530-0600. Over water tropes from Florida to S.C., Ga., N.C., La. (Ruland, Holly Hill to KALB—680 miles), Ark. (KATV-7, 720 miles), in the pre-dawn, and dusk hours. UHF tropes from W.N.Y. to Binghamton (1530), and in the 200 mile range over Illinois, Indiana. E SKIP Illinois (Eckberg) to NYC, Conn. (1200-1245). Colorado to S.C. (1230-1300), to Idaho (0915-1105).

May 17—500 mile tropes over the Southeast U.S.A. (Fla., Miss., Ala., N.C., S.C.), A.M. and P.M. hours. E skip British Columbia to Nev. (1240-1330). Colorado to Ontario (1415-1500), to Tenn. (1530-1535). Wisc. to Texas (1600). Ohio to Okla. (1625-1635). Fla. to Texas (1639-1735). Arizona to Ala., Mexico, B.C., Canada, Wash. (1755-0105 on the 18th).

May 18 — More early morning TROPS over the southeastern U.S.A., with Donald Ruland (Holly Hill, Fla.) receiving WISH-8, Indianapolis, 785



Entering his fourth active DX season, this rising young southern DXer is Donald Ruland, Holly Hill, Florida. Don has logged 165 VHF stations (155 verified) from 32 states, Dist. of Columbia, 4 Canadian Provinces and 8 countries.

miles from 0710-0720. Pagel, Illinois, Kanaar, Buffalo, N.Y. report UHF to 300 miles over the Great Lakes in the early morning hours. E SKIP Wisconsin to Tex., Col. (1600). David Beal, Phoenix reports E skip to Ala., Miss., Fla., La. (2030-2230).

May 19 — Again . . . early morning tropes to 500 miles on high and low band VHF over S.E. U.S.A. Again, UHF to 250 miles 0500-0700, Great Lakes area. E SKIP a very active day. Wisc., Ill., report reception from Nova Scotia, N.B., Canada, 1555-1610. Owen, Ohio reports Mass. 1520-1540. In the evening, Beal, Arizona reports Mo., Mont., Wash., Idaho, Iowa (2030-0010). Hauser, Okla. reports Utah (2210-2345). British Columbia DXers report California low band signals (2300-0200). Central California DXer Escue reports N.D., Wash. (2230-0200). Florida received Ontario, Canada (1858-1902). Himes, Col. reports California (2100-2300).

May 20 — More early A.M. (0600-0800 TROPS on high band to 500 miles over the S.E. U.S.A. Also good early morning mid-western TROPS. E SKIP Beal, Arizona reports St. Louis, (2115). Ruland, Fla. reports Texas (0705-0717).

May 21 — 500 mile TROPS to N.C. from Florida in the P.M. David Janowiak, Milwaukee reports 4 Meteor Scatter stations identified between 0700 and 0800 on channel 4, 450-1200 miles. No E skip reported.

May 22 — Long haul tropes over the midwest in the A.M. (KARK-4, 644 miles by Himes, Col. top haul) 0830-1230. More tropes from Ill. to Neb., Mo. to 400 miles (1900-2200). E SKIP apparently only after 1600. Michigan to Texas (1640-1710), Ohio to Cuba (1740-1835), Ill. to Texas (1800-2130), Okla. to Idaho (2145-2300), Col. to Calif. (2200-2315) and Arizona to Wash., Mont., Idaho, Iowa, Oregon (2300-0100).

May 23 — Tropes 0000-0100, Ill. to Neb., S.D. (Eckberg). A.M. and P.M., Fla. to N.C., 500 miles. E SKIP Indiana (Ehresman) to Texas (1845-2135).

May 24 — Northern Lights, Wisc., Pa., 0045-0055, 0530-0645. More P.M. TROPS to N.C. (500 miles) from Ruland, Holly Hill, Fla. E SKIP Owen, Ohio reports Texas (0910-1145). Draeb,

Wisc. reports Texas (1335-1500). Colorado reports Ga., N.C. (0915-1000), S.C., Tenn., Fla., Ohio, Pa., Ont., Canada (1000-1530). Fla. reports Iowa (1900-2130), Ont., Wisc. (2045-2230). Wisc. reports Quebec, Canada (2206-2300). Ind. reports Ala., Fla. (1800-2140). Calif. reports British Columbia (2230-2245).

May 25 — 0600-0800, TROPS to 500 miles, S.E. U.S.A. 1900, high band tropics to 500 miles, Fla. to N.C. E SKIP 0011-0130, Wisc. to Colorado.

May 26 — More 500 mile tropics to N.C. from Florida (1900). E SKIP Virginia to Michigan (time unk.), Berg reporting. Arizona to N. Calif. (2325-2345).

May 27 — E SKIP Maryland, N.C. low banders seen by Ross, Newfoundland, Canada (1100-1300).

May 28 — TROPS Florida to N.C. 500 miles, (2230-2330).

May 29 — 0752-0815, TROPS Florida to Va. (WXEX—600 miles), Ruland. E SKIP British Columbia to California, S.D., XEM (Mexicali) from 1100-1600 by Stephens, Revelstoke.

May 30 — Morning TROPS, Mo. to Ill. (350 miles) Bingham, Fla. to N.C. (0615-0730) 500 miles. Morning-Noon E SKIP session. Mo. to S.C. (0900). Va. (Collier reporting) to Tex., La. (1055-1320). Ohio to Fla., Cuba, Texas (1230-1310). Wisc. to Texas (1230-1400). Mo. to Idaho (1300). Ill. to La. (1300-1330). Okla. to S.C. (1358-1427). Ill. to Texas (1340-1500). Fla. to Iowa, Wisc. (1100-1315). Calif. to Wyo., S.D. (1640-1757).

May 31 — TROPS Okla. to Wisc. (1400-1700). E SKIP Col. to Idaho, Wash., Alberta, Canada (1345-1845). B.C., Canada to Calif. (1400-1830). Ind. to Tex. (1830-1845). Mo. to Mexico, Arizona (1900). Mch. to Mont. (1900-1905). Col. to Alabama (2130-2145).

June 1 — Great Lakes TROPS (Navarre, Detroit) to 210 miles, 0800-0900. Calif. TROPS to Calif. 250 miles.

June 2 — TROPS, Wisc. to Ill., Mo. 450 miles. UHF TROPS, Calif. Central Valley to 220 miles (2300-0000).

June 3 — TROPS Seybold, N.Y. reports Ky., Great Lake states to 400 miles. E SKIP Colorado (Himes) reports N.Y. on long single Es 0930-1000, Texas, Mexico, (1030-1045). Wisc. saw New Brunswick, 1048-1120 (Draeb). Ill. (Pagel) to Alabama (1930-2300).

June 4 — TROPS Missouri to Ohio (Bingham reporting) to 490 miles, 0900.

June 5 — Midwest TROPS, A.M. and P.M. to 400 miles (Mo., Tenn., Kansas, Okla.) E SKIP Modesto, Calif. to Texas (2230-0000).

June 6 — A.M. TROPS to Mich. from Mo. 480 miles. E SKIP Arizona to Mo., Okla. (0900-1000). Col. to N.C. (0930-1200), Tenn. (1300-1330), Florida (1500-1545). Arizona to Idaho, Oregon, N. Calif. (2345-0030).

June 7 — UHF from Toronto to S. N.Y. 200 miles (0900-1000). E SKIP Arizona to Tex. (0915-1000), Mo. to Cuba (1100). Michigan to Maine (1840). Okla. to Wisc. (2007-2040). Mo. to Idaho (2200).

June 8 — A.M. TROPS in the Midwest. E SKIP S. Calif. to Okla., Texas, Kansas 1055-1420 (Smith, Calif.) Okla. to Md., S.C. (1220-1430). Modesto, Calif. to Texas (1100-1200). Arizona to Oregon, N. Calif. (2130-2250). AUORAL Es (1700-1900) Navarre, Detroit reports Canadians on channel 5-6. Any other Auroral reports for this night?

June 9 — A.M. TROPS, Mo. to W. Va. (580 miles) Bingham, Festus to WTRF-7. E SKIP Col. to Mexico, Texas (1330-1445, 2000-2115). Okla. to Utah, Wyo. (1500-1600), Nevada (2045-2135). Arizona (Beal, Tucson) to Mo., Kansas, Ill., Okla., Texas (2100-2315).

June 10 — TROPS Mo. to Cleveland, W. Va., 600 miles (0200). E SKIP S. Calif. to W. Texas (1005-1105), N. Calif. to Texas (1135-1205).

June 11 — Good meteor scatter reported 0530-0830. E SKIP Okla. to Wyo., Idaho (1211-1300). S. Calif. to Mont., Alberta, Canada (1400-1615). Modesto, Calif., to Mont., Texas, Kansas, Sask., Canada (1226-1440). Arizona to Sask., B.C., Canada and Wash. (1415-1530).

June 12 — Arizona to N. Calif. (0005-0025), Wash. (1500-1550). Modesto, Calif. to Sask., Canada, (0010-0040). N.J. to Fla. 1825-1835 (Foxworth) Ill. to Fla. (1730-2000).

June 13 — 300 mile TROPS over Mo., Iowa, Neb. E SKIP Okla. to Fla. (1059), Ala. (1230). Arizona to Neb., Mont., Wash. (1320-1525). Ill. to Texas (Pagel) 1639. Modesto, Calif. to W. Texas (1135-1205).

June 14 — E SKIP Modesto, Calif. to Kansas (2330-0000).

June 15 — E SKIP Arizona to N. Calif., Okla., La., Mo., Ala., Tenn., (1330-1830).

LATE REPORTS AND SUMMARY

Bill Hauser, Oklahoma City notes Es June 16 to Montana (1400), S.C. (1700), Sask., Canada and N.D. (2000). On the 18th, DXH caught a good E skip opening to Washington, Mont., Alberta and Sask., Canada and Texas from 1400-1935.

Generally speaking, E skip has not lived up to earlier expectations. Some VHF experts feel July will be "the one big month," pointing to 1955 as an example. Others feel the year just was not cut out to be a big one in the first place. Certainly Gulf Area tropics are being exploited as never before by Don Ruland of Holly Hill (suburb of Daytona Beach), Florida. Other Gulf and S.E. U.S.A. DXers report nothing too unusual when Don is catching DX . . . attesting to his new Winegard Super Ceptor antenna and a '60 model fringe Zenith receiver ("Franklin D2430" model). Don's near consistency with 400-500 mile high and low band VHF should be duplicated by any well set up DXer of the S.E. U.S.A.

DX PREDICTIONS (June 30—August 10)

No one reported any signs of meteor burst daytime DX on June 4-6, or 8, but then perhaps nobody was trying. Certainly the showers occurred. This month meteor activity will be on the waning side except for the latter portion of the report period. The yearly recurring Perseids Meteor Shower of course peaks August 12-14, with significant meteor activity starting as early as August 1. As this is usually the biggest shower of the year all DXers are alerted to pay particular attention to both the low and high bands. The low band channels (2-6) should produce good bursts from August 1 through the 15th. DXers with sensitive high band equipment will do best to check August 12-14. The shower runs almost all day long with peaks between 2330 Local standard time and 1130 LST. The hours just prior to and during daybreak will produce excellent results. Standard meteor burst procedures should be used.

(Continued on page 19)

FM Reporting

Edited and prepared by BRUCE ELVING
522 North 121 $\frac{1}{2}$ Avenue East
Duluth 5, Minnesota

While FM Editor Bruce Elving is in transit between his winter teaching chores in Kansas and his home in Minnesota, this month's FM column will be devoted to a report on tests conducted with an FM Converter for the car. Editor Elving's column will return in August.

The Gonset FM Car Converter and Halo Antenna

For the technical minded we refer you to RADIO-ELECTRONICS Magazine, August, 1959, Page 55, for an excellent engineering analysis of this unit.

For those desirous of an operation review, read on!

Very briefly, the Gonset Model 3311 FM Auto Converter is a 7-tube FM to AM Converter using hybrid tubes and some fairly unique circuitry.

The fairly low noise front end ("roughly measured" at DXH as 5.5 db) uses the triode half of a 12EC8 in grounded grid fashion. The pentode half of the 12EC8 operates as a cascade RF stage, feeding the 88-108 megacycle signal to a second 12EC8 mixer. Also fed to the mixer is the AFC controlled oscillator output. Output from the mixer is 10.7 mc, which flows through an I.F. transformer to the I.F. amplifier tube, a 12EZ6.

In mobile reception of any VHF signal, outside noise from the car's ignition system, other cars, power lines, etc. can be the limiting factor to reception. The Gonset Model 3311 solves the noise problem with a cascade limiter circuit using a pair of 12EZ6s. It is very effective, as we shall point out shortly.

The 10.7 mc signal is further lowered to an 800 kc output frequency through a "translator tube," a 12AD6.

INSTALLATION

Very simple, as with all Gonset Mobile units we have tried to date. A "U" brace bolts to the unit, "hanging it" under the dash. The AM antenna is pulled from the AM radio input, and plugged into the FM Converter input. The FM Converter output (fitted with standard "phono jack connector") plugs into the AM radio antenna input. A red alligator clip lead connects to the 12 volt B voltage on the ignition accessory switch. "Tune car radio to 800 kc, switch on the Model 3311, and tune the dial for FM reception."

The unit is a "tunable Converter," which means you tune the Converter, not the AM radio.

HALO ANTENNA

The Halo antenna shown is mounted as a "sleeve" over the existing "partially extended" AM BC antenna. On AM it actually improved reception (don't ask us why!). On FM it brought hissing stations in noise free, and brought unheard stations in with listenable quality. It is horizontally polarized, making it compatible with the FM signals (as opposed to the vertical car whip). There are no electrical connections . . . it merely slips over the existing antenna, and is tightened into place with a single allen set screw.



Model 3311

PERFORMANCE — Converter and Antenna

The Converter cannot be expected to compete with ultra low noise ECC88 front end home station tuners. But it does provide consistent mobile reception from stations up to 125 miles away, while their AM outlets are buried in power line noise and co-channel interference. The noise rejection characteristics of the unit are particularly noteworthy. Auto ignitions, power lines, and even neon lights failed to penetrate its cascaded 12EZ6 limiters in our 45 day test run. Direct comparisons between the Halo antenna and the vertical whip showed a 12-15 db improvement in favor of the Halo.



Halo FM Antenna

DX RECEPTION

The sensitivity of the Converter-Halo combination was proved two nights in mid-May when reception from a pair of FM stations in Kansas and Nebraska were noted under E skip conditions.

PRICE . . . WHO TO CONTACT

Halo antenna lists for \$9.95, net unknown (a fine omnidirectional antenna, incidentally, for permanent installations in suburban areas). The Model 3311 Converter lists for \$79.50, net unknown. In either case contact your Gonset Distributor, or Gonset direct at "Gonset Division," 801 South Main Street, Burbank, California.

FM/Q

ANTENNAE SYSTEMS

GET MORE FM STATIONS WITH THE WORLD'S MOST POWERFUL FM BROADBAND ANTENNAE

To be fully informed, send 30¢ for NEW Edition of "All About FM Antennae and Their Installations" by L.F.B. Carini. Contains Directory of FM Stations and Log.



FM/Q WETHERSFIELD 9, CONN.

WINEGARD TC YAGIS

(Continued from page 12)

With the CL4, the maximum viewable VHF distance on a day-in day-out basis was 205 miles on VHF. Now, with the TC series, low band VHF can be watched (co-channel interference permitting) to 265 miles, and high band VHF to 240 miles. The high band station (KVIP-7, Redding) is but 70 degrees off of a local channel 7 station KGO—San Francisco) only 80 miles away, and yet it can be brought through the 1200 mu signal from KGO!

FRONT TO BACK RATIO

In our location DX work comes from the East primarily, and the north secondarily. Our local viewing fare is primarily from the north, and west with a sprinkling to the south. To the east we have the Sierra Nevada mountain range, within eyesight from the top of the antenna mast, about six degrees above the horizon.

With the main local viewing fare (on the low band) from the west and DX mainly from the east, the front to back ratio of our antenna system is very important. The following chart gives the relative field strength voltages on each low band channel at three different points; main lobe on the station, 90 degrees off the station (side of antenna) and at the back of the antenna.

TC SERIES YAGIS FRONT TO BACK, FRONT TO SIDE RATIOS (m/v per meter)			
Channel	Main lobe	90 degrees	back
2	420	20	60
3	600	30	85
4	675	20	150
5	525	20	50
6	1100	45	150
7	1200	20	50
8	3800	70	150
9	1400	25	50
10	2500	100	250 (saturation)
11	275	00	20
12	550	30	75
13	5000	500	1250 (saturation)

Chart Two

WRAP UP

The antennas look good in the air (important wife consideration!), are ruggedly built for an assembly line product, are easily assembled and quickly mounted. They react well to wind and weather. On the performance side their gain is greater than any all low channel, or (especially) all high channel array we have compared directly or indirectly. And for the DXer it would appear to be a natural step upward from his current all channel yagi of lower gain and poorer all around qualities. The use of separate antennas for high and low band work (with separate transmission lines) has not been found to be more than a minor irritation, when the advantages are considered.

FULL INFORMATION

Can be obtained from the manufacturer by writing the Sales Department, Winegard Company, 3000 Scotten Blvd., Burlington, Iowa.

TV REPORTING

(Continued from page 17)

E SKIP

The current reporting period breaks down into four separate forms of E skip openings, each progressively less active than its successor.

July 1-12 — This period, coupled with late June, is the season's best. Any hourly breakdown in predictions would serve no useful purpose, although there will be a definite trend towards more evening openings (1600-2000 LST).

July 13-23 — By this period of July, DX openings have thinned out considerably. Openings occurring are for the most part between 1100-1330 LST, and 1630-2100 LST.

July 24-31 — Morning openings will diminish nearly entirely by this period, and DXers will do well to concentrate on the noon and late afternoon periods for E skip. Long single hop with fairly steady signals will also develop during this period, giving DXers a shot at low banders 1300-1600 miles distant.

August 1-10 — With the frequency of E skip reception on the wane, the bulk of the activity shifts now to early evening openings, with late afternoon playing a close second. Most openings bring reception from only a handful of stations, or at worst, a single station. Signals are weak and full of slow ghost fading.

TROPOSPHERIC DX

In the earliest parts of the month ground wave DX will favor the upper midwest and the Great Lakes region. Actually the entire period favors ground wave DX in this region. Atlantic Coast-line DXers should begin to get their licks as July turns to August. Early morning and late evening hours continue to be best for ground wave in the 200 mile and up range, high and low bands.

FREE MAGAZINES — AROUND THE WORLD!

DXing Horizons continues to receive numerous requests each month for sample copy magazines from TV, FM and Shortwave enthusiasts who have heard about DXH "over the air," through the printed word, and by word of mouth. Because the response to this policy has been so "impactive" we will continue to supply magazines. Send the name(s) and addresses of enthusiasts you think would be interested in receiving a sample copy of DXH to "Sample Magazines," P. O. Box 3150, Modesto, California.

SHORTWAVE DXers — ATTENTION

Mark down July 16 and 17 down on your calendar for the July edition of the DXH Shortwave newscast. On the 16th, shortwave station WRUL will beam our cast to Europe and Africa on frequencies of 15.380, 17.750, and 21.460 at 2100 GMT. On the 17th, South American and South Pacific DXers will be able to hear the latest DX news on frequencies of 11.830, 15.380 and 17.755 at 2345 GMT. Let us hear from you!

SHORTWAVE STATION REPORT

DXing Horizons Salutes . . .

"Democracy's Mouthpiece"—VOA

"The U.S. Information Agency's broadcast arm in the future will use something communist countries understand best: that's power," BROADCASTING magazine reported recently.

"The big stick the Voice of America will wield is kilowatts. And the European, Asian or African who spins his dial won't have to strain his eyes or ears to pick up one of the 100-odd Voice programs broadcast daily in 38 languages. When he dials across a Voice frequency the signal will be coming in so strong he can lean on it."

"This simple and straightforward plan to fight power with power is never far from the thoughts of Voice Director Henry Loomis, who moved into the job in July 1958 with a background completely uncluttered by any experience in broadcasting. Mr. Loomis is youthful (41 on April 19) and enthusiastic and is a physicist who got sidetracked into government research, strategy and intelligence in 1950.

Mr. Loomis is a son of Alfred Lee Loomis, who pioneered in the sonic and electronic fields. In the Navy, the younger Mr. Loomis was largely instrumental in setting up the radar maintenance schooling system; he tutored Admirals and Captains on what radar was all about and how it could be used most effectively in tactics.

BROADCASTING continued: "Mr. Loomis thinks the Voice's Greenville (North Carolina) base will make U.S. international broadcasting impossible to ignore and put the Voice in a more competitive position with the communists in telling what this country has to say with reasonable assurance it will be heard."

The new VOA facility at Greenville will be the largest and most powerful long-range broadcasting station in the world. It is designed to radiate a stronger signal to Europe, Africa, the Middle East, and South America; to provide a flexible relay system to overseas bases and for direct shortwave transmissions to target areas, and to provide an emergency



Henry Loomis returned to the U.S. Information Agency in 1958 as Director of the VOICE OF AMERICA, after having served as Staff Director to Dr. James R. Killian, Jr., Special Assistant to the President for Science and Technology. His earlier service with USIA was as Director of Research and Intelligence. A graduate of Harvard, he was once a research physicist for the Atomic Energy Commission.

communications system. It will take over the communication load now carried by the obsolescent transmitters at Boundbrook and Wayne, New Jersey, and at Brentwood and Schenectady, New York, which SW DXers know as WBOU, WDSI, and WGEO, respectively.

The major transmitting equipment will consist of six 500-kw., six 250-kw., and six 50-kw. transmitters. There also will be smaller transmitters and up-to-date receiving equipment.

The new facility will occupy three sites totaling about 6,100 acres. One transmitter base will be located 15 miles northeast of Greenville, near Pactolus, the other 15 miles southeast of Greenville, near Shelmordine. The third unit—a receiving site—will be 6.5 miles west of Greenville.

BROADCASTING cited that "the 500-kw. transmitters, which cost the U.S. \$2.9 million, were paid for with money appropriated during the 1950-51 Korean War period. But Voice plans at that time to use the six transmitters on the East and West Coasts (Baker East and Baker West) ran afoul of two Senate com-

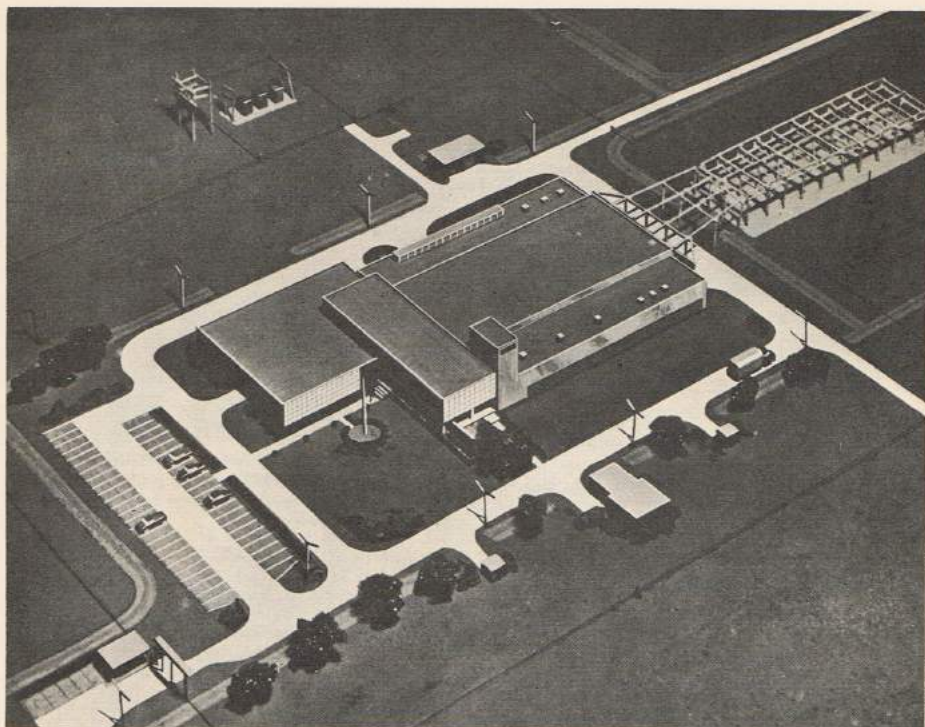

This is a model of one of the transmitting stations to be constructed for the Consolidated East Coast Facilities of the U.S. Information Agency's Voice of America near Greenville, North Carolina.

The 50,000 square foot transmitter building consists of three divisions. The division at the left will house garages, warehouses and shops. The main section at the rear will house the transmitters.

At the rear of the building can be seen part of the framework for the elaborate switching station which will feed the antennas.

mittees which charged waste of money and the equipment has been in warehouses ever since."

As of early June, work in clearing the Greenville sites was "keeping on schedule," according to Erwin van Swol, Office of Public Information, USIA. "Much of the timber has been felled and removed, roads and drainage ditches are under construction, and pre-loading with stone fill of the building and antenna bases has begun," he told DXH.

In August 1959, a 40-year agreement was signed with the Liberian Government to permit construction of a high-powered shortwave relay base in Africa for coverage of Africa and to supplement existing coverage of the Middle East area. For "Project Larry," BROADCASTING said "the Voice plans to install six 250-kw. and two 50-kw. shortwavers."

What about JAMMING of VOA transmissions? Jamming is a type of radio inter-

ference designed not only to block out normal reception, but also to make the listener so annoyed that he will turn off his radio set.

Any type of program can be jammed—SW, MW, or LW. However, jamming can never be completely effective. This blotting out of incoming signals is usually most effective in the metropolitan areas where the jammers are located. This means that while the Soviets jammed President Eisenhower's address to the world on the Summit Meeting in May, it still got through to some of the Voice's audience in the USSR. (The Voice's *English* broadcasts are NOT jammed by the Soviets and *there are an estimated 10 million Russians who understand English.*)

Best wishes go to Director Henry Loomis and the VOICE OF AMERICA in the expansion project to "give the world a clear ear" to "DEMOCRACY'S MOUTHPIECE."

—KEN BOORD

SHORTWAVE PROFILE

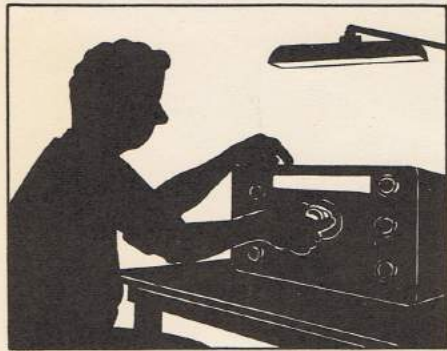

Mr. Anson Boice, New Britain, Conn., U.S.A.
and
Mr. Floyd F. Backus, Richmond, Va., U.S.A.

Anson (Ans) Boice, 93 Whiting St., New Britain, Conn., first became interested in SW radio back in 1929, when he built a 2-tube rx on a breadboard—the design of which was featured in the ARRL Handbook of that year. Ans has been an active SWL in most of the years since 1929.

The first station he picked up on that little, battery-operated rx was PCJ ("Pearce, Cheer, Joy"), then owned and operated by Philips Laboratories and located at Eindhoven, Holland. "Lo and behold! The anncer on that day in March 1929 was no other than the one and only, our good friend, Eddie Startz, now of 'Happy Station' fame," says Ans. "Being of Dutch descent, this, of course, has made me an ardent fan of PCJ, now Radio Nederland at Hilversum."

Ans is a contributor to DXing HORIZONS, Popular Electronics, the Newark News Radio Club, and "Sweden Calling DX'ers." He is State Director for NNRC, is a monitor for Radio Japan, and is a member of the BBC Listeners Panel.

Down through the years, Ans has used such rx/s as HALLICRAFTERS S-22-R, SX-28, and SX-43 and a RME-DB22A preselector. At present, he is using a HAMMARLUND HQ-100, a Grundig Majestic 3090-WF-3D, along with a Webcor-Regent (three-speed) tape recorder. His main antenna is an 8' vertical approximately 30' in the air, plus several indoor antennas.

"It was only about 12 or 14 years ago that I seriously started to collect verifications," says Ans. "Now I have heard 100 countries with 83 verified and several reports are now out. My two best veries are YDE, Batavia, Java, now Djakarta, Indonesia, running 500 watts on 15.150, heard May 30, 1948, and CR6RA, Radio Clube de Angola, running 250 watts on 7.142, heard December 19, 1951. My listening and veries are strictly for SWBC stations."

Of himself and his family, Ans says: "I am 46 years of age; XYL Julia is slightly younger! We have six children—three boys and three girls—the oldest is 21 and the youngest is 10." (And a fine family this is, believe me; I had a most pleasant visit with the Boices a few years ago!—Ed.)



The SWBC experience of Anson (Ans) Boice, Connecticut, U.S.A., dates back to 1929 when he got his first SW thrill in logging PCJ, Holland, on his home-built 2-tube, battery-operated "breadboard" rx.

* * *

DXH is happy to salute a second U.S.A. SWL this month—Floyd F. Backus, 2906 Dellrose Ave., Richmond 28, Virginia. Floyd's FB SW Listening Post is well-equipped with a NATIONAL NC-183, a NATIONAL NC-188, a HALLICRAFTERS SX-71, and a RME-45. He also uses a RME-DB22 preselector and a "Q" Multiplier, "both of which prove very useful," he comments.

"I have veries from more than 200 countries; I've stopped counting, but my most-prized cards are those from Lebanon, Afghanistan, Taiwan (Formosa), R. Vietnam (3WT), BBCFES (Singapore), and India."

Floyd is a member of several leading radio clubs and contributes widely also to several publications—including DXH.—KEN BOARD



Floyd F. Backus, Virginia, USA, is justly proud of his fine SW Listening Post, which is well-equipped with a NATIONAL NC-183, a NATIONAL NC-188, a HALLICRAFTERS SX-71, and a RME-45. He also uses a RME-DB22A preselector and a "Q" Multiplier, "both of which prove very useful," he says.

SWL'g is a National Pastime . . .

IN THE LAND OF THE MIDNIGHT SUN

By
Sven Elfving, Solgardsgatan 15,
Ornskoldsvik, SWEDEN

With
Ken Board, DXH SW Editor

(Part two of three)

Most of the stations which operate on short-wave — particularly those that operate an OVERSEAS SERVICE—do appreciate reports because they can find out on what frequency or frequencies they are heard BEST, WHAT PART of the world receives their various transmissions BEST, and AT WHAT TIME the BEST reception is achieved — together with other essential information that is of interest and helpfulness to their engineering personnel.

With my reports to ISWBC stations, I send along a mimeographed letter which cites many of the facts I have just related—about my location, my receiving equipment, the popularity of SWL'g here in Sweden, and so on. I believe this has helped me a great deal in securing much-desired QSLs.

MIMEOGRAPHED LETTER

The mimeographed letter which accompanies each of my reports to SW broadcasters concludes in this fashion:

"It would, therefore, be a very great pleasure for me to receive a verification from your station, any kind is appreciated, the main thing is that you confirm that my report is correct, on what frequency I listened, and on what date the report was taken. If you want further reports from me, just let me know. It will be a pleasure for me to give you monthly reports on any frequency. If I can be of any further help, I will be very pleased and if you have any request, tell me, and I will surely try to help you.

"I wish you good luck from Sweden, the Land of the Midnight Sun, and I hope you will take the trouble and send me a verification letter or card on the enclosed report. Thanks again for good and interesting programs and best of regards from Your Very True Radio-Friend and Listener in Sweden."

WHAT DO WE HEAR?

To what stations do we listen on the ISWBC bands here in Sweden?

To begin with, AFRICA is a very popular

Your station was heard on the _____ of _____ 19____	on _____ kc's _____ meters
from _____ to _____ G. M. T.	QSA _____ QRK _____ and _____
Details from Your transmission:	At _____ GMT
At _____ GMT	At _____ GMT
At _____ GMT	At _____ GMT
At _____ GMT	At _____ GMT
Receiver _____	tube set made year _____
Antenna: outdoor/indoor _____	meters. Weather _____
Thanks very much for Your transmission. Please check this report with the log and if it is correct please send me Your verification.	
Name _____	
Address _____	

This is the report-card used by members of the POLAR BEARS RADIO CLUB at Ornskoldsvik, Sweden. This club is headed by Sven Elfving, one of Scandinavia's top-notch young SW DXers.

section of the world for SWLs in Sweden as well as elsewhere.

In ANGOLA, for instance, there are many "small" radio club stations which are active; these can be heard here when conditions are good. CR6RN, 4.869, Radio Clube de Angola, and CR6RZ, 4.955, Radio Angola, are the strongest Angolans here in Ornskoldsvik. CR6RF, Radio Clube de Benguela, is also a "rare" station here; it can be heard on 5.042 AND 9.502. Other Angolans logged include CR6RG, Radio Diamang, 4.770, Dundo, 1 kw.; CR6RQ, Radio Clube de Huambo, 4.851, Nova Lisboa, same power; CR6RH, Radio Clube de Huila, 5.024, Sa da Bandeira, with 400 watts; CR6AA, Radiodifusora Lobito, 5.033, another 1-kw.-er and, lately, CR6RW, 5.055, Cabinda, listed in WRH60 with 1-0.25 kw. All of these relatively low-powered stations feature much excellent dance music, and varied excellent programs in Portuguese.

ZNF, Fafeking, BECHUANALAND, is indeed "a very rare and hard-to-get" station, operating on 5,900 with only 220 watts (WRH60 says 1 kw.). It can be heard here in Sweden sometimes around 1800 GMT when signals from Africa are often rather good—but it always seems to suffer from heavy QRM!

The BELGIAN CONGO station, OTM1, 6.295A, Leopoldville, 250 watts, also can be heard around the same time. The other Radio Congo Belge transmitters on 4.757 and 9.380 are heard with excellent signals all "evening" (GMT).

KENYA has several challenging shortwave stations on various bands—particularly in the lower frequencies. My "best catch" here was the Nyeri (Mau-Mau) station on 6.170 (now INACTIVE); my reception report to this one was verified as the "first one from overseas." Kenya outlets can be heard on 4.965 and 4.804

with 500-watt transmitters—but the *strongest* channels from this African country are those which operate on 4.934 and 4.885 from Nairobi—with wonderful S5-9 signals all “evening” (GMT) here.

From MOZAMBIQUE, Radio Pax, 3.952, Beira, is logged although the power is *only* 375 watts. Radio Clube de Beira, 7.255, 3.255, is heard with good signals; the power is 300 watts.

Lagos, NIGERIA, 4.990, as well as the RHODESIAN stations on 4.826, 4.911, and 6.018 are logged at 1800.

Among the “*best*” stations logged from the FAR EAST, I must mention the Indonesian “*domestic*” (RRI) transmitters. On 120 meters, YDA2, 2.420, Bandung, 240 watts, and YDA6, 2.890, Tjirebon, 150 watts, are the *BEST*.

PACIFIC GOLD MINE

The PACIFIC AREA is a *literal* “*gold mine*” for European listeners:

Stations of the AUSTRALIAN Domestic Shortwave Service (ABC) are often heard—although the powers are *only* 2, 5, or 10 kw.

VL76, 6.130, Pt. Moresby (BRT.) NEW GUINEA (PAPUA); VLM4, 4.920, Brisbane, QUEENSLAND, and VLX4, 4.897 (now *REPLACED* by VLX15, 15.425), Perth, WESTERN AUSTRALIA, are not heard so often.

COOK ISLANDS was heard *once* on 5.050 over ZK1ZA, Radio Rarotonga. (WRH60 lists this one on 4.965, running 350 watts.)

FIJI ISLANDS can be heard in the 75-meter band over VRH4, 3.980, Suva, running *only* 500 watts!

VSZ10, Tarawa, GILBERT AND ELLICE ISLANDS, listed in WRH60 with *only* 100 watts, was *logged once and was verified*.

Radio NEW ZEALAND, Wellington, has been heard here on several channels, including ZL2, 9.540, and ZL7, 6.080, at 0800-1130A; ZL3, 11.780, at 0800-0900 with good signal level, but *strongest* has been ZL4, 15.280, at sign-on 1850 and again at 0300 when it often has been “*just like a LOCAL station*”!

To date, however, my “*best catch*” in the Pacific Area has been VQO2, Honiara, (BRT.) SOLOMON ISLANDS, heard on 5.960, *when the power was only about 90 watts* (now 5 kw., heard during December-February almost every day).

Radio TAHITI, Papeete, is heard on 6.135 to 0730; power is 4 kw.

NORTH AMERICA

In NORTH AMERICA, a few “*rare*” CANADIANS have been logged on short-

wave. The “*best*” one for me has been CKFX, 6.080, broadcasting from Vancouver, BRITISH COLUMBIA; the power is *only* 10 watts! CFVP, 6.030, Calgary, and VE9AI, 9.540 (*now believed off the air*), Edmonton, both in ALBERTA, have been heard quite often; each is listed with *only* 100 watts!

In CENTRAL and SOUTH AMERICA, many “*rare*” stations have been logged and reported, but it is *difficult to get veries from these broadcasters since, unfortunately they do not seem to understand the value of a reception report!* (Here’s a tip for what it’s worth: REPORTS TO SPANISH-SPEAKING STATIONS OF LATIN AMERICA HAVE A BETTER CHANCE OF BRINGING YOU A QSL IF YOU WILL REPORT TO THEM IN SPANISH!) *Many low-powered stations have been logged from COSTA RICA, CUBA, the DOMINICAN REPUBLIC, and HAITI. In HAITI, the “best” station has been 4VWA, 6.155, Cap Haitien, Radio Citadelle, using only 150 watts.*

RARE PROPAGATION

At my QTH here in northern Sweden this past winter, I was able to log some quite outstanding LATIN AMERICAN signals for a European listener. During January, for example, I logged SOUTH, CENTRAL, and NORTH AMERICAN stations when they *opened* around 0900-1000 GMT! This is considered *quite unusual* for a European listener—and some of my SWL friends in the southern part of Sweden and in other parts of northern Europe didn’t believe my reports! *But I had some very fine tape recordings which prove that I heard them all right!* Among those logged were CHNX, 6.130, Halifax, NOVA SCOTIA, and CFRX, 6.070, Toronto, ONTARIO, CANADA, both at 1000; HI4T, “*La Voz Dominicana*,” 5.970, Ciudad Trujillo, DOMINICAN REPUBLIC, was S9+ — “*just like a LOCAL station*” when opening at 1000 (*heard every day when they put their carrier on also!*); 4VB, Radio Commerce, 5.985, Port-au-Prince, HAITI, also was heard—as well as Radio Martinique, 5.995, Fort-de-France, MARTINIQUE, starting at 1015; 4VEC, 6.002A, Cap Haitien, HAITI, with *only* 400 watts was heard several times *opening* around 0945 with good signals! *All these “catches” are very “rare” and unusual for European listeners—and, I believe, it is due largely to the fact that I live in the northernmost part of Sweden that I can hear them quite well here in Ornskoldsvik.*

(End part two)

THE WORLD

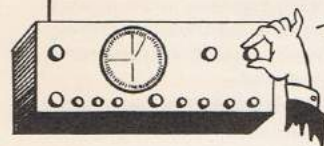

AT A TWIRL

Edited by DXing Horizons Shortwave Editor
Ken Boord
948 Stewartstown Road
Morgantown, West Virginia, U.S.A.

When international radio station KFRN, Dallas, Texas, takes to the airwaves early this fall, its programming will reflect the culture and integrity of the United States to listeners in South America in particular—but its powerful 50-kw. voice should be heard around the world. High-gain antennas will be employed to greatly increase the signal strength. KFRN will operate on 15.180 at 2200-0400 GMT daily. It will beam towards South America.

Programming—in both English and Spanish—will be designed to promote good will and harmony between the peoples of South America and the people of the United States, according to Albert L. Crain (W5SXT), President of the GLOBAL BROADCASTING COMPANY, 2663 Springvale Lane, Dallas 34, Texas, U.S.A.

This private commercial SW broadcaster will present a well-balanced variety of programs of educational material, news, narratives, religious programs, entertainment, discussions, and interviews. *The emphasis will be on education.*

The station will coordinate its program schedule with that of the *Voice of America*, insofar as practicable, Mr. Crain says. A proportionate amount of time will be allocated for commercial and sponsored broadcasts. Programs in the news category are planned to be obtained from the VOA news circuits, commercial wire services and, possibly, from network facilities.

"It will be this station's policy to place special emphasis upon programs that are of an educational nature," Mr. Crain explains. "News programs will be factual in nature. These programs, along with appropriate entertainment and special events broadcasts, will



Al Crain (W5SXT), President of the GLOBAL BROADCASTING COMPANY, reports, "when KFRN goes on the air early this fall on 15.180 at 2200-0400 GMT DAILY, with 50 kw., beamed towards South America, its programs in ENGLISH and Spanish may be heard around the world."

be designed and presented with the objective of best serving the public interest convenience, and necessity.

"Never in our lifetime has public interest and concern been so high in the matter of friendship, understanding, and goodwill between the United States and the Latin American countries. This is most important to our country. The Latin American people want to know more about us and our way of life, our culture, music, and sports. And information can be presented to them by radio more effectively than in any other way because of common and mutual interest in these things," Mr. Crain continues.

"Also, Latin America wants to know how to develop its vast natural resources to bring

a better standard of living to its two hundred million people. Latin Americans are anxious to learn more of our ways of industrial and agricultural development. They want to know about our achievements, inasmuch as they can apply so many things to their own situation to meet their needs.

"On the other hand, the people of the United States are deeply concerned as to how we can help these nations. There is a great interest in the exchange of ideas, and ideals of this country and those of Latin America, which is shown unmistakably by student exchange programs, increased travel between these countries and ours, and greatly accelerated commercial development. There is no better way to get our message to these people than by radio.

"Further evidence of the commercial and economic interest is substantiated by special editions of LIFE Magazine, Reader's Digest, TIME, and others—all of which are supported by American industries which desire to get their message to these Latin American countries. They will use radio as it becomes available to them.

"There are those today who are using radio to distort the facts and to slander the American way of life before the Latin American people. These messengers are dedicated to our destruction by any means possible. This dedication is well known and, in our opinion, will continue. This is in spite of recent overtures of friendship. *It has therefore become urgent, and it is a national interest and public concern that this country be represented by independent radio to other countries in the true light our American way of life deserves which this station will endeavor to do through the universal language of music, sports, news, education, culture, exchange of ideas and information of mutual interest.*"

Among the features planned for the two ENGLISH segments of KFRN DAILY broadcasts will be Musical Salutes (to individual Latin American countries); world news headlines; ENGLISH MADE EASY; Musical Mailbag (request songs, *live and recorded*); Music For You (with inspirational greetings in Spanish and ENGLISH); news of the Americas (achievements of this country and other North and South American countries); *Amateurs Calling* (a discussion with radio amateurs who make frequent contacts with Latin American countries, moderated by W5SXT); Late Evening Music; world news; The Language of Music; Science in the News; The Hour of

Decision (Billy Graham); Oral Roberts Program (music and sermon); The Bible on Record (recording of the Bible played from the Audio Book); Back to the Bible, and other features. There will be a program synopsis at the beginning of each segment, and a preview of outstanding programs for the following day will be given prior to sign-off of the second daily ENGLISH segment.

Programs in Spanish will be quite similar.

"Already, many interesting letters have been received by us from various parts of the world," Mr. Crain concludes. "There seems to be an agreement among them that, since we have a clear frequency on 15.180, we will be heard in most parts of the world. This, of course, is substantiated also by the fact that we will be running a power output of 50 kw. We will send verification cards postpaid."

The staff of DXing Horizons wishes W5SXT and his associates the very best of everything as KFRN endeavors to promote friendship, understanding, goodwill, and trade between this country and those nations "South of the Border"!

AT FADE-OUT

CLUB NOTES—U.S.A.—Through circumstances beyond its control, the UNIVERSAL RADIO DX CLUB will be unable to resume bulletins until Sept. 1. (Stanbury, Ont., Canada, SW Ed., UNIVERSALITE) Stewart C. West, Union, N. J., has been appointed Presidential Assistant of the NEWARK NEWS RADIO CLUB; he will continue to compile and edit the popular Band Survey feature of NNRC's official bulletin. (NNRC)

SORRY there's no space this month to re-print the List of SW ABBREVIATIONS AND SYMBOLS, which WILL BE REVISED and PUBLISHED IN AN EARLY FALL ISSUE.
—K. B.

ADEN—Stn hrd in Ar. on 7.170 frn 0337 w-talks, mx is BELIEVED to be Aden; recently s-off RATHER ABRUPTLY 0430. (Berg, Conn.)

AFGHANISTAN—Verifying in late May for rpt of 1-3-60 on TESTS over 9.573, M. L. Roma of R. Kabul said TEST was actually directed to Japan and that might begin a service to that country. (Niblack, Ind.)

AUSTRIA—Vienna has been TESTING on mny fqs lately at various hrs—such as 6.155, 7.135, 7.245, 9.505, 9.504, 9.610, 9.615, 9.665, 11.775, 11.785, 17.755, 17.795. (DW)

AUSTRALIA—R. Australia now has a JAPANESE SERV. 1000-1100, VLB11, 11.760, and VLG9 in the 31-m. band (latter fq undetermined at press time). (Roth Conn.) Has a NEW SERVICE for listeners—gives propagation condx which may affect certain areas. (Howald, Calif., others)

"Adjacent Channel"

from The Editor of DXing Horizons

From time to time as space permits and problems arise, we plan to commandeer a page here and there for editorial purposes. If nothing else I personally hope the proper use of this page will help to clarify our personal reason for this magazine's existence.

We will also plan to make use of this precious space to occasionally bring you up to date in the *thanks department*. A publication such as ours . . . especially a new one that has yet to prove itself to readers and advertisers alike . . . owes its very existence to the wonderful and sometimes wholly unexpected response from literally "a world of sources."

INTERNAL STRUGGLES

I (and here I am inclined to use "we" interchangeably) feel that the surest way to promote closer alliance between reader and editor is through the fostering of complete understanding on both my part, and on your part. As the editor of a *news publication*, our first responsibility is to our readers. You depend on our columns for accurate and timely information about the particular phase of long distance AM BCB, FM, SW, TV or FM reception that most interests you. Perhaps you have an interest in more than one of these fields. Then you get double (or more) benefit from your subscription. But the important fact to understand here is that there are others, like yourself, interested in the fields we cover in column reporting. Financially speaking, no one portion of the group we service is sufficiently large (or responsive) to support the entire magazine. And while it may appear to you that your interest specialty is taking a back seat to others, this just is not so.

With a background in news writing, editing and airing for a commercial broadcasting station, your editor is one of the first to realize the importance in balanced display for each interest group.

This . . . balanced display with proper devotion of space for the most important news in each field . . . is our prime aim in the early stages of our development.

The amount of space devoted to each facet covered by DXing Horizons is directly proportional to (A) the number of paid subscribers

in that field, and, (B) the amount of advertising in that field.

In other words, the surest way to increase the amount of space we can devote to your prime interest section, is for you to "go out and beat the bushes for new subscribers" who react as you do, and to use every chance to tell manufacturers you "heard about it in DXing Horizons."

There is nothing we would like better than to bring you a 64 (or larger) page book each month. But growth is a painful thing, and the world is filled with doubting Thomases who are more willing to "let Jack do it," than give it a try themselves (whether it be subscribing or advertising). Our future is very bright. And hundreds of new subscribers each month are making it brighter all of the time (subscriptions . . . incidentally, are our main source of revenue). Your early confidence in this publication is greatly appreciated, and someday we hope to have the opportunity to thank each of you personally.

We do know that present readers feel we have a very vital, informative and timely publication. And someday, we feel, our early subscribers will look back with great pride upon their earliest copies of the publication that helped their hobby or business gain the recognition it so richly deserves.

CASTING A WARY EYE

In past issues we have announced the expected "Broadcast Band DX Column." It is still pending as we write. Finding a properly qualified BCB Editor (we plan to concentrate solely on foreign BCB DX news) is no real problem. But finding a properly qualified BCB DX Editor WHO HAS NO TIES WITH EXISTING BCB CLUBS is quite another matter! We will announce a decision in August.

We have been queried, and we have queried others, about such additions as a Ham Band Listeners Column, a Long Wave DX Column, and more recently, a CITIZEN'S BAND COLUMN. Again it is a matter of economics . . . whether to increase the size of present sections, or add new sections. Of course the advertising and subscription loads would have to increase proportionately to warrant any and all additions. I think we can state with a fair degree of certainty that at this time, the addition of a Citizen's Band Section (not column) is in our immediate future. More details as we do more thinking and planning. Suffice to say that a Citizen's Band Section, if added to our present offerings, would be done in such a manner as to leave no doubt in anyone's mind that we intended to be "the source of C-B news," just as with TV, FM and SW.

As always, your comments and thoughts are greatly appreciated and will be carefully analyzed.

R. B. Cooper, Jr.

BELGIAN CONGO—R. Elisabethville, hrd w-talks, nx-Fr. arnd 0415-0427, then native vocals; strg but w-CWQRM; s-off 0500. R. Leopoldville, 4.879, weak 2200 c-d; final ID by woman anncr in Fr. (Cox, Dela.)

BOLIVIA—NEW stn, R. Nacional de La Paz, 5.860, hrd opening 1100; also noted s-off 0500 w-"Warsaw Concerto" prior to Nat. Anth. (Cushen, N.Z.) NEW is CP30, R. Libertad, Santa Cruz de la Sierra, 6.230, hrd 0230-0330 w-commercials in Sp., L. Am. mx. (Tavares, Brazil)

BORNEO (NO.)—R. Sabah, 5.980, hrd 1400 s-off w-"GSTQ"; strg QRM frm a Taiwan outlet. (Balbi, Calif.)

BRAZIL—R. Nacional de Brasilia, 11.720, hrd 0100 w-POSITIVE ID by male anncr in Pt., giving LOCATION AS BRASILIA, the NEW CAPITAL of Brazil; only fair, w-QRM. (Cox, Dela.) E. Tavares Filho of BRAZILIAN DX CLUB flashes that R. Sirena, Box 6, Leopoldina, Minas Gerais, Brazil, is noted DLY to 2300 s-off on 2.410, uses 1 kw.

BULGARIA—Hrd on 9.700 at 2130 w-N-E to Eu. (Hovey, Wisc.)

BURMA—XZK2, 4.795, Rangoon, hrd at low level but readable w-mx 1312. (Howald, Calif.)

CAMEROUNS—R. Yaounde, 4.972.5, noted strg 2045-2100 c-d in Fr.; off w-Nat. Anth. (march); R. Garoua, 5. 010, hrd 2030-2100 in Fr., strg in Denmark. (Jensen)

CHINA—Chinese Press Agency, Peking, logged on 18.373 at 1245 w-musical number, then woman in N-Chinese; gud level in Dela. (Cox) R. Peking, 11.885, vy gud s-on 1100 in ENG. (Gould, W. Va.) N-E 1130 (KBLP)

CLANDESTINE—"R. Liberacion de Venezuela," 6.089A, 9.505A, widely rptd in Sp. political tirades arnd 2145-0400 (but sometimes w-mx ONLY), is DEFINITELY b-c frm DOM. REP., accgd to N. Y. TIMES. (NNRC) Howard, Mo., rpts a stn on 6.410A s-on 0635A in Sp. w-bugle call, then anthem; much mention of CUBA; s-off 0730 after bugle call, anthem again.

CONGO REP. — R. Brazzaville has MOVED frm 11.725 to OLD 11.970 channel for DLY xmsn to N. Am. now 2300-0230; E-N 0115, 0215. (Huff, Balbi, Calif.; Niblack, Ind., others) Still hrd on 11.725 in other xmsns, however; noted s-on 1600. (Niblack) Has ADDED 21.500 to fqs used frm 0430 s-on to 0730 s-off.

COOK IS.—ZK1ZA, 4.965, R. Raratonga, is on NEW EXTENDED sked of THUR. ONLY 0430-0630; 500 w.; also now has N-E and a local lang, items read alternately, during last 10 min of each wkly xmsn. (Cushen, N.Z.)

CUBA — COBZ, 9.030, Havana, gud in Ont. 0000-0100 in Sp. (White) Also in Minn. (Rowell)

CURACAO—R. Curom, Willemstad, appears to have VACATED 9.654. (Niblack, Ind.; Stark, Texas)

CZECHOSLOVAKIA—R. Prague is using NEW fqs this SUMMER of 6.080, 7.255, 15.230, 15.410, 17.755, 17.760, 17.790, 11.990—PARTICULARLY WANTS RPTS ON LATTER.

DAHOMY — R. Cotonou, MOVED to 4.870 frm 4.875, noted 2200. (Cox, Dela.)

DOMINICAN REP.—HI1Z is noted BACK on 6.120 frm 6.113. (Stark, Texas)

ENGLAND—ISWC says BBC xmsns are AGAIN BEING JAMMED.

FIJI—QSL frm Fiji B-C Comm. for VRH5, 5.980,

lists VRH4, 3.980, 500 w.; VRH5, 5.980, and VRH6, each w-250 watts. (Roth, Conn.)

FINLAND — ENG. prgms, prepared by FINLANDS DX-CLUB, are on NEW sked—MON. 1600-1630 to Eu., 2030-2100 to N. Am., 15.190, 17.800; FRI. 1600-1630 to Eu., 2030-2100 to N. Am., 15.190, 17.800, and 2100-2130 to Eu., 6.120. (Eklbom, DX Editor, FDXC)

FRANCE—After N-E 1300-1315 on 21.620, RTF has pop mx w-ENG. anncmts; believed DLY. (Berg, Conn.)

GERMANY (WEST — FED. REP.) — NDR, 3.975, hrd arnd 2030 w-concert. (Pearce, England)

GHANA—Accra hrd TESTING w-anncmts in both ENG., Fr. on 7.130 at 0530-0600; 9.545 at 0600-0630, and 11.740 at 0700-0730; strg on first two, latter only fair in Calif. (Balbi) TESTS on 9.545 also rptd to DXH by Niblack, Ind., Gould, W. Va. Accra, 3.366, hrd in England by Pearce w-E-N 2100.

GUATEMALA — Sked frm R. Nacional de Quezaltenango lists TGQA, 6.110, on air 1255-0400 (SUN. 1855-0200); marimba mx sked 1800-1845, 0200-0245 (SUN. 1800-1845, 2000-2045, 2300-2345). (Riggs, Calif.) However, widely rptd over parallel TGQB, 11.700. Excellent sigs widely rptd frm TGJA, 5.990A, Guatemala City, 0430-0500 w-prgm sponsored by Guatemalan International Airways; both ENG.-Sp. anncmts; says will send postcard QSL for rpts to Airways Office, Int. Airport, Guatemala City; features much marimba mx. (Cushen, N.Z., others)

GUINEA (PT.) — QSL lists CQM 2100-2300 DLY on 7.948, 500 w. (Boice, Conn., others) Hrd in June 2250 w-dance instrumentals, anncr in Pt. on 7.947M. (Cox, Dela.)

HAITI — When NEW xmtrs are installed at 4VEH, Cap Haitien, that stn will again use the 25-m. band (11.850) in addition to other bands. (KBLP)

"OPERATION AMAZONIA"

Eddie Startz of HAPPY STATION FAME (since 1928) has appealed for financial help (IRC's or money orders) to be sent to THE HAPPY STATION, Box 222, Hilversum, Holland (mark top of envelope "Operation Amazonia," please), to help two missionaries in S. Am., who have penetrated the deep forest lands. The mission is to assist the Amazon Indians to overcome their numerous diseases and medieval superstitions. Funds are particularly needed for medical supplies. (DSWC)

HOLLAND—Rowell, Minn., rcd word from R. Nederland that EASTER MIDNIGHT MASS on 11.730 "was a ceremonious Midnight Mass on the occasion of Easter Vigil and emanated from the Scholasticism of the Montfort Fathers in the village of Oeschot in the Province of Brabant." Recently, H.R.H. Prince Bernhard dedicated NEW installations of R. Nederland—including a multielement antenna array that allows simultaneous transmissions on various fqs; two 50-kw. rigs, and a 10-kw. xmtr for Eu. coverage. (D. Cooper, S.C., others) SCDXers listed location as Lopik, and said THREE xmtrs of 100 kw., ONE of 50 kw., and one of 10 kw. were officially inaugurated.

HONDURAS—R. Tegucigalpa, HRTL2, 6.035, 0330-0400 excellent w-classical mx. (Roth, Conn.)

INDIA — AIR, 15.105, noted 1030-1100 w-beautiful native-type mx w-ENG. commentary about same. (Gould, W. Va.) Beam to Eu.-Brt. 1945-2045 is now on 9.580, 11.710. (SCDXers)

INDONESIA—Djakarta, 7.293, noted in ENG. 1140A. (Cox, Dela.) Should have N-E 1120A. (KBLP) YDR3, 3.241, Ambon, noted 1320-1332 w-rmx; fair. (Howald, Calif.)

IRAQ—R. Baghdad, 6.030, has N-E, then commentary, mx 2100-2130. (Pearce, England)

ITALY—R. Roma, 9.575, excellent in Okla. w-N-E 0305 in WCNA beam. (Stephenson)

JAPAN—JOZ, 3.925, Tokyo, commercial stn, hrd 1213 in Japanese, strg; FEN, 3.800, AFRS, noted 1216 w-ID in ENG., fair. (Howald, Calif.) FEN3, 15.275, hrd in ENG. w-varied prgms 0415-0430. (MacKenzie, Calif.)

KENYA—Nairobi, 4.885, hrd recently 0335 w-classical mx, ENG. ID by male anncr, altho sked in Swahili; may use Swahili on CERTAIN days, POSSIBLY ALTERNATELY w-4.934 outlet. (Cox, Dela.)

KOREA (NO.)—R. Pyongyang, 6.250, anncg as "The Korean Central Broadcasting Station," now has N-E 1330 DLY; 6.195 outlet has SEPARATE PRGM in Asiatic lang then. (Balbi, Calif.)

KOREA (SO.)—HLK6, 11.925, Seoul, noted in ENG. now 1430-1530, ANNCG beamed to U.S.A.; Asian xmsn 1400-1500, FORMERLY on 9.640, is now radiated over HLK42, 17.890, but is NOT AUDIBLE in Calif. due strg QRM from HCJB, Quito, Ecuador; the 11.925 outlet more recently hrd 2200-2300 to Eu.; ENG. to 2230 (N-E 2200), then Fr. to s-off. (Balbi) Uses NEW channels of HLK41, 15.125, HLK42, 17.890, to WCNA 0530-0630 (MAILBAG SUN. 0545); also hrd to Hawaii 0730-0830 on 17.890. (Cushen, N.Z.) Uses 11.925 ALSO 1600-1700; GOS 0930-1000, 6.035, 9.640; to Japan 1200-1300, 6.035, 9.640, acdgd to latest sked. (Riggs, Calif.)

LIBERIA—ELWA, Monrovia, logged on NEW 15.080 channel 1600-1800 in xmsn to the CONGO in Fr., native; POSITIVE ID; varies fair to strg. On 11.823, has Fr. 0530-0600, then ENG. to 0730 c-d; SAT, s-off 0800, SUN. hrd to 0845 c-d; ANNCES 21.535 is PARALLEL but latter IN-AUDIBLE in Calif.; AFTER 0600, the 4.770 parallel is fair level. (Balbi) Mid-June, 11.823 was vgy gd in W. Va. to c-d 0730. (KBLP) Acddg to GDX-aren, Sweden, QRA for Liberian B-C Corp., 4.255, is c/o Bureau of Information, Monrovia; director is Jim Jackson; veried via airmail ltr after fortnight, says Goran Eklundh, Finland.

LIBYA—Benghazi, 3.305, hrd in England 2100-2200 c-d W-Ar. (Pearce)

MAURETANIA — R. Mauretania, 4.885, hrd opening 0655 w-ID in Fr., Korean reading to 0710, then ID in Fr. again. (Cushen, N.Z.)

MAURITIUS—Forest Side, 6.101, hrd 0300 in Fr., 0400 w-N-E; c-d 0415. (Ridgeway, S. Af.) hrd fair level in N.Z. on 3.325 at 1700-1730 c-D, and by Anderson in Australia REGULARLY arnd 1600. (RADX)

MONACO — Young, England, says R. Monte Carlo's LISTED 7.140 outlet is hrd REGULARLY ON MEASURED 7.133.

MOROCCO—King Mohammed V recently inaugurated a 50-kw. and two 10-kw. SW xmtrs at Sebba-Aioun for b-c in Ar., Fr., ENG., Sp on seven fqs to Af., Middle East; for 80 hrs wkly. Hrd w-Ar. chants on 11.735 arnd 2215 to AFTER 2300. (Berg,

Conn.; Niblack, Ind., others) N-E 1815. (DW) Observed on 9.505 in Ar. probably parallel 7.115, 11.735 outlets. (Berg) Hrd s-on 0630 on 6.189 w-musical number, then Ar. chants; strg, parallel 7.115. (Cox, Dela.) Hrd on 7.115 at 2335 in Ar. to s-off 2400. (Boice, Conn.)

MOZAMBIQUE—Lourenco Marques, 11.760A, 9.616A, noted arnd 0400-0500. (MacKenzie, Calif.) Acddg to officials of R. Clube de Mocambique, Lourenco Marques, Emmissor Regional de Norte is at Nampula (Caixa Postal 93), and Emmissor Regional de Zambasis is at Quelimane (Caixa Postal 333).

NEW ZEALAND—ZL2, 9.540, Wellington, is operating to AFTER 1530 w-relays frm S. Af. of games of NEW ZEALAND RUGBY TOUR; games are on SAT., main ones July 23, Aug. 13, 27. (Cushen, N.Z.)

WRH SUMMER SUPPLEMENT

THE SUMMER SUPPLEMENT OF WORLD RADIO-TELEVISION HANDBOOK should now be available (for \$1) from Gilfer Associates, P. O. Box 239, Grand Central Station, New York 17, N.Y.

PERU—R. America, 3.240M, Lima, hrd parallel 9.452.5 at 0030, strg in Sp. by man; OBX4Y, 3.299, Huancayo, gd 0417 AFTER BHBS s-off; hrd w-Sp. vocals. (Cox, Dela.)

PHILIPPINES—Cushen, N.Z., has rcd verie frm UNIVERSITY OF THE PHILIPPINES which says DZUP, 7.240, w-prgms by U. students, operates DLY 0900-1300; plans to UP power from 500 w. to 1 kw. shortly; began SW xmsns 1-11-60. Acddg to verie rcd by KBLP, FEBC has "SHORTWAVE MAILBAG" sessions WED. 1515, 9.730, 11.855, 15.300, 17.805, and FRI. 1600, 11.920, 21.515 (NOW ACTUALLY 21.495). Balbi, Calif., flashes that FEBC, 11.920, now noted 1030 s-on to 1630 s-off; ENG. 1430-1630, N-E 1545 21.495 IN-AUDIBLE; 17.805 hrd 1630-1800 s-off, also on 15.300, 11.855 (JUST ADDED w-s-on 1630), 9.730; Russian xmsn is now ONE HR LONGER; ID in Russian, no anthem at s-off—when all four outlets are parallel.

PORTUGAL—Emissora Nacional, 21.495, Lisbon, noted w-ENG. 1345-1430. (Wilt, Ohio, via THE DX-ER) Hrd parallel on 17.880 (KBLP)

REUNION — R. Reunion has RETURNED to 3.380 frm 3.450; sked MON.-SAT. 0230-0345, 0800-1030, 1400-1800 (SUN. 0400-1800). (Ridgeway, S. Af., via RADX)

RHODESIA—Zomba, Nyasaland, is a NEW stn on 3.955 w-2 kw. b-c Third African Prgm 1600-1900; Lusaka has REPLACED 3.955 w-3.346. (Jones, England, via SCDXers)

RUANDI-URUNDI—Acddg to a Belgian newspaper, R. Usumbura was INAUGURATED IN MAY by the Resident-General, Jean Paul Harroy; operates on 6.195 w-3 kw; sked unknown. (Vlaminck, Belgium, via SCDXers)

SAO TOME E PRINCIPE—R. Clube de Sao Tome, 4.807, at times can be hrd to 2100 s-off. (Wood via RADX)

SAUDI ARABIA—Mecca (relayed by Djeddah) noted on 11.950 at 1830 tune-in; all-Ar., man talking to 1858, short musical number, then ID: "Huna Mecca;" off air 1859 for few seconds, then returned in Ar.; SINPO 33443 in Conn. (Boice)

SENEGAL—R. Mali is now on 4.955, NOT 4.950; hrd late as 2342 w-gong, man in Fr., then s-off 2344 after IS; strg. R. Senegal, also Dakar, MOVED frm 4.893 to 4.890, hrd 2215 w-woman in Fr. (Cox, Dela.) Hrd in Md. 0530-0705 w-gud sig. R. Mali on 4.955 noted w-strg sig 0648-0725. (Holbrook) R. Mali, 11.895A, Dakar, observed 2000-2025 in Fr., w-mx; ENG. ID, then N-E 2025; anncd as also on 4.955. (Rowell, Minn.)

SINGAPORE—BBSFES, 15.435, gud level 1200-1300 w-musical requests. (Boggs, Mo.)

SOLOMON IS. (BRT.)—As of mid-June, VQO2, 5.960, Honoiara, was still coming thru well in W. Va. to 1040 c-d w-"GSTQ." QSL rcd via surface mail fater SEVERAL WKS. (KBLP)

SUDAN—R. Omdurman on NEW 7.200M strg s-on 0413 in Ar.; as expected, HAS HAM QRM! (Cox, Dela.) Noted w-nice sig 2230-2319 s-off w-Ar. mx; final ID of "Huna Omdurman, dar al Izaa el Sudan" given just before Sudanese Nat. Anth. (Berg, Conn.)

SURINAM—AT PRESS TIME, AVROS, Paramaribo, was BACK on 15.460A frm 15.405 arnd 2130-0230; keeps "changing" from one to the other. (Roth, Conn.; Balbi, Calif.)

SWEDEN—The DX-ER is a brand-new publication (ALL-ENG.) edited by Sven Elfving, Solgardsgaten 15, Ornskoldsvik, SWEDEN, whose article on SWL'g in "THE LAND OF THE MID-NIGHT SUN" is currently in DXH. TO BE ISSUED EVERY THIRD WEEK THRU DEC.; write DIRECT to Elfving for FREE SAMPLE and details. Boggs, Mo., says R. Sweden, 15.240, is fair 1445-1500 w-ENG. talk, mx. Hrd by KBLP on 17.840 in ENG. 1500.

SWITZERLAND—SBC's DX SESSION has been EXTENDED TO 15 MIN WKLY; on FIRST, THIRD TUE. has rpt on foreign b-c stns (by monitor OTTO BERNER); SECOND, FOURTH TUE. has summary of propagation condx, general DX nx by Swiss radio amateur BOB THOMANN (HB9GX); EACH DX PRGM also includes MAILBAG in which DX Editor or BERNARD LEEMAN replies to listeners' letters and acknowledges rpts. TO DEVELOP CLOSER CONTACT W-LISTENERS, SWLS ARE INVITED TO SEND RECORDED ITEMS OF GENERAL INTEREST—descriptions of equipment, unusual prgms and experiences—to Mr. Leemann; KEEP TAPE TO 4 MIN—recorded at 3/4, 7/2, or 15 ips on SINGLE TRACK, please. WRITTEN rpts (to be read in studio also are welcome. (SBC)

TAIWAN (FORMOSA)—Taipei is now using NEW 11.735 outlet in ENG. xmsn opening 1005 parallel 15.345, 17.785; all three strg in Calif.; is NOT using 7.234 or 15.225 any longer in this xmsn; N-E 1015 DLY EXCEPT SUN.; Japanese frm 1050-1120 c-d. (Balbi) Hrd recently in 11.755 at 0225 in Chinese. (Rowell, Minn.)

TCHAD—R. Tchad, 4.904, Ft. Lamy, observed w-top tunes arnd 2030. (Borge Eriksson, Sweden)

THAILAND—Mid-June, R. Thailand, Bangkok, was noted on NEW 25-m. fq, LISTED HSK7, 11.910A, but anncg HSK9, w-E-N 1030; ENG. commentary (usually from UN or division thereof) 1115A; vy gud level in W. Va. (KBLP) MOVED here frm 11.670, may be low as 11.906 at times; hrd 0925-1400 s-off. (Balbi, Calif.)

TOGO—R. Lome, 5.036, hrd 2130 w-N-Fr., then pop mx 2142. (Borge Eriksson, Sweden)

TUNISIA—R. Tunis noted on NEW 6.105 at 1900. (SCDXers) Observed in Conn. on 11.940A

at 2030 tune-in w-talks by man in Ar., some mx; 2059 1/2 had 3 time pips, ID "Huna Tunis," followed by fanfare, then cont'd w-talk in Ar.; "gone" by 2115 recheck; SINPO 45444. (Boice)

UNID—Stn hrd on 7.295 at 2325 w-guitar and orchestral selections; "clobbered" 2341; may be EAJ8AB, SANARY IS. (Berg, Conn.)

UNION OF S. AF.—SABC recently observed on 7.229, 7.275, 7.295, 9.523, 9.720, all strg in Calif. 1330; 0600 SABC fair to gud on 11.900; 0700 fair on 11.937, 9.523, 9.720. (Balbi)

UPPER VOLTA—R. Ouagadougou, 4.815, hrd 1840-1910 in native, Af. folk songs, nx; another day hrd to 2045 and later; QRM'd by SABC. (Jensen, Denmark)

URUGUAY—CXA10, SODRE, 11.900, Montevideo, hrd 2230-0300 w-Sp. anncmts for classical mx, also chamber mx. (Rowell, Minn.)

U.S.A.—An official of the FAR EAST BROADCASTING CO. informs DXH that KGEI, San Francisco—w-xmtr at Belmont, Calif., which has been operating on 17.795 to L. Am.—has been acquired by FEBC and SOON WILL BEAM MIS-SIONARY PRGMS TO THE ORIENT.

USSR—Alma Ata, Kazakh SSR, 10.530, hrd 0028 s-on w-flute IS; "local" anthem 0030, then orchestral, exercises; nx in native 0100; "lost" in QRM 0115. (Berg, Conn.)

USSR REGIONALS IN EUROPE

Frm Latvia, Viegner flashes that R. Esthonia, Tallin, has SW outlet sked on 6.085, 1900-2300 in Esthonian; audible in Riga but seems NEAR-ER 6.080 to 6.083; R. Georgia, Tbilisi, operates on 5.040 in Georgian, mostly RELAYING LW 191 kc; another outlet, FORMERLY was LISTED on 4.544 at 1515-1800 in Armenian, Azerbaidjan; R. Azerbaidjan, 4.958, Baku, 0200-2100, RELAYS LW 218 kc; R. Armenia, 5.740, Erevan, 0230-2100, RELAYS MW 863 kc., EXCEPT 2030-2150 when has SECOND PRGM on SW ONLY; TWO SW outlets (5.065, 6.055), at Petrozavodsk, Karelia, NEAR FINLAND, are rptd b-c in Karelian, Finnish, Russian; relay MW 611 kc. AND R. Moscow; R. Kiev, Ukraine, operates SEVERAL POWERFUL SW outlets; often hrd on 6.020, 11.720, 11.735, 11.890, RELAYING Kiev LW 236 kc AND R. Moscow; also has special b-c for Ukrainian-spkg population in America.

VIETNAM (NO.)—Fair on 15.020 at 1300-1330 w-mx, commentary in native. (Boggs, Mo.)

WINDWARD IS.—WIBS, 15.085, St. George's, Grenada, RELAYS R. Newsreel frm BBC, London, 0000. (Hovey, Wisc.) NEW HF b-c skeds will come into operation Sept. 4, when WIBS will use OTHER FQS TO REPLACE those now employed. In particular, 15.085 will be REPLACED by another 19-m. band fq. (NNRC)

DEADLINE—PLEASE send YOUR TOP-NOTCH DX ITEMS TO REACH ME BY THE FIRST DAY OF ANY MONTH FOR "WT" SECTION. Send ONLY "RARE CATCHES" TO REACH ME BY AUG. 12 for "AT FADE-OUT" in SEPT. DXH. Thanks for your swell cooperation! QRA is Ken Boord, 948 Stewartstown Road, Morgantown, West Virginia, U.S.A. See YOU next month?... 73... K. B

SITCO

Heavy Duty Quads and Yagis

Designed by SITCO for Translator off-the-air pickup, Community TV and extreme fringe area requirements.

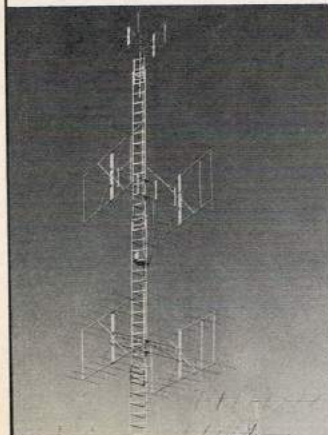

A Typical SITCO Installation

The SITCO Models 94 and 102 Quad Mount Antenna Arrays are designed to produce high gain, high front-to-back ratio and large aperture to weak signals. A completely balanced system which reduces noise pick-up and greatly improves the signal-to-noise ratio.

NOW, all SITCO element ends are machined to reduce static leakage. The signal-to-noise ratio is increased at sites where signal levels are low.

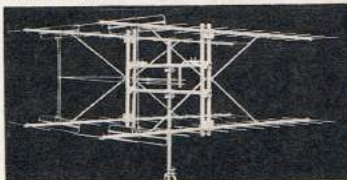

Model No. 102-HD 48-element Quad

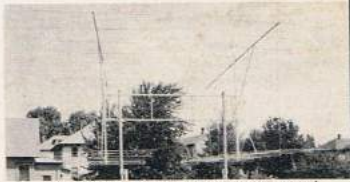

Model No. 94-HD 32-element Quad

SIMPLICITY TOOL COMPANY

2850 NORTH MISSISSIPPI • PORTLAND 12, OREGON

SUBSCRIBE TODAY!

Postmaster: Form 3547 Requested

BULK RATE
U. S. POSTAGE
PAID
Permit No. 53
Modesto, Calif.

U.S.A.
P. O. BOX 3150
MODESTO, CALIFORNIA