

MARCH 1961
40 CENTS

DXing HORIZONS

FIRST REPORT IN APRIL...

**"What the FCC has been
told about UHF"**

EVALUATION OF RECEIVING TECHNIQUES
SUITABLE FOR UHF-TV RECEPTION

REPORT NO. 8432-1
August 1960
CONTRACT RC-9794

Prepared for

FEDERAL COMMUNICATIONS COMMISSION
WASHINGTON, D.C.

Airborne Instruments Laboratory
A DIVISION OF CUTLER-HAMMER, INC.
DEER PARK, LONG ISLAND, NEW YORK



DEVOTED ENTIRELY TO RADIO AND TELEVISION DX RECEPTION

**"Western Translator Conference"
WERE YOU THERE?**



It's easy to add the new JERROLD FM equipment package

Now you can take advantage of the boom in FM listening! Add the extra value of one or more FM channels to your present cable service—economically! Here's all you need to get extra subscriber-appeal:

- FM antenna
- FM tuner
- FM modulator for originating your own audio (record, tape, microphone)
- In-the-home FM tap
- For weak-signal areas only, an FM pre-amp

All the components are Jerrold-made with the exception of the antenna and the Scott 310DR Tuner, which we've selected as an integral part of the package. If your system has Jerrold trunk-line equipment manufactured during the past three years, no adjustment should be needed for adding FM. Only minor amplifier realignment is needed on earlier equipment.

Give your present subscribers more, and you'll attract more subscribers. FM radio will add a valuable *plus* to your CATV system.

Here's how simple it is to add FM to your system

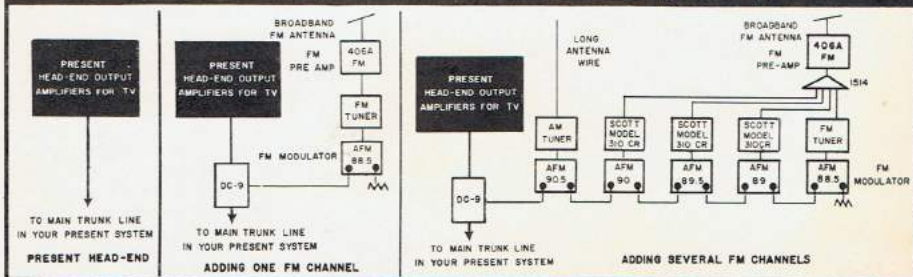

ORDER FROM YOUR JERROLD FACTORY REPRESENTATIVE
or call or write the Jerrold Community Systems Division for full information.

JERROLD

ELECTRONICS CORPORATION

Community Systems Division

The Jerrold Building, Philadelphia 32, Pa. Telephone 215 BALDwin 6-3456

Channel

1

News, Exclusive Reports and Marketing Tips to Fringe Area Television Enthusiasts

IN MAY

... DXing HORIZONS to become TELEVISION HORIZONS

Some wise soul once said "Nothing succeeds like success." We believe this!

DXing HORIZONS began as a spare time task for your editor in the fall of 1959. We had an idea . . . that the fringe area television market was not dead. We gazed at figures issued by the NAB which revealed eight percent of the American public was still beyond the range of three or more television stations (thereby without a three network choice of programs). We decided to breath new life into the fringe area television market by giving it a spokesman all its own. And so DXing HORIZONS was born.

Today with the course of history shifting the television tide to UHF and the last vestiges of 15.4 million "snow-stricken American viewers" disappearing under the ever pressing frontiers of VHF-UHF Translators and Cabled television, we see a surprising "re-awakening" that good quality television for rural America is still a long ways off.

To meet this new and expanding horizon in video reception, to provide an even more informative and useful format to our "TV depressed area" readers, DXing Horizons will in May become "TELEVISION HORIZONS."

Our non-television material (with the exception of FM news) will be moved into our new publication "COMMUNICATION HORIZONS." And our new TELEVISION HORIZONS will be expanded to include all phases and approaches to distribution, rebroadcast and local origination television.

At the outset these changes will manifest themselves as "meaty improvements." A brand new section will cover the technical side of motel and hotel (as well as home) distribution systems. Our circulation will be expanded to include, nationwide, servicing shops and technicians who specialize in this field.

A second new section will follow closely "small town-low power television," a subject we feel will first get off the ground in 1961.

To handle an increased load of product reports our new Modesto offices at 1016 14th Street includes a "decently equipped" OFF THE AIR RECEPTION LAB, probably the most unique in the world.

The long and short of our expansion is the fact that we have proven the "Fringe Area Market" is far from dead. In our own estimation it is now being reborn. TELEVISION HORIZONS will lead the way in keeping you, a vitally interested reader, informed as this transformation takes place.

R. B. Cooper, Jr., Editor

MYSTERIOUS TRAVELER IN THE NORTHWEST

The broadcast industry just may be more aware of the pending VHF to UHF allocation move for television than it has led many to believe.

During mid and late February a dapper young man representing himself as a "go between" interviewed several UHF Translator Associations in the northwest as to their views on UHF coverage. Said the young man, "I represent XXXX-TV and we want to know whether your Translator Association would be interested in 'getting out of the business' and turning your Translator's operation over to us."

The "middle man" explained his station is concerned over the possible switch to UHF, and wants to line up already operating UHF Translators to carry that station's signals. He noted his station expects to loose considerable "direct coverage" when it is forced to UHF but wants to compensate for that loss by having a ready reserve of UHF Translators to fill in the holes.

One UHF Translator group expressed indignation over the query, others said "we are enthused over the possibility of getting out of this rat race."

Now the \$64.00 question. What happens when other broadcasters get the word and begin to do a little "Translator Courting" of their own? The fun is just beginning!

KNBS-TV WALLA WALLA WILL RETURN TO AIR

According to a source close to now defunct KNBS-TV, channel 22, Walla Walla, Washington, the station's recent "close down" (in December, 1960) was only temporary. A purchase of the station is pending by a Portland Broadcaster, which apparently plans to operate the station as a satellite.

SECOND "ON CHANNEL UHF BOOSTER" SOUGHT

In a joint filing with the FCC in mid-February, KLYD-17, Bakersfield, California (long known to DXing Horizons readers as our Modesto Lab "sig-

(Continued on page 35)

DXing HORIZONS

MARCH 1960

Volume 2, Number 3

Published monthly in Modesto, California, U.S.A., circulated in 50 states, and 74 countries, to long range-weak signal DX enthusiasts, and operators of TV distribution and rebroadcast systems. DXing Horizons is the official news publication of the World Wide DX League, an international organization of DX listeners-watchers. DXing Horizons is registered to Robert B. Cooper, Jr., 1961.

EDITORIAL OFFICES

DXing HORIZONS

P. O. Box 3150

Modesto, California, U.S.A.

Telephone LAmbert 4-7395

STAFF

Publisher-Editor
Robert B. Cooper, Jr.
(Amateur K6EDX)

ASSOCIATE EDITOR

Raymond Moore, K1DBR

Technical Director

Robert D. Grimm, K6RNQ

Circulation Department

Carole Buchanan, Manager
Jean Lee, Control

Drafting

L. C. Lang

Promotion

Stan Searle

CONTRIBUTING EDITORS

Translator Topics

James Beamer, Secretary
Tri State TV Repeater Assn.

UHF Horizons

Harlow Speckhart, President
National Assn. Low Power
Television Broadcasters

Shortwave

Kenneth R. Board

Medium Wave

Glen Kippel, WOWPO

English SW Horizons

A. R. "Al" Niblack

Propagation

Stanley Leinwall

Eastern Testing Laboratory (TV)

James Gould
1952 W. Madison
Kokomo, Indiana

SUBSCRIPTION RATES

U.S.A., Canada, Possessions

One Year.....\$ 4.00

Two Years.....7.00

Three Years.....10.00

Airmail — One Year.....7.00

Foreign Rates

One Year.....4.00

Two Years.....7.50

In Europe

The Shin Jieh Company

135, Harrowdene Road

Wembley, Middlesex

England

One Year.....£1.9.0d

Two Years.....£2.14.0d

In Australia-New Zealand

Colin Burgess

Channel Highway

Taroona, Tasmania

Australia

WEAK SIGNAL TELEVISION

Page

CAPSULE NEWS—TO DEADLINE

“Channel 1” 1

TRANSLATOR TRANSMITTING ANTENNA

“Rattlesnake TV Corner Reflector” 3

VHF-UHF TRANSLATORS

“Radio Remote Control Regulations” 6

MOUNTAIN TOPPERS

“Picking An Antenna Site” 8

UHF RECEIVING

“Home Installation”—Part two 9

CABLE DROP

“One Man’s Approach—
To A One-Man Cable System” 10

VHF TRANSLATOR NEWS

“Translator Topics” 14

WESTERN FRINGE NEWS

“News Briefs From the West” 20

BILL TO REGULATE CATV 22

FRESNO “V” TO “U” MOVE 23

TV-FM DX NEWS

“For DXers Only” 24

“The DX Enthusiast” 25

SHORTWAVE-MEDIUM WAVE DX

THE WORLD OF DX 27

SHORTWAVE STATION SALUTE

“Radio Hungary” 28

MEDIUM WAVE DXing HORIZONS 29

ENGLISH LANGUAGE HORIZONS 30

SHORTWAVE DX—OPERATING NEWS

“At Fade-Out” 31

BCB DX

“South Africa—Ultimate DX” 37

DXing Horizons is indexed in “The Electronic Guide.”

POSTMASTER: Executive Office; 1016 - 14th Street, Modesto, Calif.
Second class postage paid, Modesto, California. Send form 3579 to
DXing HORIZONS, Post Office Box 3150, Modesto, California.

What HAS the FCC been told about UHF?

Just Why is the FCC so Excited About the Ultra High Range?

What is the future of the many laboratory stage UHF receiving devices?

The Parametric Amplifier?

Antenna Mounted Tuner?

Varactor Diode?

Crystal Mixer?

UNDER AN ALL-UHF ALLOCATIONS PICTURE . . .

What is the Future of VHF TRANSLATORS? UHF TRANSLATORS? CABLE TELEVISION?

You Can't Afford NOT TO READ This Epoch-Making Series!

STARTS IN APRIL IN
DXing HORIZONS

"The trade publication with an inside track to the future of the fringe area television world."

THE APRIL ISSUE . . . Available to PAID MAIL SUBSCRIBERS ONLY!

..... Enclosed my check for \$4.00. Please reserve my April copy of DXing Horizons and enter my subscription for the next 12 issues.

(In May DXing Horizons becomes TELEVISION HORIZONS and adopts an all "weak signal-distribution" format catering exclusively to the weak signal television world.)

Name.....

(Title).....

Address.....

Town..... State.....

Enter your new subscription prior to March 20th to receive the April issue.

Return form to—

DXing HORIZONS MAGAZINE
P. O. Box 3150
Modesto, California, U.S.A.

Corner Reflector Transmitting Antenna

... for VHF Translators

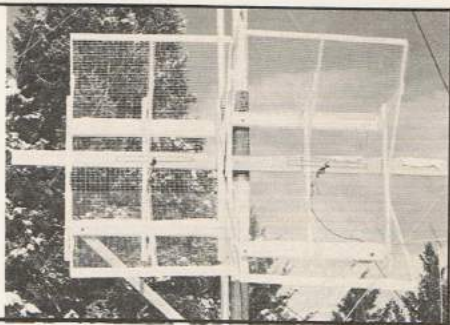

When the VHF Translator Operator has picked his receiving and transmitting site(s), chosen his Translator and generally "put the show on the road," only one real problem remains in his installation planning.

Unfortunately that problem is a universal one . . . and of great enough proportion that it is of major concern these days to virtually every VHF Booster Operator now planning his new "Translator" installation.

In the years past when VHF Boosters were coming on the air with a minimum of technical planning and downright knowhow, the choice of a transmitting antenna was seldom given much thought. Almost all VHF Booster installations use the time worn "receiving yagi" for transmitting as well as receiving. Unfortunately the choice of conventional receiving yagis for transmitting is a poor one. Receiving yagis, used for transmitting, are:

(a) *Mechanically poor* (flip out elements, $\frac{1}{8}$ - $\frac{1}{2}$ inch "soft aluminum" tubing, with seams)

(b) *Electrically poor* (high mis-match which results in low efficiency, standing waves and "un-true" patterns)

(c) *Expensive to maintain* (mountain and hill top installations are subject to the full force of the weather, and the "home type antennas" take a bad beating)

(d) *Coverage patterns must be sacrificed for "expected . . . although seldom realized . . . gain"*

Thus the long and short of using "receiving yagis for transmitting is simply, "They are a poor investment."

In many locations now served by a VHF Booster, the reception area represents a region much wider than the conventional yagi pattern can be expected to cover. But, the Booster operator needs the gain (ERP) to reach the "depths" of his area so he has stacked yagi antennas to achieve this purpose. Many installations use stacked antennas with "skewed"

upper and lower stacks to cover two directions, or "broaden out" the main lobe beyond the limits of a single yagi. While this may partially solve the problems of coverage it can introduce severe ghosting, which the home receiving antenna is not able to cope with.

The problem of selecting a transmitting antenna is then a complex one. Primarily, the signal must cover all of the area where potential viewers live and the picture Booster subscribers receive will be proof of performance.

DXing Horizons has to date contacted two commercial "ruggedized yagi" manufacturers with a proposal to manufacture "screen-reflector-dipole transmitting arrays" which could, if designed properly provide coverage patterns to meet almost any requirement. One manufacturer of VHF Translators now includes, as an accessory item, yagi transmitting (and receiving) antennas. They are, however, a bit on the expensive side (\$250.00 for channels 2-6, \$180.00 for channels 7-13), if your Booster is operating on limited capital. Nor will they, or any type of yagi, solve complex coverage problems.

All of which brings us to a "homebrew antenna" currently in use near Missoula, Montana by the "*Rattlesnake Free TV Association*."

Rattlesnake TV operates a pair of VHF units from a ridge 4 miles north of Missoula. On channel 7 a one watt unit repeats KXLF-TV (channel 4) from Butte into Missoula. The same receiving-transmitting site also houses a channel 9 Booster which repeats the local signal of KMSO-13 on channel 9. The terrain around Missoula is laid out in such a way that the KMSO signal, from a 7124 foot elevation and 191KW visual power, sprays "reflection images" (ghosts) over certain areas of town. By "translating" the channel 13 KMSO signal to channel 9 and rebroadcasting it back into Missoula, the "criss cross" coverage provided by the Booster and the TV Transmitter assures

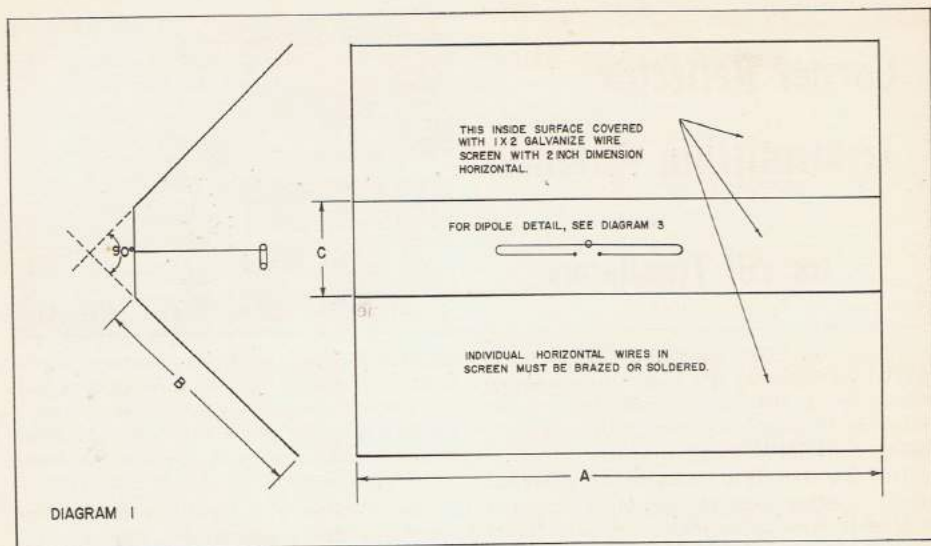

DIAGRAM 1

ghost free reception in all parts of town on at least one channel.

CORNER REFLECTOR

The "Rattlesnake TV Corner Reflector" antenna may be duplicated by translator operators across the country for a cost of under \$10.00. The component parts are inexpensive, although a little elbow grease will be expended during the construction period. The design is not original although Jim Barr, chief engineer for the project, believes the Rattlesnake installation is the first by a Translator for transmitting. The antenna is being duplicated by several Montana Translator groups who plan a general overhaul of their systems this spring as part of the "Booster to Translator" process. The Superior, Montana "Channel 4 TV Club" is constructing several for area clubs.

COVERAGE

From a transmitting location 4 miles north of Missoula the Rattlesnake TV group is faced with an area more than 110 degrees wide to cover with "Transiator Signals." Notes engineer Barr "we found that these antennas (the pair of Corner Reflectors with a common mount) gives us approximately 110 degrees of main lobe with ample gain to reach out at least 15 miles."

CONSTRUCTION

As table one clearly indicates, the dimensions recommended make the antenna "large" for the low band channels. For this reason the high band channels are recommended for transmitting where possible. However, the

low channels may be used . . . they merely require a more rigid frame to support the array during heavy wind and under icing conditions.

The wooden frame for the antenna shown in photo one is bolted together with galvanized heavy duty bolts. The frame itself should be constructed from 2x6 or 2x8 pieces. Even heavier wooden support pieces are recommended for the low channels (2-6). In addition to the actual "V" sides and the back screen (dimension "C" in diagram one), a good support pole with appropriate "trusses" (photo one) is recommended.

The screen mesh which forms the actual "reflection surface" for the antenna is constructed from a good quality wire mesh, galvanized. The mesh should have a two-inch horizontal length and one-inch vertical height between wires (this is a standard type available at most hardware stores). At each point where a horizontal wire crosses a vertical wire in the mesh the pair must be brazed or soldered together.

Once the frame is constructed and the wire mesh cut to size and brazed (or soldered) it is attached to the frame. This is done best with a heavy staple gun or heavy duty roofing nails. But whichever you use, be certain they are coated so as to be protected from the weather (musn't rust!).

DIPOLE

The dipole (driven portion of the antenna) is a rugged variety of construction built up

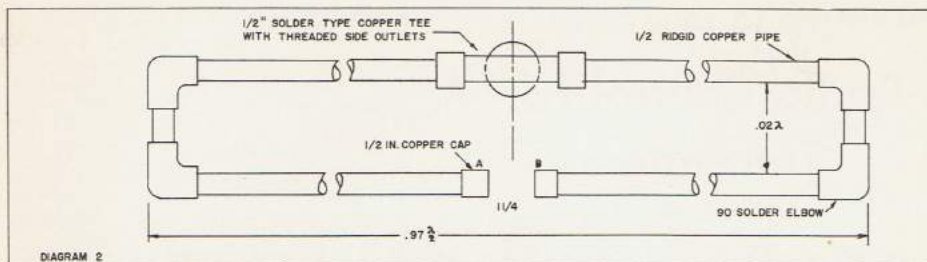

from more or less standard plumbing supplies. This includes one-half inch OD copper tubing (or pipe), four 90 degree elbow joints, and a single one-half inch ID solder type copper Tee joint. A pair of one-half inch copper "caps" to fit over the bottom "feed point" of the dipole ends is required as shown in diagram three. The dipole is essentially a "folded dipole" driven element. Therefore it has a feed impedance of approximately 288 ohms. The presence of the screen reflector behind the dipole drops this impedance slightly, so the dipole is mounted on a pole and slid forward and backward with feed line connected and transmitter running while field strength measurements are recorded to find the best "positioning for the driven element." This process will be detailed shortly.

The dipole is fed with standard 72 ohm coaxial cable (RG-11/u) through a 4 to 1 matching balun. The balun (diagram three) is actually a transformer which changes the unbalanced (coax) 72 ohm impedance to the balanced 288 ohm dipole impedance.

The dipole is connected to the feedline and balun (288 ohms here) at points A and B in diagram two (dipole construction layout). Strips of copper are bound tightly around the free floating dipole ends at points A and B, diagram two, and held in place with a medium

weight metal screw. The coaxial cable solders to a pair of "lugs" which mount under the heads of the screws. The dipole may also be drilled for a pair of holes at points A and B and the coax connected directly. *However this opens the inside of the "capped" dipole to moisture which we try to keep out with the caps.*

The important object is to connect the feed line to the dipole at points A and B.

The coaxial balun may be taped to the support pole and the coaxial cable run back along the support pole and out through a small opening in the rear of the screen section.

Table two gives the dimensions for the dipole, channels 2-13. The lengths given are .97 of one-half wavelength. The width of the dipole (height) is shown as .02 wavelength. All of these measurements are based on the use of one-half inch OD copper tubing. If you use any other size tubing, these dimensions must change.

For the purpose of this discussion, let us assume you have constructed the screen and the dipole, built the balun and have the dipole mounted (at the copper Tee joint) on the end of a length of 1 1/4 inch OD galvanized steel pipe. As shown in photo one, the pipe mounts through the screen at the exact center of the screen section "C" (diagram 2). The piece

(Continued on page 20)

Channel	2	3	4	5	6	7	8	9	10	11	12	13
A	17'	15'5"	14'1"	12'3"	11'6"	5'8"	5'6"	5'4"	5'2"	5'0"	4'10"	4'8"
B	15'	13'8"	12'5"	10'10"	10'2"	5'3"	5'1"	4'11"	4'9"	4'7"	4'6"	4'4"
C	3'6"	3'2"	2'11"	2'6"	2'4"	1'2"	1'1 1/2"	1'1"	12 1/2"	12"	11 1/2"	11"

TABLE 1

Channel	2	3	4	5	6	7	8	9	10	11	12	13
.97 1/2 wave	99 3/4"	90 1/4"	82 1/2"	71 1/4"	67"	32 1/8"	31 1/4"	30 3/8"	29 3/8"	28 3/8"	27 3/8"	26 3/8"
.02 wave	4"	3 3/4"	3 1/2"	3"	2 3/4"	1 3/8"	1 1/4"	1 1/4"	1 1/4"	1 1/4"	1 1/4"	1 1/4"

TABLE 2

Radio Control For Translators

(Part One of Three)

Isolated mountaintop sites which often house VHF and UHF Translators are many times not accessible during periods of the year when rain or snow is present. Under FCC regulations governing both VHF and UHF Translator stations, the transmitter site must be so located so as to be within 15 minutes "driving, running, walking and/or crawling time" at all times of the year. If, the FCC says, your site is not easily accessible you must have some form of "remote control" attached to the Transmitter to shut it down in case of emergency or Broadcaster-FCC directive.

"Remote Control" may be as simple as a pair of wires running up to the mountaintop from a home below or as complex as "radio control" which will accomplish the same purpose, "shut the thing off!"

More often than not, if the site cannot always be reached within 15 minutes travel time it is so isolated that "landline" (by wire) remote control is not feasible. Too much distance or terrain which does not lend itself to "laying down twisted pair cable" often accompanies truly isolated sites. In such cases the Translator operator is faced with a decision.

a) He may "fudge" on the regulations and hope he is never asked to turn off the unit in the middle of a blizzard.

b) He can approach the problem with a clear conscience free of worry over later entanglements with the FCC and adopt a radio control system.

Most Translator manufacturers are actively aware of the problems presented by sites which "demand remote control." All Translator units now on the market have some type of provision for remote control even if that provision amounts to nothing more than a switch in the B plus line of the final amplifier stage. At least one manufacturer is working on an accessory "radio-remote control package" which will be completely compatible with the actual Translator unit.

UHF Translators now on the market also include provision for "connecting in" a radio control unit.

Until such time as one or more manufacturers actually markets a radio control unit, Translator operators must mold existing equipment intended for other services into their installations (this should be no problem for VHF operators . . . they have plenty of experience with making do with what is available!).

Parts two and three of this series will explore an existing UHF Translator installation which uses Radio remote control and a proto-type VHF Translator radio control unit. It should be noted that at such time as the expected VHF unit comes on the market it will be readily adaptable to both UHF and VHF installations as the operating frequency of the Translator has little to do with the radio control circuitry.

WHAT ABOUT THE REGULATIONS?

The first step in drafting a radio remote control system for any Translator is an investigation of the types of service available through existing FCC rules and regulations.

CITIZENS RADIO SERVICE

Stations licensed in the Citizens Radio Service may be used for remote control to turn on or off TV Translator stations, or for communications between operations and maintenance personnel.

Any one of three classes (A, B and C) of Citizens Radio stations may be used for the purpose of Translator control. The following describes these classes of stations (as they pertain to Translators) and in a general way indicates how they might be used in connection with the operation of Translator stations.

CLASS A—Class A Citizens stations operate in the frequency band 460-470 mc. They (the stations) may be used for switching operations (i.e. remote switching of Translator input channel under certain licensing conditions), for transmission of signals back from the Translator to the base station (in the town below) to indicate faulty operation at the Translator and for voice transmissions in connection with the servicing and general operation of the Translator station (i.e. voice checks between the Translator site and the coverage area during transmitter adjustment periods, etc.).

CLASS B—Class B Citizens stations may be used for any of the purposes described under Class A. They operate on the nominal frequency of 465 mc. with more liberal frequency tolerances than are permitted for Class A stations, BUT, are limited to lower power than is permissible with Class A stations.

CLASS C—Class C stations operate in the 27 mc. frequency region. They may be used only for switching operations (i.e. on-off, etc.) and/or for the transmission of attention signals (i.e. automatic warning device with the 27 megacycle transmitter located at the Transmitter site to alert the operator "below" when trouble develops with the Transmitter). Class C stations may not be used for voice or telegraphic communications.

CLASS D—Class D stations, which operate in the 27 mc. region are authorized for voice only. They would not be authorized for Translator station control although they may be used in conjunction with a Class C station to check out a Translator's operation. This could be accomplished through the use of a regular Class C license to control the unit from a remote point, and the Class D license to exchange voice communications between the Translator site and the coverage area during adjustment periods.

27 MC. WARNING

Although the 27 mc. band equipment (class C and D licenses) is less expensive than equipment operating in the Class A and B service bands (460-470 mc. region), it has several drawbacks. 27 megacycle signals are susceptible to "skip," which means simply even though you carefully pick a frequency not in use in your region, signals from other stations in more populated distant regions will often "skip" into your location. Thus the

(Continued on page 23)

DEALS!

BARGAINS!

FREE
SERVICE!

"With Your Eyes Wide Open"

ARE YOU PAYING THROUGH THE NOSE?

THERE ARE NO BARGAINS IN
THE TRANSLATOR BUSINESS

LOW PRICE — MEDIUM PRICE — HIGH PRICE

Which is the BEST when you consider—

FIRST: Cost of Equipment

SECOND: Maintenance Cost

THIRD: Ability to Deliver a
Broadcast Quality Signal

LET **VUCO** ENGINEER YOUR TRANSLATOR
SYSTEM TO FIT YOUR NEEDS
AND YOUR BUDGET

"Anything for Free is Worth what it Costs"

VUCO charges for its
services—

Offering the Priceless Extra of
Experience...and a COMPLETE
Translator Service

VIDEO UTILITY CO.

2444 Market Street Seattle 7, Wash.
SUnset 4-1111



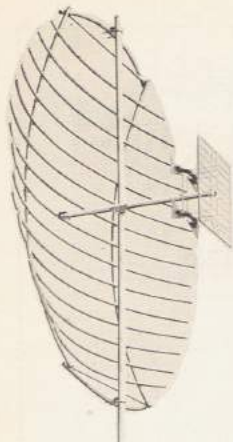

UHF HORIZONS

"News of the UHF Translator World"

Conducted Monthly by
Harlow Speckhart*
Route 1, Box 317
La Grande, Oregon

VHF-UHF TRANSLATORS

... Picking A Translator Site

(Part One of Two)

It has been said, more than once, that "the success or failure of a Translator Association depends on one initial decision." That decision is the engineering, analyzing and actual selection of a site for the Translator.

The mountain or hill top location of the Translator must serve a minimum of two causes. Primarily it must be as close as physically possible to an "electrical line of sight" path to the TV broadcast station. This is possible in many western locations at distances up to 150 airline miles from the TV transmitter.

However, there are a substantial number of locations as close to the TV transmitter as 75 miles, which because of ugly terrain barriers do not afford anything approaching a line of sight path.

It should be noted here that "line of sight" is an electrical measurement which actually extends one-third the distance beyond the visual horizon. Thus if you are able to visually see 75 miles "towards the TV transmitter," which is located 100 miles away, it is usually safe to assume your site is within "electrical line of sight" of the TV transmitter. Actually the visual sighting should be made from the top of the TV broadcasting tower and not the receiving point where the Translator is located.

But what happens if your site does not fall within the "electrical line of sight?" In some rare instances, perhaps not too much. In most cases however, the signal level under "non-line of sight conditions" will show erratic fading tendencies subject to greater changes due to weather variations than could be expected "within a line of sight path."

In terms of compensating for these changes the "non-line of sight" Translator operator must build into his receiving system greater tolerances for



fading and generally expect his "median signal level" to run as low as 75 to 200 uV.

With the installation "within a line of sight path," the Translator operator can normally expect signal levels to average 200-2,000 uV at distances up to 150 miles. And his median signal level will show approximately 50% less variation (above and below the average level) than the same site (distance wise) "not within line of sight."

DOLLARS AND CENTS

Translator receiving sites "below" line of sight can expect to spend a minimum of \$250.00 "over and above the cost of a normal Translator receiving installation" IF you want to properly compensate for the more erratic and low level signal. This will include a low noise antenna mounted pre-amplifier to boost the signal at the point of interception and substantial "beefing up" of the AGC (automatic gain control) circuits.

SOCIAL ASPECTS OF SITE SELECTION

Selection of the site is important from an economic point of view. It is important that a Translator maintain a high quality "rebroadcast signal" at all times. This is especially true of the non-profit operator who depends on voluntary financial support to meet operating expenses. Anyone knows the public will not subscribe to a snowy—seldom watchable picture.

Keep in mind that selecting your site, for both receiving and transmitting, will make the difference between a good and poor signal broadcast from the Translator. Also keep in mind the Translator site must not be selected for its receiving capabilities alone. You are rebroadcasting through a very low power unit. Therefore you must have "line of sight coverage" to the people and homes within your defined coverage area.

In some cases, the site can be broken down into "one for receiving, and one for transmitting." Surprisingly enough, the best receiving sites are usually found slightly below the top of the ridge or mountain selected, locating the receiving antennas on the side of the slope towards the broadcast station. It would appear the ground behind the receiving antennas affords a reflector surface which seems to cut down the fading on received signals.

By the same token you will find your best Translator transmitting site to be at the top of the mountain, or close to it. In many installations the receiving and transmitting sites are separate and a "miniature Cable System" feeds to the Translator from the receiving antennas.

A Translator site should be selected with an eye to covering as much of the immediate surround-

ing population as possible. The more homes receiving the signal the better the chances for economic survival. A large volume of homes is necessary to raise the necessary funds to not only buy the original equipment but also to hire a qualified service technician to maintain the unit. The very best received signal coupled with the very best in equipment will not assure the success of your Translator, IF the equipment is placed in the hands of an incompetent technician.

The best technicians are in a position to command top wages. And in terms of dollars and cents this means you must select a site which will deliver the Translator signal to as many homes as possible in order to take in sufficient donation monies to hire a top technician. And, in turn, he will maintain the unit at peak operating performance, which will in itself assure maximum viewer interest, and the greatest monies coming in to sustain the operation. It is the age old question of which comes first, the chicken or the egg. Only in the case of a Translator the answer is obvious ... the proper selection of a site, to accomplish BOTH the chicken and the egg!

ELEVATION AND CONTOUR MAPS

As your location moves further and further "back" from the broadcasting station, "height" at the receiving location becomes more and more important.

One of the best methods of determining "possible" sites for your area's Translator involves a little pre-planning work with a contour map "before" you begin to probe nearby mountain tops with a field strength meter. The National Geodetic Survey Department (office in Denver) provides maps at a minimum cost which detail, accurately, the land contours for almost any section of the country. The maps are purchased in "quadrants" and you will need to describe the path (i.e. "It runs northwest from Butte to Missoula") when ordering. When the maps arrive, attach them together so they show the complete path from the broadcasting tower to your town. Around your town you will spot hills and mountains you know well. Each mountain and hill is laid out in "contours" which indicates to you exactly how high it is, and its slope. From the TV broadcasting tower site to the top of the various "possible" sites around your coverage area, you can lay out a straightedge line. This line will cross over many mountains and hills on the way to your area. "It is these mountains which will present you with possible barriers to receiving adequate signal."

Photo one shows a typical "layout session" using a terrain map and straightedge. Diagram one is a "profile map drawn to scale" which literally turns our straightedge path "up on its edge" so you may view the entire path for line of sight possibilities.

All of this should be done with each of several possible sites before you begin the arduous task of climbing about the mountain tops with a portable field strength meter.

WATCH OUT FOR...

When measuring signals, once you have begun actual field testing of sites, it is best to include a portable field strength meter (with adjustable AGC) a simple 3-5 element yagi for the channel you are probing and a moderately sensitive television receiver. The field strength meter will give you your best indication of signal fluctuation but

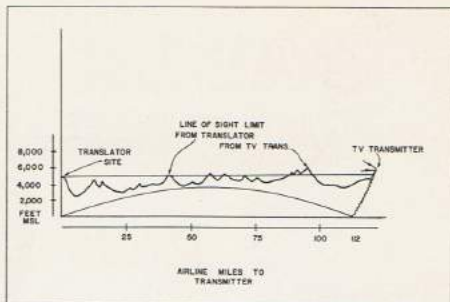

you will need the receiver to probe for possible ghost path signals and the severity of fading.

Most engineers recommend a minimum of 100 hours be spent recording the signal level at your "hand-picked site" before you actually make a final decision. This is however a rather long period of time to spend on a mountaintop away from the shelter of home. And you just might run into a week long period of exceptional signals which would disappear before the Translator installation was completed.

It is therefore recommended that several 3-4 hour observation periods be conducted at your selected site, spanning a period of ten days to two weeks, and different periods of the day. When you have put in 15-20 hours in this manner, you will know whether the site will prove up to your needs or not.

IN APRIL...

This two-part series will conclude with an analysis of seasonal variations, and the proper method for maintaining the signal level(s) at your selected site.

The UHF Home Receiving Installation

(Conclusion)

By
Edward Pellissier
Rt. 1, Box 281A
Hermiston, Oregon

In the February DXing Horizons, experimenter Pellissier discussed his experience with antennas and feedlines. This concluding portion details his views on the home receiving site for UHF television.

UHF TUNER

With the signal as far as the receiver, the question is "what is the best way to convert the UHF signal to the VHF receiver and lose as little signal as possible in the process." Most UHF set mounted tuners consist solely of a 6AF4A mixer. Only a few have a separate tuner for UHF which also boasts an IF amplifier tube. No set yet has an RF amplifier at UHF so the trick is to get a unit with the "lowest loss-lowest noise figure mixer." The very best are poor by VHF standards ... running

(Continued on page 38)

CABLE

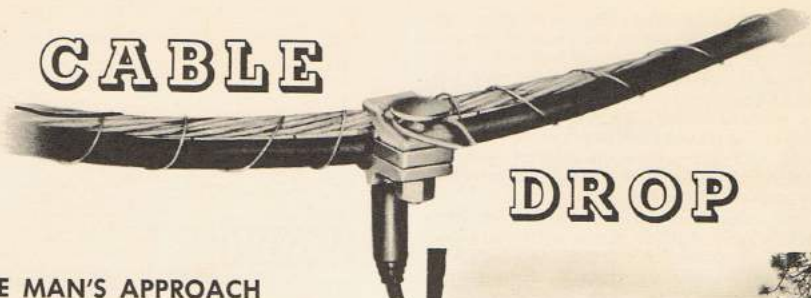

DROP

ONE MAN'S APPROACH ... to a One-Man Cable System

It's a quiet overcast wintery day in central California. You are winding your way east on highway 140, leaving the 60 foot television antennas of Merced, California behind you and climbing into the foothills of the great Sierra Nevada mountain range. Ahead of you, shrouded in a heavy grey mist is the majestic splendor of 12,000 foot peaks deep with soft fallen snow and receiving a great deal more even as you begin the ascent from the desert dry valley. 70 miles due east is Yosemite National Park, a vast government preserve carved out of a land that saw its first white settler only 100 years ago. Between you and Yosemite lies a town well removed from the hurry-burry of rapid paced California life, sunk deep beneath the peaks of America's greatest mountain range. *Mariposa, California*—a county seat, an old gold rush town and a semi-historical monument. *Mariposa*—trying hard to stay alive with 3,000 odd soles who brave the 100 degree heat of summer and downpours of winter. *Mariposa*—a summer resort stopover for Park travelers, a winter home for those who like to live in the mountains... but not too far into the mountains.

Where you find mountains, you find people clustered at their very base. *And where people build and live at mountain bases, people don't receive television!*

Early in 1953 an enterprising sole with good intentions but a poor head for business and even less experience with TV distribution systems amazed the people of Mariposa by "bringing television to town."

The enterprising sort had erected a set of questionable gain yagis on a hill 2,600 feet above sea level, and 600 feet above Mariposa. He purchased a set of single channel strip amplifiers, strung 4,000 feet of open wire line and tried to shove signals from channels 4 and 5, San Francisco, down the three-fourth mile open line to the valley town below.



MARIPOSA, CALIFORNIA. Isolated from the world by the Sierra Nevada range foothills, but a main stop for tourists on their way into Yosemite National Park from central California's San Joaquin Valley. 125 airline miles from San Francisco, elevation 2,000 feet. Surrounding terrain 2,500-4,000 feet.

The results were not spectacular. But television was television, and in this case "*any television was better than none*" so the people of Mariposa bought. They paid their \$100.00 hook-up fee, and then bartered with the system owner for a monthly fee that varied from \$4.00 to \$6.00, depending (apparently) on the color of your eyes!

The system was not well engineered. Ribbon line was used for main lines, feeder lines and drop lines. The amplifiers had no AGC, so you "*paid your money and took your chances.*" If you were fortunate enough to live near an amplifier (but not too close!) you received a strong but non-responsive signal. If you lived just ahead of an amplifier you received a goodly measure of snow, cross modulation, a little wiping on the weak channel from the strong channel (both of which varied at an irregular rate) and probably a half dozen ghost images due to mis-match on the line.

A few years passed. The twin line rotted, trucks snagged sagging feeder lines as they drooped lazily across main thoroughfares in the summer's hot sun and amplifier tubes went from poor to "resistive." Soon the customers quite paying their bills and the enterprising sort running the system decided Cable TV was a poor investment. He had tired of replac-

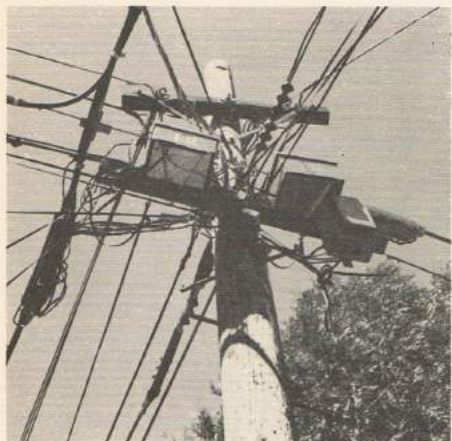

BEFORE—P.G.&E. owns the poles. An independent telephone company also uses them. But most of the mess is the product of the former owner of "Mariposa Television System." Two line amplifier boxes, with underslung power transformer, plus "a lot" of rotten twin lead going to and from amplifiers typifies the old installation.

ing torn down feeder lines, the electric company was threatening to remove his hazardous line and amplifiers from their poles and mountain deer were continually ripping out his open line between the hilltop site and his first "town amplifier."

He looked around for a sucker to unload the system on, and finally found his man. (*Exit present cast, ring down curtain on act one.*)

Your name is Robert Perry and you have always been a "bug on electronics." You hold a ham radio ticket, remember fondly the day when you built your first two-tube radio and mounted it on your bicycle. You attended college at Fresno State, a progressive California



BEFORE—Typical line box, with antiquated strip amplifier, pads and "sloppy wiring!"

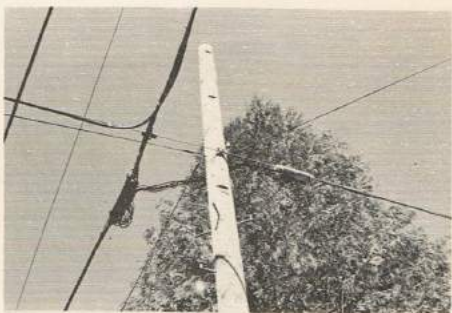

AND AFTER! Twin lead gone. Power transformer gone. Line amplifier boxes gone! *But, same pole.* Now all line amplifiers mount at the base of the poles, and 110 volts is "on the ground" as prescribed by law. Coax feeds the system, in place of the seven-year-old flat line.

institution of 7,000 plus students, majoring in speech arts. Upon graduation you broke down and took your *First Class Radio-Telephone* exam, passing it with flying colors. Then you went to work as a transmitter engineer for KSBW-8 in Salinas—soon deciding you didn't like the operation.

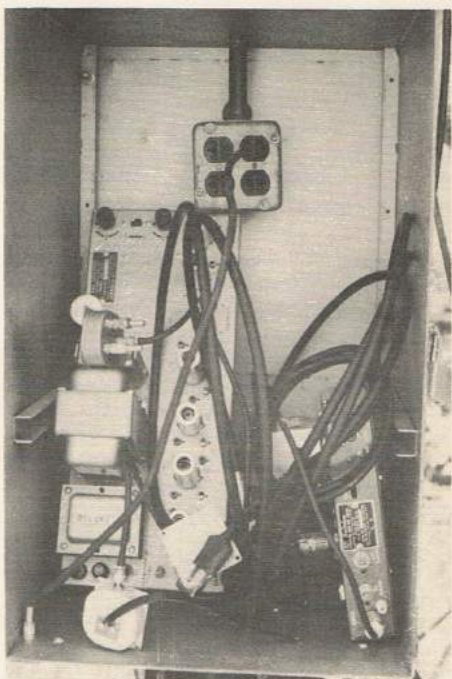

AFTER—Bob Perry comments "shelves for my equipment is my next job." *Blonder Tongue* MLA-B and *Jerrold* AOC *Cascade* make up the line equipment in this line box. Boxes are weatherproof, with power run in. Note lock on box, at right.

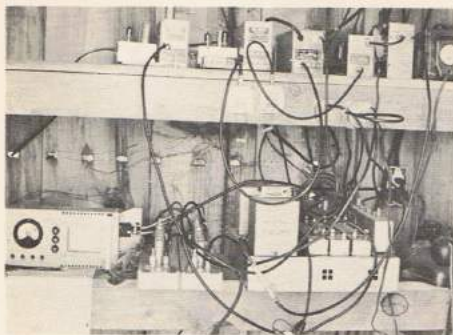

HEAD END—600 feet above Mariposa, 2,600 feet msl, Perry's head end shack cranks out the microvolts 24 hours a day. Channels 4 and 5 from San Francisco are fed into Jerrold 406A Amplifiers, and then into a Jerrold DPM unit. Channels 24 and 47 Fresno, are converted in old MA4-1 units (Blonder Tongue) which will be replaced by new MUC converters now on order.

Your next stop was Bakersfield, KERO-10. Located 7,000 plus feet in the air serving as a transmitter engineer had its advantages. You liked living away from the busy city life of Fresno (population 225,000), enjoyed spraying your 50,144 and 220 megacycle amateur signals around the state from such an advantageous location and found a great deal of peace and solitude in the healthy mountaintop climate.

But you still hadn't found what you were looking for. You didn't know it then but your frequent "holiday trips" into the Sierra's between Fresno and Yosemite would lead you to the very doorstep of our enterprising sort who in the close of act one was preparing to unload his "white elephant Cable system."

But soon you do work your way into Mariposa, on a day off, because you heard through the grapevine that a Cable System was for sale there. You talk with the owner, gag at the construction of the system but decide Mariposa has a great deal to offer. Besides, you are in no particular hurry. Suppose it does take you a few years to clean it up. In the meantime you can do what you most enjoy, journey to the many surrounding hilltop sites with your "Research Lab on wheels" (a 1960 Volvo now, which you find handles mountain roads like a sports car) and establish yourself with the residents of the area.

You buy the system. (Down comes the curtain on act two.)

MARIPOSA TV SYSTEM

Bob Perry runs a good clean Cable TV system. He does it on a limited budget, much

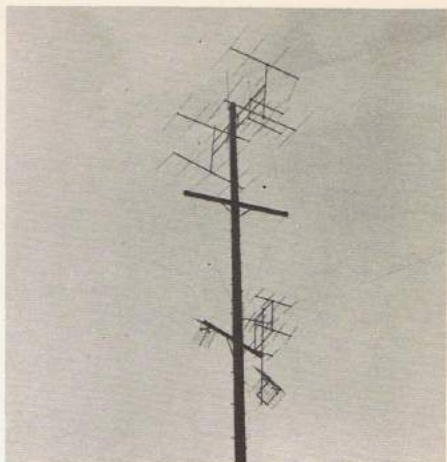

"TOP OF THE HEAD END"—60 feet above the top of Perry's television hill, yagis for VHF and corner reflectors for UHF scoop up the microvolts to feed the system. San Francisco is 120 airline miles, Fresno UHF transmitters "line of sight" over a 30 mile path.

of which is now going into equipment needed for the rebuilding process. Bob views his system as a long term investment. And he doesn't plan on stopping with Mariposa. *Not too much expansion mind you . . . but just a little!*

When Perry took over Mariposa TV, the set count had dropped from a high of 200 to the all-time low of 60. Most of the remaining drops were near the first amplifier, where signal levels and video response was best (?).

Bob soon found he had purchased more than a delapidated cable system. *He had also purchased a deadline!* The local electricity com-

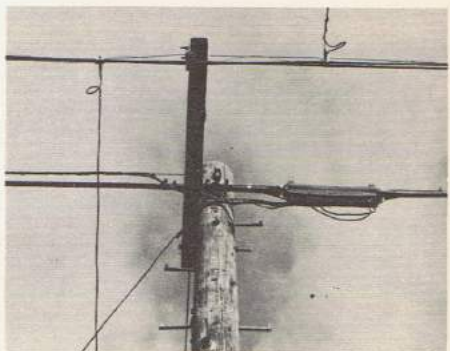

"HI-FI AND DRI" or so the advertisements read! Perry purchased his pressure taps in August, and reports he is very happy with the service rendered by the comparatively new Jerrold line tap-off. With 80 sets now on the system, these two drops represent nearly three percent of his total business!

pany was planning to take down a large section of poles which supported the "middle" of Mariposa TV's system. They gave him a deadline of 60 days to get his old lines off their poles or lose the entire section when the poles were pulled.

Working alone, Perry had to remove two miles of worn out twin lead, tear down 7 year old amplifier installations and keep the customers happy by replacing the old with new coaxial cable, AGC controlled amplifiers, "pressure taps" and matching transformers. As luck would have it, the "rebuilding" had to be done under the blistering heat of the long dry central California summer. 110 degrees in the shade was not uncommon, and both Perry and the new equipment got a real "hot workout."

Next job in store was replacing several miles of ribbon line. In many places the insulation was missing for stretches up to ten feet long! The old line amplifiers were running at full gain to push enough output to "brute force signal" to the next amplifier. Radiation was high and half the town merely pointed their antennas at the nearby distribution line passing their doors!

The town was not "television poor" but it was "television weak." The eastern portion of town (far edge of photo one) was high enough to receive a small amount of channels 24 and 47 from Fresno, direct. The west side of town, against the mountains, pulled a ghostly picture from channel 12 (now channel 30), also Fresno. No viewers really had an acceptable signal and few got more than a single channel.

Bob estimates there are 300 TV receivers in Mariposa. 80 of these are now connected on the Cable. Approximately 200 of the remaining 220 receive only KFRE-12, Fresno. As this is written, channel 12 is running dual on channels 30 and 12. By mid-March KFRE will close down the channel 12 transmitter and Fresno will become all UHF (with 24 and 47 already operating there).

Off the air checks already reveal that where the channel 12 signal drops into the western end of Mariposa the channel 30 signal does not. *By mid-March 200 television receivers will go dark or hook onto the Cable.*

Perry's *Mariposa TV System* is run with one thought in mind. Provide the TV viewer with a wide range of programs from both metropolitan (San Francisco) and local (Fresno) stations. From the antenna site, "Cable level



KJEO-47, FRESNO on the cable as channel 2.

signals" are available from channels 2, 4, 5, 7, 9, and 11 (San Francisco Bay region), 3, 10, 13 (Sacramento), 6 and 8 (Salinas-San Luis Obispo) and 24, 30 and 47 (Fresno). Perry's ultimate aim is to provide metropolitan programming from channels 4 and 5 (KRON, KPIX), which are now on the system, channels 24 and 47 for the local flavor (now on the system as 6 and 2 respectively) and adding a fifth station on channel 3. This channel, Bob says, will rotate around the remaining 10 stations to pick the program or programs his customers most want to see. In the spring, summer and fall seasons, major sporting events are often blacked out of the San Francisco bay region. In such cases, Perry says, he will switch to a station from a non black-out region and give his customers the event.

The idea is not a new one, nor is it uncommon in this part of California where hilltop viewers have a pickup of 10-20 TV stations. BUT is an excellent example of the "extra care" conscientious Cable operators build into their systems and Perry is off on the right foot.

Other future plans include "converting selected FM stations" to the region between 88 and 92 megacycles on the Cable. This will give the customers an opportunity to divide their tap off signal between a TV set (or sets) and FM receiver. Perry reports he has "swept" his pass band already and it is capable of handling signals up to 92 megacycles without degradation.

With the system in a rather dubious state of "status quo" when he purchased it, signal levels jumped around from set to set and were seldom "equal." As could be expected, using channels 2, 4, 5 and 6, the different levels

(Continued on page 21)

TRANSLATOR

Prepared monthly by
James Beamer*
P. O. Box 833
Livingston, Montana

TOPICS

LET'S QUIT DRAGGING OUR FEET!

The FCC and a goodly number of Senate and House representatives from western states are upset over the apparent procrastination on the part of Booster operators to file with the FCC Form 346—application for a construction permit (CP).

When the FCC on January 11 extended the February 1 filing deadline for VHF Booster operators to file Form 346, it was done with the expressed understanding that a real need existed for such an extension. It was felt and it is still felt that a number of VHF Booster operators simply were not equipped to complete their groundwork for Form 346 by the February 1 deadline. So rather than witness a wholesale avalanche of late filings the FCC graciously extended the filing date until April 1, 1961 (see *February DXing Horizons* page 12).

However, this extension is NOT an excuse for those operators who have completed their Form 346 groundwork to sit on their applications until the very last minute (i.e. late March).

If you are such an operator and are attempting to justify holding up your application by thinking "I want to wait to see what equipment is available in case I desire to change to another brand of gear before April 1," hear this brother!

You may file a "modification of application" at any time up to the date the Commission acts on your CP application. This means, simply, you may make a choice in favor of brand "X" coding equipment today, and change your mind to brand "Z" three weeks from now, IF you wish.

But this is NOT a justifiable excuse for holding back your Form 346 from filing! Get it into Washington today! A goodly number (about sixty percent) are being returned because operators have filled them out incorrectly. The odds are good your form will also be returned, at least once, before you get it straight enough for the FCC to accept. Wait no longer, get it into the mails today! You are merely prolonging what is bound to be a long wait anyhow. And like filing for an income tax refund, the longer you wait towards deadline the longer your Form 346 will take to move through the process line and back to you.

MANUFACTURERS

To quote a well-worn phrase of the Pacific Northwest, "they keep crawling out of the woodwork!" Since DXing Horizons went to press in late January, at least four (4) NEW confirmed manufacturers of VHF Translators have made themselves known. To clear the air and set the record straight, here are the new ones and a complete list of manufacturers now in this field.

*Secretary, National TV Repeater Association, Tri-State Repeater Association.

RCA, INC.

"One watt output on all VHF channels, unattended operation, will handle both monochrome and color" . . . sound familiar? It could be anyone of nine different units, but in this case it belongs to the Radio Corporation of America. RCA's TRV-1A is one of the most complete lines to come on the market. RCA includes, as "optional extras," transmitting and receiving yagis, Foamflex transmission line, a transistorized antenna mounting pre-amp and a choice of double or single conversion. We noted the AGC range is "within 2 db of rated output over a 30 db fade range." You can stack this up against other manufacturers on your own . . . we won't here.

The Model TRV-1A is the single conversion model, for converting low band channels (2-6) to the high band (7-13) or vice versa. The double conversion TRV-1A2 will convert within the high band, or low band and as might be expected, it costs a little more. Base price on the TRV-1A is \$1,995.00, with the code identification keyer "extra" at \$195.00.

The Model TRV-1A2 is priced at \$2,450.00, also minus identification keyer (also \$195.00).

RCA reportedly does not wish to market its unit to Translator groups, but rather to broadcasters who will install VHF Translators.

TEPCO

TEPCO, a product of "Telson Electronic Products, Inc." of 320 E. Blvd., Rapid City, South Dakota (this town may soon become known as the "Translator capital of America") was also originally intended for use by the broadcasters themselves, rather than individual towns or TV co-operatives. Heading up the company is Elmer Nelson, chief engineer at KOTA-TV Rapid City, and Technical Director of KOTA satellite KDUH. President Nelson reports "Our Translator was officially turned over to the FCC for type acceptance February 3, 1961." Nelson notes "TV Clubs in the immediate area have given us several firm orders and this prompted us to send out feelers to other cities. The interest is very good." Although not official (from Nelson), the TEPCO unit is understood to be priced around \$1,100.00, complete.

INTEC, INC.

Intercontinental Electronics, Corp. is a recent entry into the field. No one will admit to having seen an INTEC unit to date, although some literature has been circulated. One Idaho group was understood to be negotiating with INTEC to supply all of the Idaho Translator Association's needs (see this column for February). This however is not confirmed. Price is believed to be in the neighborhood of \$1,800.00 per one watt unit. You can flood the company with mail at 300 Shames Drive, Westbury, L.I., New York.

(Continued on page 16)

From the **HEART** of North America

MID AMERICA RELAY SYSTEMS

RAPID CITY, SOUTH DAKOTA



Announcing
Around the Clock Service

ONLY HOURS BY AIR FROM YOUR TRANSLATOR!

***STILL ONE MORE REASON WHY YOUR BEST BUY
IN VHF TRANSLATOR EQUIPMENT IS M.A.R.S.!**

Although component failure is RARE in MARS equipment, *Mid America Relay Systems'* engineers recognize the need for maintaining a factory service department *24 hours a day, 7 days a week!*

When equipment failure occurs, and it cannot be remedied by tube replacement or field servicing, the MARS factory ser-

vice department is ready, willing and ABLE to put you BACK ON THE AIR!

The MARS RX-17B, now *FCC Type Accepted*, is compact and light (weighs less than 50 pounds). So light, and so compact that we in fact recommend you return the unit to Rapid City for factory alignment and repair with precision instruments.

OUR GUARANTEE OF QUALITY

Use the Model RX-17B VHF Translator for ten days . . . if this equipment does not give you increased coverage, improved video and audio, as well as improved AGC stability, return the unit to Rapid City for a full cash refund!

Place your order now with *Mid America Relay Systems*, the oldest VHF Translator manufacturer in the U.S.A. (since 1954)! *Write today for full details.*

MID AMERICA RELAY SYSTEMS, INC.
601 Main Street
Rapid City, South Dakota

TRANSLATOR TOPICS

(Continued from page 14)

EITEL

George Eitel, President of Eitel Electronics, P. O. Box 1887, Prescott, Arizona wants it known he placed his data into the lap of the Commission on January 25. Eitel notes "we originally filed our papers on September 12, 1960, some two months prior to any other firm. Then we contemplated changes in the basic unit (Model VHF-TR10/1) and asked the Commission to hold up passing on our equipment until we finished revision work." Eitel's unit sells for an even \$1,000.00 delivered and features a unique APC (Automatic Power Control) which samples the power output through a diode, "senses that output" and adjusts the final output level through the AGC level on the driver stage. Result? One watt output at all times, even as the tubes age. George Eitel reports he is accepting orders at this time.

VHF TRANSLATOR MANUFACTURERS— EQUIPMENT STATUS

Manufacturer	Unit	Approval/ Status	Price
Adler	VST-1	Pending	\$2,100
Benco-Blonder Tongue	T-1	Approved	\$1,875 apprx.
Eitel	VHF-TR10/1	Pending	\$1,000
EMCEE	HRV	Approved	\$1,195
GEM	GEM-1	Pending	\$995
INTEC	---	???	\$1,800 apprx.
MARS	RX-17B	Approved	\$1,095
	1/3 watt unit	Pending	Under \$500
TEPCO	---	Pending	\$1,100 apprx.
RCA	TRV-1A	Pending	\$1,995

PRODUCT —

LOOKING FOR A MANUFACTURER

H. R. Medland, Sales Engineering Supervisor of the Automatic Timing and Controls Company, "King of Prussia, Pennsylvania" inquires "We are manufacturers of timers and have an interesting design for the Morse Code programmer required for VHF Translator identification. Anyone interested?" (Contact Mr. Medland, NOT DXing Horizons.)

MARYLAND TRANSLATOR

R. L. Bigler of Cumberland, Maryland writes "We have mountains here in Maryland too! A little over two years ago, by public donation, we put on the air three Adler UHF Translators. We cover about one-third of the town. There is also a Cable system in town. However there are still areas of town not covered by either UHF or Cable. We have filed with the FCC to receive off the air from our channel 80 UHF Translator and rebroadcast on channel 8. The signal starts on channel 7 in Washington.

Midland, Maryland has also raised \$3,500 from 150 families there and they plan to put on three VHF Translators, if the first works out OK."

Not to throw a damper on your enthusiasm Mr. Bigler, the FCC has been hesitant to grant VHF units in areas already served by UHF Translators.

In fact, they are considering a new type of UHF On Channel Booster for areas just such as yours. Nonetheless, we wish you luck!

NEBRASKA FORMING

TRANSLATOR ASSOCIATION

The first Translator Association in a "Plains State" may soon be an established fact. Jerry Warfield, of Scottsbluff, reports he will soon be calling a meeting of all Nebraska Translator operators to meet and talk over the advantages of a state association. FCC records show there are approximately 70 VHF Translators in the state.

WE ALL SLIPPED UP!

On November 16 the Broadcast Bureau issued a notice which said, in effect, every new applicant or present owner-operator of a broadcasting type station must publicize his intentions to file for or make a major change in that station for a period of two weeks following the filing of his application with the Commission. Without explanations as to why this must be done, let us accept it as a fact and act accordingly. Hereafter, if you are filing for a new or modified VHF or UHF Translator license, keep in mind the following:

(1) In a local newspaper publication at least twice a week for the two weeks immediately following the filing of an application, you as the applicant must advertise "your full intent" and all of the details of your application.

In short, you must notify the residents of the region to be served by the new Translator that you are filing with the FCC an application to "fill the airwaves" in their region.

This is done to give residents the full opportunity to appeal your application should they so desire. If this sounds like so much more bureaucratic paperwork, DXing Horizons advises you do as required. Several groups who filed their Form 346's of late have, through ignorance of the new law (which went into effect December 12), been called on the carpet by the Commission and the processing of their 346 forms held up an extra two weeks or more. Act accordingly and keep the carpet clean!

MONTANA BOOSTER BILL

House Bill number 310 in the Montana Legislature has passed its first hurdle. The bill, backed by the Tri State TV Repeater Association, would create special improvement districts for TV Translators, with a "use tax" to be levied against TV set users in the area served by the Translator, BUT only those actually using the Translator signal (would not tax Cable viewers, off the air viewers, etc.). The bill passed the Montana House 67-22 with amendments proposed by Montana broadcasters and Cable operators voted down.

Next month DXing Horizons will review in detail six "different Tax District approaches" to the TV Improvement Area question. Bills are now in the works in Oregon, California, Colorado, Idaho, Wyoming and Montana. Utah and Nevada already have enacted such laws.

MARS CAPTURES IDAHO

Still not official, but Rex Shirts of the Idaho TV Repeater Association notes "it appears that Mid America Relay Systems will provide all of the units (VHF Translators) to the Idaho operators." Idaho Translator ops, as reported last month, joined forces to "buy as a joint power" in order to

(Continued on page 20)

ANOTHER FIRST FROM GEM

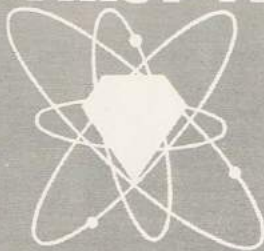

RADIO REMOTE CONTROL FOR YOUR TRANSLATOR!

GEM ELIMINATES

- Expensive undependable wire (landline) control.
- Costly-time consuming trips to the site to shut down the Translator.
- Long delays in obtaining your construction permit (CP) or final license while the FCC investigates your ability to shut down the Translator on 15 minutes notice.
- Expensive-complex approaches to radio control.

**The Complete GEM-1 VHF Translator is Priced at \$1,095.00
WITH RADIO REMOTE CONTROL!**

The new GEM-1 VHF Translator is simplicity through and through!

YOU SAVE ON

- Initial cost (lowest in the industry).
- Maintenance costs (as low as \$50.00 per year).
- "Add on costs" (up to three VHF Translators may be controlled by a single radio remote control unit).
- Filing costs (GEM will file Form 346 for you . . . no charge!).

YOUR GEM-1 VHF TRANSLATOR IS FULLY GUARANTEED

Satisfaction or your money back!

Contact General Electronic Manufacturing TODAY and let us help you plan your new or modified VHF Translator

DO IT RIGHT FROM THE START . . .

with foolproof radio remote control at a price lower than units without radio control!

WANTED—Qualified responsible sales personnel to represent GEM, INC. in your area.

GENERAL ELECTRONIC MANUFACTURING, INC. (GEM)

POST OFFICE BOX 865 • ROSEBURG, OREGON

GEM, Inc.—From the Land Where People Know Translators Best...The Pacific Northwest

A FIRST! FCC-Type Accepted*

EMCEE VHF TRAN

Selected for Custom Design, Easy Installation

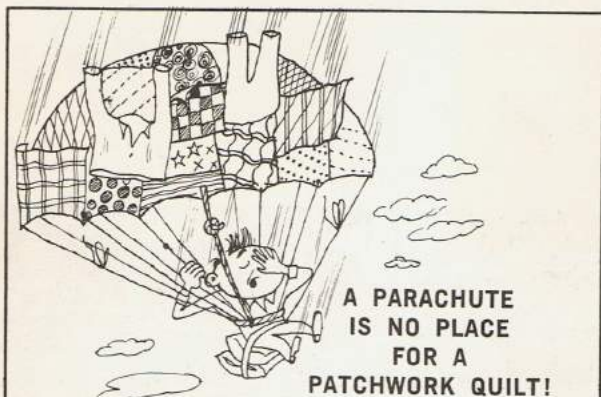

A PARACHUTE
IS NO PLACE
FOR A
PATCHWORK QUILT!

When performance counts . . . you don't dare take a chance on a rag-tag, put-together concoction. Then why settle for translators that "make-do" in a "jerry-built" fashion with sub-assemblies "swiped" from cable systems. Many translators earn FCC type approval...but that's where the similarity stops. NOW investigate the vital features ONLY the EMCEE Translator can give you.

EMCEE TRANSLATORS operate at maximum efficiency because EVERY CIRCUIT is specially designed and integrated and every component is specifically engineered and precision made for this particular translator. No "lash-ups"! No forced fits of existing products! Dependability and reliability are actually ENGINEERED into each section so that all parts and circuits work with each other to perfection assuring long years of maintenance-free performance.

TRANSLATORS MAY BE RUN IN TANDEM TOO!

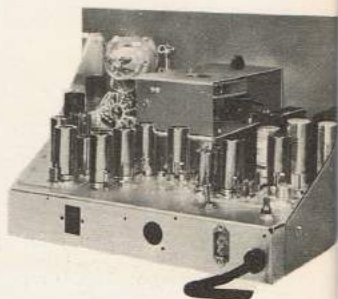

T E C H

Input: Down to 50 Microvolts
A.G.C.: 30 db input variation
from 50 microvolts to 50,000

Output: 1 watt with no measurable distortion
Mountings available: 8 3/4" rack

- **Model HRV**
Complete FCC-Type Accepted VHF Translator.
- **Model UHRV**
Same as Model HRV With UHF Input Included.
- **LEGALIZER**
For existing installations...provides 1 watt output...automatic on-off and identification...makes compliance with FCC rules easy. Factory measured electrical characteristics minimize field measurement. Exhibits included with equipment simplify filing FCC forms.

ELECTRONICS, **M**IS

262 East Third Street

SLATOR

& Top Performance!



DESK CABINET MOUNT

TECHNICAL DATA

on 75 ohm line.
produces less than 1 db output variation for signals
microvolts.

able sync compression; 50 or 75 ohms.
or cabinet; self-contained outdoor housing available.

EMCEE DOUBLE CONVERSION VHF TV TRANSLATOR

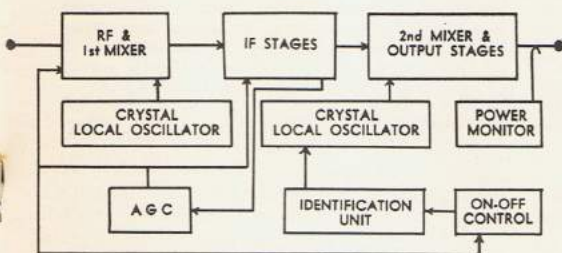

ELECTRONICS AND COMMUNICATIONS, INC.

• Mount Vernon, New York • MO 8-3012

See us at the
**SALT LAKE CITY
WESTERN TRANSLATOR
CONFERENCE
MARCH 3-4, 1961**

The big story is in trade publications coast to coast! NOW...the new EMCEE VHF TRANSLATOR becomes the FIRST** TYPE ACCEPTED BY THE FEDERAL COMMUNICATIONS COMMISSION! This stamp of approval is further assurance of quality results never before obtainable in commercial translators. Now read the facts that mean faithfully-rebroadcast color and black and white signals in your community - all on a new channel that won't interfere with direct reception in overlapping areas!

- **CONVERSION FLEXIBILITY**... any input channel to any non-adjacent output channel.
- **FREEDOM FROM INTERFERENCE**... no internal signals which coincide with input to any other translators.
- **EASY OPERATION UNDER FCC RULES**... simple control and identification unit minimizes maintenance and reduces cost... no operator required.
- **EASY-INSTALLATION**... available for cabinet/rack mounting or in weatherproof housing.

DEALER INQUIRIES INVITED

Factory-trained local organizations are available for assistance in most translator areas.

FREE
reprint of
FCC rules
covering
translators

ELECTRONICS, MISSILES AND COMMUNICATIONS, INC.
262 east third street • Mount Vernon, New York M

- My community needs better television. Please rush free planning package including data sheet, complete installation check list, coverage calculation form.
- UHF input
- LEGALIZER for existing installations
- Please send free reprint of FCC rules covering translators.

NAME _____

ADDRESS _____

CITY _____ STATE _____

CORNER REFLECTOR ANTENNA

(Continued from page 5)

of galvanized pipe should be at least 1.25 times as long as dimension A (for the channel in use) from table one. With the feedline connected to the dipole and the dipole mounted in place, turn on the transmitter and position a group of "off the air" observers across the area you are trying to cover with the translator signal. Slowly move the galvanized pipe vertically in, and then out, closer to and then away from the screen reflector. Your observers will tell you when the translator signal is best (via landline or radio control we will assume). You are searching for the "gain point" on the antenna, where the dipole mounted in front of the screen is in phase with the screen, and the antenna shows maximum gain and the best pattern for your coverage area. *Up to a point you can adjust the broadness of the pattern through this simple focus adjustment of the dipole in front of the screen.*

COMMENTS

If your VHF Booster has been plagued with "holes in the coverage pattern," ghost signals and downright poor coverage for your one watt of power, you will probably find this antenna just the ticket. There is no better time than right now to begin the construction work on your "Corner Reflector Transmitting Antenna" to assure it will be ready for mounting when the snow clears off the peaks and "mountain topping weather" arrives for the '61 Translator Season!

TRANSLATOR TOPICS

(Continued from page 16)

get the best price. The money saved will be used to finance the engineering behind the 40 odd units now operating in the state. MARS' new one-third watt unit reportedly had a great deal to do with the decision to use MARS gear over other equally impressive lines.

TRI-STATE OFFICIALS RE-ELECTED

... Your Editor Gains An Aid!

At a recent meeting of the Tri-State TV Repeater Association, all of the present officers were re-elected to serve an additional term in office. Mrs. Dorothy Spannagel, Secretary of the Howard TV Club in Forsyth, Montana, was named to the new post of Assistant Secretary, to work with your editor. Other officers re-elected included Mike Barrett, Vice President for Idaho, LeRoy Abel, Vice President for Montana, Darwin Hillsberry, Vice President for Wyoming. Fred Becker, Circle, Montana was re-elected President, and your editor as secretary.—J.B.

WESTERN FRINGE NEWS

SALT LAKE CITY — CASPER

... Scene of Booster Hearings

Senator John O. Pastore (D-R.I.), Chairman of the Communications Subcommittee of the Senate Interstate and Foreign Commerce Committee directed a session of "follow up Booster Hearings" in the west February 21 and 22. A federal question team headed up by Senator Dale McGee (D-Wyo.) appeared in Casper on the 22nd, and Salt Lake City on the 21st. The purpose of the hearings as announced by the Committee, was to "ascertain if further legislation is needed on a Federal level to assure television service for small communities in the west."

A full report in April.

BLOOMFIELD, NEW MEXICO

... Hearing Set for March 28

Bloomfield (New Mexico) Translator Club will have the opportunity March 28 to defend its "after July 7 Booster installation" against charges filed against it by the Aztec (N.M.) Community TV System. The hearing will be held in Bloomfield with an FCC hearing officer presiding.

NEW LOW-POWER TV

... For Lamar, Colorado and Gallup, N.M.

The FCC has granted Televents Inc. of Dallas a pair of low-power TV station CP's for the Rocky Mountain area. The Commission OK'ed a request for a 389 watt station on channel 12 in Lamar and a 933 watt station on channel 3 in Gallup. Televents is owned by Bill Daniels, Winston L. Cox and Carl Williams. All are active in the CATV field throughout the west.

A REAL CATV SUCCESS STORY

The NCTA bulletin for February 6 reports on the rapid growth of a New Mexico CATV system. Brown Walker, Manager of Cable TV of New Mexico (in Roswell) began making drops on his system in August of last year. By January 1 he had 2,200 connections! The system also provides free TV (via Cable) to all of nearby Walker Airforce Base and includes to date 115 miles of cable.

STATION SALES... In the West

The FCC has granted transfer of ownership of KNDO-23 Yakima to Columbia Empire Broadcasting Corp. This is essentially a purchase from owner Ralph Tronsrud by the station employees.

The Commission also approved the purchase of KIVA-11 Yuma, Arizona by Bruce Merrill, owner of numerous CATV interests in the southwest.

NBC CHANGES COLORS

... Indefinite Stay Granted to Boosters

The National Broadcasting Company has reversed its "affiliates permission ruling" for VHF Boosters. Under the old ruling Boosters using the programs of NBC stations needed NBC permission to rebroadcast the material through Boosters, prior to February 1, 1961 deadline. NBC, in a news letter to affiliates January 24, told its affiliates "in light of the Commission extension of the February 1 deadline for Form 346 to April 1, NBC agrees to extend the waiver period until the Commission finally sets for submission by pre-existing repeater stations, applications for conversion to conform to the new low-power VHF Translator rules."

In short, don't worry about a deadline for NBC permission.

**"From above
the trees..."**

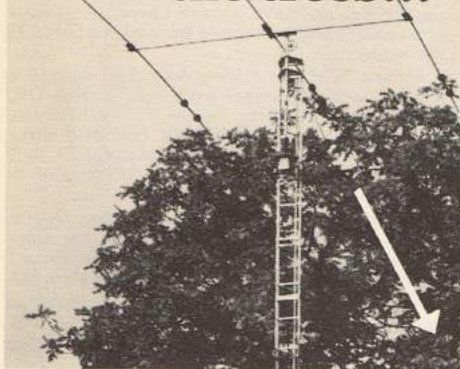

CABLE DROP

(Continued from page 13)

caused a good deal of adjacent channel hash. Perry has now balanced out the line levels to maintain 1,000 uV on all Cable channels. His channels 4 and 5 received signals measure 300 uV at the antenna before amplification. Channels 24 and 47 are line of sight and signal is no problem here . . . *except perhaps too much of it!*

Bob is currently experiencing a minor power leak problem apparently caused by a cracked or missing insulator on a pole "someplace in town." The noise is not severe enough to markedly degrade the video signals on the Cable but Bob is a perfectionist and he was quick to point it out to *DXing Horizons'* roving reporter as we spot checked a few Cable signal receivers. So far the power company has been less than cooperative in fixing the "leak."

Perry's antenna site is a wooden shack, located in the middle of a sheep pasture. While the menagerie has not bothered his equipment, the dirt track road to the peak crosses his "landlord's land" and the "old fellow" has been known to change the padlock on the gate after a heavy rain so Bob won't venture across the field with his Volvo. The walk to the top is not a long, nor particularly hard one. But it can be annoying in a down-pour when a component breaks down and demands immediate service. Bob holds a 99 year lease on the hilltop.

Like all good *DXing Horizons'* readers, Perry has tried out the 6922 in the front end

of his equipment. Bob reports he substituted the frame grid tube for the 6BQ7A on one of his channel four amplifiers and after some modification decided all he probably gained was additional tube life.

Mariposa TV System charges \$5.00 per month for use of the antenna system, and a \$25.00 hookup fee. Bob notes "I won't get rich overnight, but I like living here and have my eye on a nearby 4,000 foot mountaintop for a home someday. The people are nice and friendly and all very helpful. With channel 12 going off the air I know I can prove to the holdouts (220 or so) that the new Mariposa TV System is a great deal changed from the former ownership. Now if I can just handle all of the orders in the next sixty days, we will be OK!"—R.B.C.

(Continued on page 22)



**Leave the Tower up . . .
and bring the Antenna down!**

Amazing KTV Hy-Track Tower

"You Crank the Antenna Up the Tower"

PERFECT FOR

Research • Antenna Testing • Survey
Work • VHF-UHF commercial or private
receiving-retransmitting applications.

LOW COST!

Write for Details Today

**KTV Tower and Communication
Equipment Company** Dept. D

P. O. Box 294 • Sullivan, Illinois

DX-ing HORIZONS
recommends

Amperex
Ampliframe
FRAME-GRID TUBES

for
**MAXIMUM
TV DX**

As reported in the July, 1960 issue of DXH: "... Greatly improved audio..." "... Video lock-in range extended... to nearly 300 miles..." "... Identifiable audio with any signal that barely comes into sync..."

These gain-improvement advantages are the result of IF and tuner conversion with these Amperex Ampliframe tubes... 6EH7/EF183 • 6EJ7/EF184 • 6922/E88CC • 6DJ8/ECC88 • 6ES8 • 4EJ7/YF184... available at your local radio parts and ham distributor.



ask Amperex
about AMPLIFRAME tubes
for DX applications

Amperex ELECTRONIC CORPORATION
230 Duffy Avenue, Hicksville, L. I., N. Y.

CABLE DROP

(Continued from page 21)

BILL TO REGULATE CATV

... Goes to Congress February 17

The FCC on February 17 handed to Congress the ingredients for a "blank check" it seeks to write over the opposition of the nation's Cable TV operators.

DXing Horizons readers were first warned of this bill in the December issue (see "At Sign-Off," page one, December) when this publication's Washington news desk learned that ex-chairman Ford was planning a "death blow to CATV operators" as one of his last acts as chairman of the Commission.

In the February DXing Horizons we reported on the actual release of this proposal for public consumption, when the Chairman spoke before a gathering of CATV operators in Washington, D.C.

Now we must report that our "early warnings" have proven truthful.

Essentially the bill boils down to these points. The FCC does not seek regulatory control (such as the PUC now holds over landline communications and power companies) over ALL CATV systems. In fact the FCC has ruled out of its scope of operation all CATV systems with fewer than 50 subscribers and those essentially in motels, hotels and apartment buildings.

But, the Commission does seek the power to step into disputes between CATV systems and broadcasters. The Commission has stated it feels "that as the broadcasters are under federal regulation and must conform to strict rules of operation, any direct competition afforded to the licensed broadcasters (i.e. CATV) should also be under the direct control of the Commission if the Commission is to adequately protect its licensed services from unequitable economic competition."

In capsule form, the bill introduced into the Congressional hopper would give the FCC power to, "at its discretion," decide which of the nation's 900 plus CATV systems "need the guiding hand of Uncle Sam." Under full intent of the bill the CATV operator unfortunate enough to come under the scrutiny of the Commission would be virtually assured economic sanctions of sufficient scope to greatly reduce the possibility of his remaining in business.

NCTA MEMBERSHIP DRIVE

... Raising a Head of Steam

The National Community Television Association has of late been engaging in a membership drive to bolster its ranks of representation for the nation's Cable TV operators. One of the frequently heard war cries is "join now and help us save YOU from Federal regulation." Recent NCTA bulletins report the drive has been successful and it appears the Cable operators will present an even more united front than in 1960 against the threat of regulation.

IN MAY...

When DXing Horizons changes to TELEVISION HORIZONS, an expanded technical section for distribution television... SPREAD THE WORD!

RADIO CONTROL FOR TRANSLATORS

(Continued from page 6)

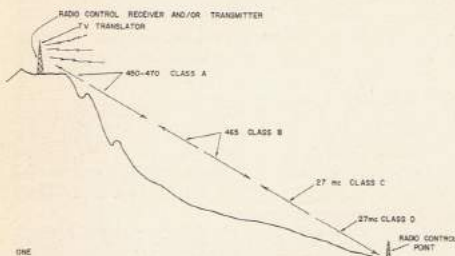

chances for interference are great and it is very possible that signals from Class C and D stations 500-several thousand miles away will trip your radio control receiver on your mountaintop and shut down your Translator! And no matter how many times you re-activate the Translator, it may shut down again when the "skip" signal(s) returns to the air. There are ways of curing this problem but they can be expensive. And the frequent "shutting down" of the equipment could be a "little annoying" not to speak of being rough on the components. DXing Horizons therefore recommends that you give more than passing thought to the type of radio service you establish for remote controlling your Translator.

SPECIFIC REGULATIONS — CITIZENS RADIO SERVICE

The following observations apply to all classes of Citizens Radio stations. Such stations may not be used for the transmission of any type of program material or to carry any type of communications for hire. The radiation of continuous carriers is forbidden as are unnecessarily long or repetitious transmissions. No authorizations will be granted by the FCC where it appears the Citizens Radio station is to be used in connection with unauthorized or unlicensed stations. Citizens Radio station licenses may be obtained for use in connection with Translator stations either before or after the grant of the Translator station authorization. However, such a grant shall not be construed as a commitment by the Commission that the Translator application will be granted. The licensee of the Citizens Radio station must retain control of the operation of the station at all times. Such authorizations may be issued to either the licensee of the Translator station or his agent or to his service engineer, provided in the last two cases (agent or service engineer) operational control of the Citizens Radio station remains in the hands of the agent or service engineer.

AND . . .

Citizens Radio stations are licensed with the expressed understanding that they will receive no protection against interference from stations legally operating in the same or other radio services.

Remote control of the Citizens Radio station by radio, when the station itself is used to remotely control a TV Translator station is not permitted. In other words, remote control of the remote control unit is forbidden.

FORM 505

FCC Form 505 is required when applying for a new, renewed, reinstated or modified license in the Citizens Radio service. All of the Commission's Engineering Field Offices stock Form 505. Complete application instructions for Class A, B, C or D stations are attached to Form 505.

A complete set of the rules governing the operation and licensing of stations in the Citizens Radio service is provided by the Government Printing Office, Washington 25, D.C. Ask for "Volume VI, FCC Rules and Regulations" when ordering. The cost of this volume is \$1.25.

This series will be continued in subsequent issues of DXing Horizons with a report on actual Translator licensees now using varying forms of Citizens Radio service for remote control as outlined in the preceding material.

FRESNO UHF MOVE ...of National Interest

As reported elsewhere in this publication, the February 17 move of Fresno VHF channel 12 station KFRE to UHF channel 30 is now underway. Fresno is currently a three-station market with KMJ-24 and KJEO-47 operating. With the move to channel 30 by KFRE, Fresno assumes an all-UHF status.

The voluntary move by the Triangle Publication's station KFRE is of prime interest to the broadcast industry (both receiving and transmitting) for a number of reasons. First of all, KFRE moved without a fight. It did so with speed and dignity.

Secondly, first reports from the field indicate that with only a few exceptions in remote Sierra Nevada mountain range towns, the new 1.39 million watt UHF signal on channel 30 is every bit as strong if not stronger than the 316 kw. VHF signal.

In the May issue of TELEVISION HORIZONS, an intensive field survey now underway by DXing Horizons will report on the apparent technical success or failure of the nation's first voluntary move to the ultra high range.



ANTENNAE SYSTEMS

GET MORE FM STATIONS WITH THE WORLD'S MOST POWERFUL FM BROADBAND ANTENNAE

To be fully informed, send 30¢ for NEW Edition of "All About FM Antennae and Their Installations" by L.F.B. Carini. Contains Directory of FM Stations and Log.



FM/Q WETHERSFIELD 9, CONN.

For DXers Only

(TV and FM DX reports from DXing Horizons readers. The editors welcome reports from avid DX fans and readers who are for the first time discovering the "long distance capabilities" of the television and FM broadcasting ranges. Reports to appear in April must be received prior to March 16, 1961.)

MOSTLY TROPS . . .

DX enthusiast Rod Luoma of Detroit, Michigan, is a more enthusiastic than average long range TV enthusiast. Luoma is a technician at Detroit's WJBK, where he is personally in charge of checking over DX reports and issuing "verification cards."

THIS WILL VERIFY YOUR RECEPTION OF WJBK-TV CHANNEL 2, IN DETROIT AT _____ EST. ON _____ DISTANCE _____ VERIFIED BY _____	ERP: 100 KW VISUAL 50 KW AURAL TOWER: 1,057 FT. TRANSMITTER LOCATION: 9 MILE & SOUTHFIELD RD. SOUTHFIELD, MICHIGAN
---	---



Luoma reports he has been monitoring UHF channels 72 and 76 daily for signs of the "flying educational stations" due to begin operations over Indiana in late January. "To February 10, no reception" reports Rod.

Luoma's checks on the UHF band did net him some unusual long range UHF hauls for mid winter however. "No repeat of last year's big fog session of late January-early February, but definitely unusual."

January 16 found Luoma's 12 bay Taco Bowtie intercepting signals from UHF stations west to Wisconsin (WMTV-33, 325 miles) and southwest to Illinois (WIC-20, 375 miles) as well as many closer to his location. Luoma also found UHF signals peaking up out to 200 miles at various hours on February 6, 7, 8 and 9.

DXer Luoma uses a 1960 Satchell Carlson receiver, Winegard WBC-4 amplifier and four (4!) Jerrold Trap Eases to aid his DXing.

Terry L. King DXes from San Angelo, Texas, with an EV Booster, Magnavox receiver and stacked all channel yagis 60 feet high. On January 23rd King caught WTHS-2 Miami between 1645 and 1800 EST (1400 miles). Troops brought signals from Arkansas (KTVE-10) January 28, and Louisiana (KSLA-12) February 3rd.

DOWN UNDER . . .

Robert Morse DXes the video bands from Auckland, New Zealand. His DX set up was reviewed in these pages in May 1960. Morse reports the past summer (south of the equator that is) has been a "poor one for DX reception from Australia" his closest DXing target area.

Australia low band channels were recorded on only five occasions during the DX season, with December 23rd the best date. Morse sends along a photo of ABQ-2 Brisbane (1700 miles) taken that afternoon when a Cricket match was in process between a West Indies team and Australia. January 21 and 22 also produced Australian signals with ABQ-2 seen the 21st, and ABN-2 from Sydney seen the 22nd.

Morse notes "local television" is now broadcasting 21 hours per week in New Zealand, but only on low power as the people of the local city region won't allow the station to build an antenna tower on top of the only suitable hill in the area. They say it will create an eyesore!



TV DXer Gary Olson

DXH reader Gary Olson of Barrington, Illinois is one of the more alert young DXers in the country



Olson's DX Den

today. Olson's DX hobby has netted him 178 stations, 27 on UHF. 168 of these stations are verified. His best catch is KTVK-3 Phoenix, Arizona over a 1460 mile path.

(Continued on page 26)

The DX Enthusiast

By
Gordon E. Simkin
Idaho Falls, Idaho

George runs a TV service shop. One of his pet hobbies is improving deep fringe TV reception. George's young admirer, Jim, is a TV DX enthusiast of recent vintage and he has a lot to learn! George's TV shop is the scene.

Evaluating a TV Receiver for DXing

"Here Jim, my favorite type of tuner . . . the Turret Tuner." George turned the small metal chassis slowly over and pointed to a trio of tubes.

"This tuner has three tubes. The tubes are a 6AG5, 6CB6 and a 6J6. The 6J6 is the local oscillator and this 6CB5 is an amplifier . . . in fact it is the first amplifier. Its known as the radio frequency amplifier, or R. F. stage. And then this 6AG5 is the . . ."

"Mixer!" Jim interrupted. "It must mix the signal from the R. F. stage and the local oscillator. But why?"

"Say, you're getting pretty sharp" answered George. "But I'm not going to answer your question . . . at least not now."

"What next then George?"

"NEXT . . . let's finish what we started! I want to show you why a great deal of snow on the screen does not necessarily indicate a set with lots of gain."

"Here" indicated the shop owner pointing to a string of tubes and transformers in a row on the receiver chassis. "This is the I. F. string . . ."

"String?" quizzed Jim.

"I mean a string of tubes, together. Actually we

have four I. F. tubes here, all tuned to the same frequency. In this case the I. F. frequency is 21.50 to 27.50 Mc. The sound carrier is at 21.75 Mc and the video is at 26.25 Mc."

"But George" started the younger lad, "if this I. F. doesn't change and isn't tuned to a TV channel, how can it do any good. And I thought the sound was ABOVE, not below the video carrier?"

George smiled and pulled down his notebook and a pencil. "We need a drawing and a basic principal to clarify your questions. Our principle is this. When ANY two radio frequency signals are MIXED, we end up with four different frequencies. We still have both of the original frequencies, and also the sum and the difference frequencies. Let me diagram this for you."

George drew the diagram in figure 2A and proceeded to talk about it as he drew the outlines for figures 2B, 2C and 2D.

"Jim, this (figure 2A) is sort of a formula that visually explains what I said. Let's say F1 is our local oscillator and F2 is the TV signal. Now what is the frequency of a channel 2 sound carrier?"

Jim quickly replied "Isn't it just under 60 megacycles?"

"Yes, 59.75 Mc to be exact. Substitute that in place of F2 over here (figure 2B). Now write 81.50 for F1. Just fill out the rest of figure 2B by drawing in as the formula indicates.

Jim finished filling in figure 2B. "Hey, this figure here, 21.75, is the sound I. F. frequency you gave me!"

"Right Jim Now change F2 to 55.25 for the channel 2 picture and complete the diagram again." Jim did this in figure 2C.

"Well of all things! I get 26.25 megacycles, and that's what you said the video I. F. would be!"

"At this point Jim let me illustrate what I said before. This local oscillator is on 81.50 megacycles (F1 in 2A). Where is the channel 6 video carrier?"

(Continued on page 26)

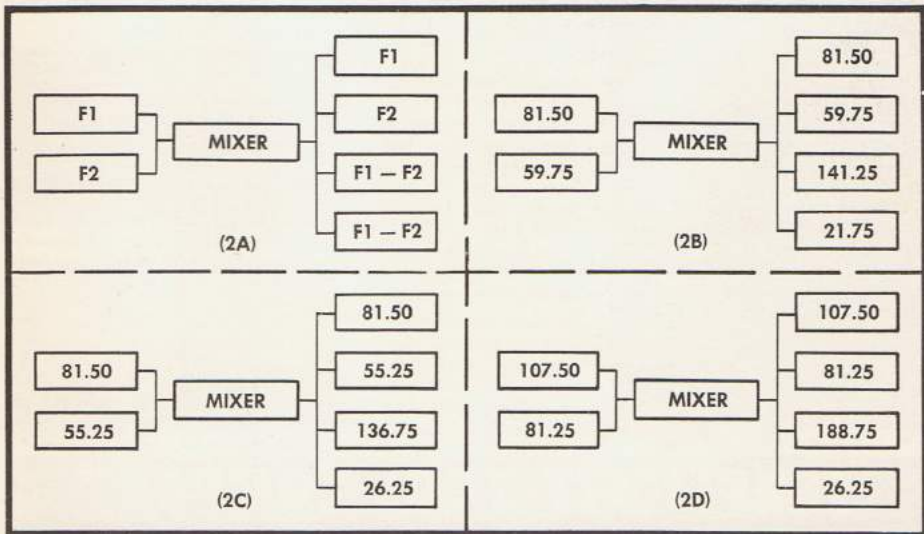

FIGURE 2

FOR DXers ONLY
(Continued from page 24)



KTRK-13 HOUSTON. Logged in April 1960 on "Gulf Troops" by Don Ruland, Holly Hill, Florida. Watch for this type of Troops in April!

FORECAST . . .

DXers in the Gulf Coast region . . . look out! This is THE time of year (through mid April) when both low and high band signals begin to slip beyond fringe areas into the 700-1,000 mile range.

Late evening and early morning hours will be best. Florida DXers, watch for KGUL-11 and KTRK-13 Houston as the first signs of DX Conditions. Texas DXers . . . just watch!

THE DX ENTHUSIAST

(Continued from page 25)

Jim answered "Not far from 80 Mc."

"Actually, said George, it's on 81.25 Mc. So this TV set, tuned to channel 2 would block out reception on a nearby receiver tuned to channel 6. Now try this channel 6 frequency and 107.5 Mc for F2 and F1 respectively.

Jim completed figure 2D. "Now the light begins to shine. If I change the frequency of the local oscillator the same amount as the change in channels, then F1 and F2 remain the same, no matter what the frequency of the channel in use."

"Right you are Jim" replied George. "Now what say we look at this subject of noise in the receiver, and how it affects DX reception."

(to be continued in April)

REQUEST FOR ALOCATIONS CHANGE

CP holder Charles J. Saunders of Flagstaff, Arizona has requested that the FCC change the present channels 9 and 13 allocated to Flagstaff to 4 and 9. Saunders indicated he would then ask that his channel 13 grant be moved to channel 4.

SITCO

Heavy Duty Quads and Yagis

Designed by SITCO for Translator off-the-air pickup, Community TV and extreme fringe area requirements.

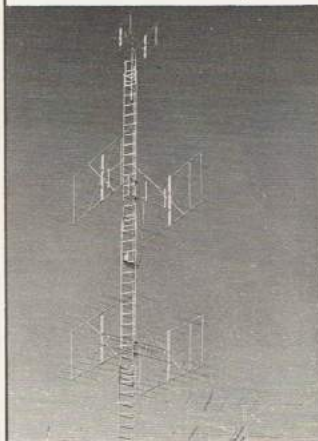

A Typical SITCO Installation

The SITCO Models 94 and 102 Quad Mount Antenna Arrays are designed to produce high gain, high front-to-back ratio and large aperture to weak signals. A completely balanced system which reduces noise pick-up and greatly improves the signal-to-noise ratio.

NOW, all SITCO element ends are machined to reduce static leakage. The signal-to-noise ratio is increased at sites where signal levels are low.

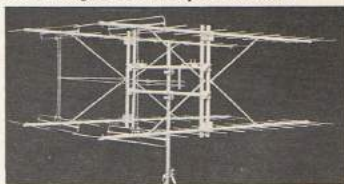

Model No. 102-HD 48-element Quad



Model No. 94-HD 32-element Quad

SIMPLICITY TOOL COMPANY

2850 NORTH MISSISSIPPI • PORTLAND 12, OREGON



THE WORLD

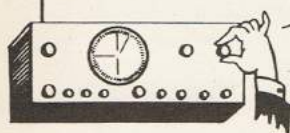

OF DX

SHORTWAVE EDITOR in Charge . KENNETH R. BOORD, 948 Stewartstown Rd., Morgantown, West Virginia, U.S.A.

CONTRIBUTING EDITORS A. R. "AL" NIBLACK, 420 Shelby Street, Vincennes, Indiana, U.S.A.

STANLEY LEINWOLL, Radio Free Europe, New York, New York, U.S.A.

MEDIUM WAVE EDITOR GLEN KIPPEL, 905 So. 2nd Avenue, No. 3, Sterling, Colorado, U.S.A.

BIG CHANGES IN STORE

Our earliest shortwave-medium wave readers will recall issues of **DXing Horizons** in the spring and summer of 1960 which included up to 20 pages of **DXing** news. Many have wondered why, in past months, it has been cut back to as few as 10.

As I outlined from this desk last month, the shortage of adequate manpower is for the most part to blame.

And the fact that the television industry is enjoying a phenomenal period of growth (as evidenced by our increased TV advertising) also has played a part in the "shrinking epic" of the **DXing** portions in **DXH**.

In the past thirty days much ground work underway for the past four months has come to a head. As a result of all of these factors the following changes will take place with the May issue of **DXing Horizons**.

DXing Horizons will be quietly retired to a well-earned spot on our office wall and will in effect become "Television Horizons."

All non-television material will come out of **DXing Horizons** (including shortwave and medium wave **DX** news and departments) and go into our second (new) publication "**COMMUNICATION HORIZONS**." **COMMUNICATION HORIZONS** will have ample growing room to accommodate the tremendous growth expected in the shortwave and medium wave departments in the years ahead. In fact, if your present plans do not change materially "**COMMUNICATION HORIZONS**" **DXing** news will average one and one-half to two times the space now allotted to it in **DXing Horizons**. This means more detailed shortwave news, a full three pages for medium wave news, and a return of the informative special features which our readers tell us they enjoy so much.

Communication Horizons will also include a substantial section for "International Shortwave Broadcasters" and a section devoted to the industrial radio service operating in the 150-160 and 450-470 megacycle bands.

In short, **COMMUNICATION HORIZONS** will report on the communications field.

We will have more details in April, but in the meantime, please check over the special insert between pages 2 and 3. It details your subscription "change over" procedure.

Horizons Publications
R.B.C.—Publisher

WORLD WIDE DX LEAGUE

... Certificates Issued

The following members of the **World Wide DX League** have submitted applications for awards as detailed in the September and October issues of **DXing Horizons**. While the certificates are not yet ready for mailing, these awards have been granted.

Medium Wave

WWAS—"all states (50) logged and verified"

- 1—Norman L. Maguire, Albuquerque, N.M.
- 2—Roy H. Millar, Bellevue, Wash.
- 3—Marvin E. Robbins, Omaha, Nebraska

HCC-MW-25—"25 countries logged and verified on medium wave"

- 1—Norman L. Maguire, Albuquerque, N.M.
- 2—Roy H. Millar, Bellevue, Wash.
- 3—Gunter Jacob, Passau, Germany

HDC-MW—"500 U.S.A. counties logged and verified on medium wave"

- 1—Norman L. Maguire, Albuquerque, N.M.
- 2—Marvin E. Robbins, Omaha, Nebraska

Shortwave

WWAS-Amateur—"logged and verified 50 states Amateur"

- 1—Gerry L. Dexter, Independence, Iowa

HCC-SWBC—"logged and verified 100 countries on shortwave broadcast"

- 1—Gerry L. Dexter, Independence, Iowa

SHORTWAVE STATION REPORT

DXing Horizons Salutes . . .

RADIO BUDAPEST, HUNGARY

Radio Budapest was "born" on December 1, 1925, when a PKI 2-kw medium wave transmitter was put into use on Csepel Island.

However, according to Anna Darvas of the North American Service of Radio Budapest, quite a bit of experimental work had been going on previously.

"There was a serious tradition of transmitting music and news in Hungary. It was the first country in the world to make use of the Telephonograph, operating as early as 1894. Inventor of the Telephonograph was Tivadar Puskas, who collaborated with Thomas Alva Edison. As its name indicates, the Telephonograph transmitted news to subscribers on a local line, and transmitted musical programs from the fourth floor of a building at No. 22, Rakoczi Street, Budapest. This location was later to become the studios of Radio Budapest.

"Wireless programs began in 1923, when engineers and workers of the Hungarian Experimental Post Institute began the first radiotelephonic experiments.

"In 1924, those working at the Experimental Institute tried to receive transmissions from abroad with a one-tube regenerative set."

Radio Budapest had 15,000 subscribers when it started—mostly radio "amateurs" who built their own receivers with parts procured at home. In a year, the number of listeners had grown to 50,000.

A new Telefunken 3-kw transmitter was equipped on Csepel in 1927 and the daily program time was expanded from 4 to 10 hours. The same year construction of a 20-kw transmitting station was begun at Lakihegy, also on Csepel Island, considered the best spot from which to cover the entire country by radio. This transmitter also was a Telefunken, which began operations on April 7, 1928. The antenna was built on two 150-meter-high high steel towers.

A new 120-kw station was put into operation in December 1933 at Lakihegy, with all equipment manufactured by the Hungarian Standard Electricity factory. The new antenna tower at that time "was the highest steel-constructed building on earth—reaching a height of 314 meters." It is interesting to note that the 480-ton weight of the tower, in the case of a disadvantageous direction of the wind, was supported by only a 9-cm-thick china wall "isolater!"

The shortwave station at Szekesfehervar began broadcasting in the '30s and radiated Overseas Programs.

World War II resulted in the demolition of the entire equipment of the Hungarian Radio. The withdrawing Nazi troops not only blew up installations but, in most cases, dismantled the equipment and so the country was without any radio station at the end of the war.

Radio Budapest was first heard again on May 1, 1945; the capacity of its antenna was only 100



A broadcast from one of the studios of Radio Budapest, Hungary. The violinist is Peter Dome, a member of the Hungarian Radio Symphony Orchestra.

watts which was just enough to power the loudspeakers situated on the streets and squares of the capital city. But the reconstruction went on with vigor, and by September 1945, the "voice" of Radio Budapest was again audible over radio receivers, too.

The 314-meter-high antenna tower was rebuilt. Budapest II was reconstructed at a new location in Szolnok, again with 135-kw capacity in August 1949.

After World War II, shortwave broadcasting started from Diosd in 1949, with stations of 40 kw which were heard well abroad, as reports from the U.S.A., New Zealand, and elsewhere testified.

"Our 135-kw shortwave transmitters which are working at present began operations in the 25, 30.5, 41.5, and 48.4 meter bands in seven languages — ENGLISH, French, Spanish, German, Greek, Italian, and Turkish. We transmit our special shortwave programs to Europe, North and South America. A FM program in the VHF band has now been put in working order, and the TV broadcasts are to be relayed on a new 30-kw transmitter."

"Our object is to get into contact with friends from abroad as much as possible—and with hams and SWLs," Miss Darvas comments. "The results of Hungarian broadcasting are the results of the devoted work of a little nation which is doing everything to become worthy of one of the peaceful achievements of humanity . . . of one of the greatest achievements of human knowledge and technique . . . the Radio!"—KEN BOORD

DXing HORIZONS SHORTWAVE NEWSCAST . . . OVER WRUL

Shortwave DX fans are reminded that the shortwave department of DXH produces a monthly "mid-term" DX newscast which is NOW broadcast over International Radio station WRUL (studios in New York City) at 1945 GMT and 2315 GMT on the third Saturday of the month (March 18).

WRUL is currently broadcasting on various frequencies in the 25, 19 and 16 meter bands.

MEDIUM WAVE

Edited by DXing Horizons
Medium Wave Editor
Glen Kippel

DXing HORIZONS

Medium Wave Log Book

All times are in 24 hour EST. Please make your reports conform to the following examples.

AMERICA

- 584 SPAIN—RNE, Madrid, need 2-2 at 1900 w-clock signal and Spanish ID, fair. (Cox, Dela.)
- 600 SURINAM—"R. Paramaribo" hrd here some eves, moved from 800? (Lob, N.J.)
- 620 ARGENTINA—IS5, Buenos Aires, good arnd 2200 w-frequent ID "R. Rivada-via—al Servicio de la Verdad!" (Tavares, Brazil)
- 644 BARBUDA — "Barbuda B/C Svc." hrd 1-29 from 1830-2235, had BBC nx 2100. (Cox, Dela.)
- 650 Venezuela—YVQO, Puerto la Cruz, hrd w-nx 0050. ID: "Ondas Portenas—la Emisora que Impera en el Oriente." QSL rcvd. (Tavares, Brazil)
- 660 Venezuela—"R. Caracas" hrd s-on 0530 as follows: "Desde Radiocentro en Caracas, Venezuela, funda del Libertador, transmite Radio Caracs" not R. Girardot as listed. (Hauser, Okla.)
- 665 PORTUGAL—CSA2, Lisbon, hrd 0100-0230 on 1-15. (Roys, Indiana)
- 700 Ecuador—HCJB, Pifo, in 0537-0545 on 1-16. (Hauser, Okla.)
- 700 Jamaica—Jamaica B/C Corp., Montego Bay, probably the mystery listed by Cooper, Calif. at 0505. (Hauser, Okla.)
- 720 CHINA—R. Peking weak at 0600 w-time pips on 1-17. (Millar, Wash.)
- 720 GUATEMALA — TGN, "R. Cultural" hrd 1957-2045, vy strong. Believe this is first reception in U.S. (Hauser, Okla.)
- 818 EGYPT (U.A.R.)—Cairo V, Batra, ntd 2-2 at 1900 w-Arab chanting, fair at times. (Cox, Dela.)
- 840 CHINA—Nanchang fair 1000, 1-18. (Millar, Wash.)
- 845 ITALY—Roma II, strg 1-15 at 2100-2102 w-Italian nx, 2102-2105 in ENGLISH. (Cox, Dela.)
- 880 New Zealand—1YC, Auckland seems to be best Zedder Mon. AM's. (Roys, Ind.)
- 880 Venezuela—YVKU, "R. Libertador," Caracas, in exc. 0535-0600, 1-30. (Hauser, Okla.)
- 1005 Costa Rica—TICCN "R. Cima," San Ramon, fair from 0558 for a few minutes. (Millar, Wash.)
- 1015 Panama—HOU44 hrd 0218 w-frequent ID "R. Reloj de la hora . . ." followed by correct time. (Tavares, Brazil)
- 1025 Costa Rica—TIAC "R. Fides" weak 0630, 1-24, stronger 0652, 1-28, but not pos. ID. (Millar, Wash.)
- 1045 GRENADA—Windward Is. B/C Svc., moved here from 1040. Hrd 1-17 2100-2200 w-cricket match, weak to good. (Cox, Dela.)
- 1142 U.S.S.R.—Kalingrad ntd 1-23 at 0100 w-Russian news, fair and vy clear. Faded out by 0200. (Cox, Dela.)
- 1180 Ryukyu Is.—VOA Okinawa strong 1-17 1000-1100. (Millar, Wash.)
- 1210 Venezuela—YVMN "R. Coro" poor on 1-23 at 0600. (Hauser, Okla.)

- 1322 PORTUGAL—R. Ribatejo hrd 0500, fair, QSL card, letter, photos rcd. QTH—Avenida 5 de Outubro 34 R/C, Santarem. Director is Yaimé Varela Santos. Sked: 0500-0900, 1200-1500, power is 150 watts. (Tavares, Brazil)
- 1385 GREECE—Athens II, hrd 1-16 at 0030 in native, faded by 0100. (Cox, Dela.)
- 1394 AZORES—CSB80, Angra do Heroismo, ntd 1-19, 1740-2000 s-off, fair but w-frequent fade-outs. (Cox, Dela.)
- 1420 Uruguay—CW43, Minas, QSA4 at 2150 w-ID "Transmite CW43, R. Lavalleja—1420 kcs en su dial—la Emisora de Su Preferencia" hi! (Tavares, Brazil)
- 1466 Monaco — 3AM2, Monte Carlo, excellent 0010, 1-16. (Cox, Dela.; Roys, Ind.)
- 1520 BRAZIL—R. Peju de Educacao Popular, hrd in Sweden, has only 100 watts. QSL by letter, address: R. Paju de Ed. Pop., c/o Mr. Waldecy Menexes, Afogados da Ingazeira, PE. (Tavares, Brazil)
- 1540 BAHAMA IS. — ZNS, Nassau, s-on 0600, copied w-extreme difficulty before KXEL s-on, 1-19. (Millar, Wash.)
- 1546 ENGLAND—BBC Third Programme weak 1-19 1730-1800. (Cox, Dela.)
- 1550 UNIDENTIFIED—GSTQ hrd 0559 on 1-16 followed by time in EST. Montserrat? (Hauser, Okla.)
- 1554 FRANCE—Nice I, in 1-15 0100-0230. (Roys, Indiana)
- 1594 UNIDENTIFIED—Perhaps AFRTS, Nouasseur, Morocco weak 1-19 at 1915. Another one here on 2-2 believed to be CSB4 in Lisbon, poor sig. (Cox, Dela.)

ATLANTIC

- 760 British Guiana—ZFY, R. Demerara, Georgetown hrd vy often lately arnd 2100 until c-d, S7-9. (Ericson, Sweden)
- 980 Algeria—Radio France 5, Algier, hrd nitely w-music, all in French, AN sked. (Ericson)
- 1095 SAUDI ARABIA—ARAMCO Radio hrd w-nonstop music 1-15 at 2100, poor sig. V/S Ray E. Davidson, Aramco, Box 1903, Daharan, Saudi Arabia. (Ericson)
- 1195 SAUDI ARABIA—AFRTS Daharan hrd 1900 w-nx, S5-8. (Ericson)
- 1200 BRAZIL—PRE9 Ceara Radio Clube, Fortaleza, hrd 1-29 at 2000, S7-9. (Ericson)
- 1349 UNIDENTIFIED—Arab talking hrd 2-1 at 2130 w-music, not Teheran 1340, which was hrd at the same time. (Ericson)
- 1367 FAROE IS. — Thorshavn has programs in Faroese arnd 0730, S7. (Ericson)
- 1500 ERITREA—KANU Radio, Asmara AFRTS, hrd w-DJ show at 2025, S4. (Ericson)

SPLATTER

- DOMINICAN REPUBLIC—R. Caribe stations HIU-860 and HIUA-1270 are 5 kw; HIUE-1310 is 2 kw; HIUC-1340, HIUD-1400 are 1 kw. (Jaar, Haiti)

ENGLISH LANGUAGE SW HORIZONS

"A monthly review of 'casts heard in North America in the English Language"

By
A. R. "Al" Niblack

MONTHLY LISTENING TIPS

The following listing consists of stations heard throughout North America during ENGLISH language broadcasts.

(Times to tune are in 24 hour GMT, frequencies in megacycles. EST subtract 5 hours, CST subtract 6 hours, PST subtract 8 hours. E indicates for LISTENERS IN THE EAST COAST NORTH AMERICA AREA; C, IN THE CENTRAL U.S.A. AREA; and, W, IN THE WEST COAST NORTH AMERICA AREA.

- 0000-0100
JAPAN (Tokyo, 0300, N-E) 17.855, 15.135, W (Balbi, Calif.)
- 0100-0200
TAIWAN (Taipei, 0130) 17.785, 15.235, W (Balbi)
- 0200-0300
CANADA (Halifax, 0200, N-E) 6.130, E
CHINA (Peking, 0210) 9.480, C
HAITI (4VHW, 0215, Fridays ONLY) 6.200A, C
INDIA (New Delhi, 0230-0245, N-E) 11.710, W (Balbi)
- 0300-0400
POLAND (Warsaw, 0300) 15.275, E
ROUMANIA (Bucharest, 0300) 5.980, C
- 0400-0500
KENYA (Langata, 0400, BBC N-E) 4.934, E (Cox, Dela.)
MOZAMBIQUE (L. Marques, 0430A) 9.617, E (Cox)
RHODES (VOA Relay, 0400, ENGLISH ID) 6.040, C
- 0500-0600
JAPAN (Tokyo, 0500, N-E) 15.235, 11.800, W (Balbi)
KOREA (SO.) (Seoul, 0530, N-E) 9.640, 11.930, W (Balbi)
NIGERIA (Lagos, 0500) 4.990, E
- 0600-0700
SIERRA LEONE (Freetown, 0640) 3.316, E
NEW GUINEA (AUSTR.) (Port Moresby, 0600-0645) 9.520 (NEW), W (Balbi)
NEW ZEALAND (Wellington, 0630) 9.540, C
- 0700-0800
USSR (Moscow, 0700, N-E) 11.850, 9.540, 9.735, W (Balbi)
- 0900-1000
AUSTRALIA (Melbourne, 0900, N-E) 7.190, W (Balbi)
SINGAPORE (BBCFES, 0910) 11.955, W (Balbi)
- 1000-1100
TAIWAN (Taipei, 1005-1050) 11.920, 6.095, W (Balbi)
THAILAND (Bangkok, 1030 N-E) 11.910, 7.300, W (Balbi)



Jozsef Kun, a trained technician and journalist, and assistant editor-in-chief of the periodical, *Radio-technika*, is editor of the Tuesday feature, "Calling Radio Amateurs," from Radio Budapest, Hungary.

- 1100-1200
INDONESIA (Djakarta, 1130, "Mailbag" every third Sunday) 9.585, 11.795, W (Balbi)
- 1200-1300
BORNEO (NO.) (Jesselton, 1230) 4.970 (NEW), W (Balbi)
- 1400-1500
KOREA (SO.) Seoul, (1430, N-E) 9.640, W (Balbi)
PAKISTAN (Karachi, 1430) 15.155, E
- 1500-1600
BURMA (Rangoon, 1500-1515, N-E RETIMED) 6.015, W (Balbi)
JAPAN (Tokyo, 1525, N-E) 9.525, 11.800, W (Balbi)
INDIA (New Delhi, 1530-1545, N-E) 9.620 (NEW), 9.705, W (Balbi)
- 1600-1700
SINGAPORE BBCFES, 1600, N-E) 9.690, W (Balbi)
- 1800-1900
GERMANY (FED.) (Cologne, 1800-1805, N-E) 15.405, C
- 1900-2000
LIBERIA (Monrovia, 1920, N-E) 15.085, C
- 2000-2100
AUSTRALIA (Melbourne, 2000, N-E) 15.315, W (Balbi)
ISRAEL (Tel-Aviv, 2015, N-E) 11.918, E (Cox)
- 2100-2200
WINDWARD IS. (St. Georges, 2145) 15.395A, C
PHILIPPINES (FEBC, 2130 ENGLISH ID) 17.805, E
- 2200-2300
GHANA (Accra, 2230) 11.790A (NEW), C
HUNGARY (Budapest, 2200-2230A) 6.235, 7.220, E (Cox)
EGYPT (UAR) (Cairo, 2200) 11.915, E
- 2300-2400
HAITI 4VWI, 21.520, E (Cox)
Propagation forecasts indicate that the major portion of your nighttime DXing should be spent in the lower frequencies—possibly 31, 41, 49, 60, and 90 meter bands. The static level for the latter three bands mentioned is still at a minimum and will remain reasonably so for a period yet to come.
With this issue you will note that the style of the listings has been altered. The new time slot method may be of greater value and facilitate your efforts. Plan to be with us next month when your editor will continue to report English Language 'Casts.—A.R.N.

AT FADE-OUT

(The following pages of DX News represent the combined listening and reporting efforts of DXing Horizons SW readers in 73 countries, detailing the very latest available SW DX news. All times are in GMT.)

The world-renowned DXer, Arthur T. Cushen, is now compiling and voicing (via tape recording) the DX news portion of "THIS RADIO AGE," the monthly DX session heard over R. New Zealand, Wellington, on the FIRST WED. of each month at 0810 and 1030 GMT on 9.540, 6.080. Features on "THIS RADIO AGE" continue to be handled by Cleve Costello. Comments and suggestions are desired by Art, whose QRA is 212 Earn Street, Invercargill, New Zealand. Incidentally, Art's SW veries at the end of 1960 stood at 2,430.

Now to this month's reports (GMT):

AFGHANISTAN—R. Kabul, 9.705, still strg in Britain but w-bad QRM 1830 Fr., 1900 ENG. (Pearce)

ALBANIA—R. Tirana, 7.157, hrd w-ENG. 2230-2258. (Pearce, England)

ANGOLA—CR6RD, 4.851, Nova Lisboa, fair just prior to 2130 s-off w-recorded mx to 2125, then 3-min summary of N-Pt. CR6RY, 4.838, Nova Redondo, closes 2200 w-"A.Pt." 4-gong IS. (Kary, Va.) Generally weak-fair in Dela. but w-slight QRM frm Mozambique, 4.840, at times; prgms noted were almost entirely instrumental mx. (Cox) R. Clube de Benguela, 9.502, is again observed to 2130 s-off after "A. Pt."; IS is 2 gongs. (Berg, Conn.) CR6RZ, 17.795, Luanda, tuned 2118 w-gud recordings; 2120 ID and more mx; 2215 ID and N-Pt.; recordings to c-d-2229. (Ferguson, N.C.; Rowell, Minn.; Buchanan, Mo.)

ARGENTINA — R. Splendid, 11.880, Buenos Aires, S9 arnd 0330 some nights (when XEHH, Mexico, seems "silent"); usual format in Sp. (Niblack, Ind.) LRA32, 9.690, noted 0300-0500 w-mx, ENG. and Sp. (Rowell, Minn.)

AUSTRALIA — Due to Brt. Summer Time (March 26-Oct. 29 this yr), from March 26 onwards, R. Australia's beam to the UK and Eur. will be RETIMED to 0600-0730, 11.710. (RADX) R. Australia hrd on 11.840 at 2100-2200 w-N-E, mx. VLW6, 6.140, Perth, noted 1430-1500 w-N-E, mx. (Rowell, Minn.)

AUSTRIA—OEI21, 6.155, Vienna, noted 0600-0815; ID for "Shortwave Service of the Austrian Radio" in ENG., Ger., Fr.; N-Ger. 0700. (Balbi, Calif., others) Hrd ID 0730 w-ENG. ANNCMT of "This is Austria calling with a test transmission 0500-0900 and 1900-2100 GMT daily." (Kary, Va.)

BARBADOS—The Barbados Rediffusion Service, Ltd., was to radiate commentaries on the Barbados Turf Club Meeting over Messrs. Cable & Wireless, Ltd., Bridgetown, Feb. 23, 25, March 4, 11 at 1700-2130 on EITHER ZNX32, 7.547, OR ZNX20, 5.040. (Kander, Ohio, via RADX, SCDXERS)

BELGIUM—ORU, 9.765, noted 0010-0030 in Minn.; hrd parallel over 17.845, 17.860 at 1600-1700. (Rowell)

CANARY IS.—La Voz de la Isle de la Palma, 7.345, hrd s-on 1945 w-march, then Sp. ID by woman, strg sig in Dela. (Cox) Hrd 2030-2100 w-pop mx, then N-Sp. frm RNE. (Newhart, N.J., AMSWLC)

CEYLON—Commercial Serv., R. Ceylon, 15.265, Colombo, gud frm 0130 s-on to 0330; BBC nx relay in ENG. 0200. (RADX)

CHILE — CE1174, R. Nuevo Mundo, 11.740, Santiago, hrd 0200-0230 w-nx, commentaries in Sp. (Newhart, N.J., AMSWLC)

CHINA—R. Peking, 12.060A, noted 1715-1830 in ENG., parallel 9.775; strg in Calif. (Balbi)

COLOMBIA—R. Continental is now on 6.125, REPLACING 4.835, hrd occasionally arnd 0500 s-off w-severe QRM frm R. Suyapa, Honduras. (Newhart, N.J., AMSWLC) Noted in N.Z. on 6.125 to AFTER 0700. R. Santa Fe, 4.965, now seems to be on 24 hrs a day. (Cushen) Noted fair in Calif. 0516. (Neves) HJGF, 4.845M, Bacaramanga, tuned 0330 w-ID in ENG., mx, then ANNCd in ENG.: "From people to people in the form of Colombian music"; 0345 asked for rpt; hrd s-off 0359. (Ferguson, N.C.)

CONGO REP.—R. Brazzaville, 15.190, features N-Fr. 2030-2050A w-"Nouvelle Afrique" 2035. (Kary, Va.) Now noted on 9.545 at 2315; hrd on 9.770 at 2100 w-semi-classical mx, Fr. (Niblack, Ind.)

CONGO (THE)—Noted w-N-E to Eur. 2145; hrd on EXTENDED sked to N. Am. to 0235A s-off; N-E 0145; strg; ID as "Leopoldville, Congo Network." (Balbi, Calif.; Rowell, Minn.; Berg, Conn., others) Leopoldville, 9.700, audible EARLY as 0430 w-listeners' requests and other mx to 0530A; after ID as "Ici Leopoldville, Radio-diffusion Nationale de Republique du Congo" and IS, N. Fr., beginning w-"nouvelle de Republique," ensues to 0550 when mx resumes. (Kary, Va.)

CUBA—Havana on 11.762A seems on IRREG sked; noted arnd 0215-0230 in Sp., w-some Fr. being used; lots of propaganda. Cuban logged on 6.135A at 0140-0200 s-off w-similar format; stn on 12.060M hrd 2350 ANNCG "This is a Radio Station of the Radio Corporation of Cuba, Havana," with TEST. (Niblack, Ind.) The 11.762A one is noted in Okla. "nightly" w-N-Sp., economic mx, mx; man and woman anncrs; IDs as "Radio Habana, Cuba," and "La Voz Libre de America"; comes on w-tuning and ID sig, hrd 0100-0200. (Stephenson)

CZECHOSLOVAKIA — R. Prague, 5.935, hrd 0500 w-ENG. ID, strg but w-CWQRM. (Cox, Dela.) Noted on 7.340 after time pips 0430 in Sp.; gud in Fla. (Alcock)

DAHOMY—Cotonou, 4.870, spot-checked several times w-N-Fr. 0600, 0615; strg multiplex and radioteletype QRM badly impair readability in Va. (Kary)

DOMINICAN REP.—R. Caribe, Ciudad Trujillo, in the 19-mb. lately has been DOWN to 15.050M. (Niblack, Ind., others) Hrd on NEW fq, HI5U, 3.322, regularly 2200-0600 s-off, parallel 6.210, 9.485, 15.050. (Newhart, N.J., AMSWLC) By now, some ENG. sessions should have been initiated for listeners in U.S.A., Scandinavia, Afr., elsewhere, on the 9.485, 15.050 fqs ONLY. (Jaar, D.R.)

ECUADOR—An Ecuador stn is noted on 6.065A arnd 0300 to 0400 s-off; POSSIBLY is at Cuenca

and may be "La Voz de la Popular." (Niblack, Ind.) A NEW stn recently hrd on 9.620A w-slogan of "Radio Atlantida" and location was given as Quito. (Washington, N.Y.)

EGYPT (UAR)—R. Cairo, 7.050, 11.745, noted 0630-0700 w-dictation-speed N-E, excellent in N.H. (Bowker) Observed w-ENG. 1330-1400 for India on 17.915A; has ENG. for Eur. 2130-2230 on 11.915A. (Pearce, England)

ETHIOPIA—R. Addis Ababa is again being hrd on 11.955 at 1815 ENG., 1830 Fr. to s-off 1845 to W. Eur.; 17.775 ANNCD to W. Afr. NOT HRD in Minn (Rowell)

FIJI IS.—Suva, 5.980, noted w-native-type prgm 0730-0745, then w-ID in ENG.; heavy QRM soon "buried" stn. (Saylor, Va.)

FINLAND—OIX4, 15.190, Helsinki, tuned on a MON. 1558 w-IS, s-on 1600 w-ID in ENG., lang, then prgm "Something For Everybody"; at 1605 man w-"Finnish Diary" to 1609 ID, when introduced mx prgm. (Ferguson, N.C.)

FRANCE—RDTF, 9.585, Paris, gud when c-d 2200 in Ar.; hrd on 15.160 at nice level when c-d in Fr. 1745. (Niblack, Ind.)

GABON—Libreville, 7.270, Noted 0500-0630; N-Fr. 0500, 0600; s-off 0630 w-Anth. and ID; strg sig. (Balbi, Calif.) This new 7.270 outlet is noted in N.Y. w-powerful sig when opening 0500, w-ID of "Ici Libreville, Radiodiffusion Gabonaise." (Washington) Hrd on 4.777 w-ID "Ici Radio Gabon, emissions Libreville," w-fair sig but suffers frn strg RTT, CW, and voice splatter (from YVLA, Valencia, Venezuela) arnd 2100 when N-Fr. is already in progress, concluding 2105; closes 2300 after IS, march. (Kary, Va.)

GERMANY (EAST)—R. Berlin International, 11.765, noted w-ENG. to Middle East 1600-1630; 1800-1830 on 7.300, 6.115 (says also 9.730); at 2000-2030 is BEST on 6.115, but also noted on 7.300, 9.730; same channels noted 2200-2230. (Pearce, England)

GERMANY (WEST)—Munich, 6.085, 10 kw., has dly N-ENG., Ger., Fr. 0800-0810. (Uthoff, Germany, via RADX) on March 5, DW, Cologne, will effect these changes — to Japan 0945-1245, 1545, 21.730, 17.875; to Africa 1715-2015, 15.275, 11.895. (Newhart, N.J., AMSWLC)

GHANA—Accra, 15.190, was readable ONLY ONCE altho many checks were made; logged 1530 to PROBABLE s-off 1600A; following religious service in vernacular 1545-1559, closing annmets in vernacular, ENG. were given w-ID for "National Service (?) of the Ghana Broadcasting System." By 1600, QRM frn Finland's OIX4 was so intense that Accra's sig could no longer be distinguished; OIX4's carrier comes up 1545. (Kary, Va.) Accra has been hrd on 11.798A (ANNCG 11.795) arnd 1900-2300 s-off, mostly ENG., some Fr., w-TEST b-c: at times is badly "squeezed" by Cologne, 11.795, and Hilversum, 11.800. (Niblack, Ind.; Saylor, Va.; Rowell, Minn.; Washington, N.Y.; KBLP, others) Has N-E 2000. (Saylor, Va.) Noted on 3.366 w-N-E 0600. (Newhart, N.J., AMSWLC)

HAITI — 4VB, R. Commerce, 5.985, Port-au-Prince, noted s-on in Fr. 2030. (Saylor, Va.) A note on QSL frn R. Haiti says it discontinued ENG. b-c in Dec. (Newhart, N.J., AMSWLC) 4VEH, 6.121A, Cap Haitien, tuned 2200 when opened w-prgm items; N-E 2345-2300, then cont'd

w-recordings. 4VWI, 9.773, tuned 0300 w-ID, fqs, and "Bulletin Board" session; ANNCD as on 1,035 kc., 6.121, 9.773, 21.520. Was tuned on 21.520 at 1830 w-religious b-c in Sp.; 1838 N-Sp., ID was given several times; 1900 ID and Fr.; also hrd 2130-2200 in ENG., w-ID and fqs; gave sked as 0945-1400 or 1430 to Eur.; 1700-1900 South; 2245-0430 West. (Ferguson, N.C.) Several other monitors rpt the NEW 21.520 hrd at various hrs. Acgdg to an invitation rcd from the Oriental Missionary Society. "The Evangelistic Voice, Radio Station 4VEH" was OFFICIALLY DEDICATED Feb. 23. (KBLP)

HAUTE VOLTA—Ouagadougou's 0615-0705A xmsn on 4.815 has surprisingly gud level despite intense het frn powerful unmodulated carrier on 4.820; N-Fr., ANCD as "Journal Parle," is aired 0630-0645A; frequent ID is "Ici Ouagadougou, Radiodiffusion de la Haute-Volta." (Kary, Va.)

HOLLAND—Hilversum is rptd using SEVERAL NEW fqs. (KBLP) "HAPPY STN PRGM" by Eddie Startz noted SUN. 1600-1729 over the 21.480 outlet. (Ferguson, N.C.)

HONDURAS (BRT.)—R. Belize, 3.300, noted 1200-1300 w-"morning mx" and "Just Music" prgms; excellent level, frequent time checks; all-ENG. (Santos, Calif.) Hrd 0145 w-hit record show. (Ferguson, N.C.)

INDIA—AIR, 7.225, noted 1445 s-on to 1515 in native, strg at s-on. (Balbi, Calif.) Delhi hrd w-N-E 1330 in beam to SE Asia on 17.705, 21.565A. (KBLP) Hrd on 11.780 opening 1230 in ENG., then goes into native prgm. (Niblack, Ind.) Found on 11.895 at 0030-0045 w-N-E; noted on 9.705 at 1600-1645; Bombay, 9.550, hrd 1430-1530 in native prgm. (Rowell, Minn.)

INDONESIA—NEW RRI outlet, 4.770, location UNKNOWN, observed 1400-1530 w-Wn. mx and native lang. (Balbi, Calif.) "Voice of Indonesia," 11.792, Djakarta, noted starting N-E 1115. (Kary, Va.) YDF6, 9.586M, Djakarta, now on this fq 1900-2000 to Eur. in ENG.; noted w-N-E by man 1915, ID 1921; fair to gud w-QSB; parallel 11.710. (Cox, Dela.)

IRAN—R. Teheran noted on 7.045 at 2045 w-ENG. but STILL ANNCG 7.285 fq. (Cushen, R. N.Z.)

IRAQ—R. Baghdad, 6.030, hrd via "long path" 1422 to PAST 1430 in lang w-native instrumentals; QRM on fq. Weak 2105-2115 on 3.297M w-Ar. nx by man; s-off arnd 2117. (Cox, Dela.) The 6.030 outlet noted w-Ger. 2000, ENG. 2030. (Pearce, England)

ISRAEL—LATEST CORRECT fq for Tel-Aviv's 25-mb. outlet is 11.918M, noted w-IS 2015, then ENG. ID and N-E by man. (Cox, Dela.) Parallels 9.009. (KBLP)

ITALY—R. Rome has NATO N-ENG., Fr. on THURS. 1755-1810, 9.710, 7.275, 5.960. (Uthoff, Germany, via RADX)

IVORY COAST—R. Abidjan, 4.940, hrd 2230 to s-off 2358; veried via airmail in 15 days! (Ferguson, N.C.; Rowell, Minn.)

JAPAN—FEN, 6.160, Tokyo, fair, clear 1300 w-N-E by man. (Cox, Dela.) NHK, 11.800, Tokyo, observed 0030 in ENG., fair. (Niblack, Ind.)

JORDAN — Amman, recently MISSING frn 7.155, was found on 9.530 arnd 0630. (Kary, Va.)

KATANGA—R. Katanga, 11.866, Elisabethville, vy strg in the Dominican Rep. 1900 to arnd 2200; Fr., ENG. noted. (Jaar) Hrd w-N-E 2015 by woman. (Pearce, England; Rowell, Minn.) Gud in Ontario frm arnd 0400. (White)

KENYA—ZGW, 4.934, Langata, noted 0400 w-BBC nx; fair but w-CWQRM. (Cox, Dela.) Accd to word direct frm a stn official, the Kenya Broadcasting Service's NEW Broadcasting House is "now open for business," and all major network prgms originate frm this bldg, located in the center of Nairobi. The NEW Coast Regional Stn at Mombasa is now in operation on 791 kc., MEDIUMWAVE; consists of 2 separate 10-kw. xmtrs. The NEW Receiving and Monitoring Stn was occupied in late Feb. (KBLP)

KOREA (SO.)—HLKS, 9.641M. Seoul, noted 2235 w-Fr. lang, QRM'd via stn on 9.640; weak level in Dela.; also noted gud level 1440 w-Korean mx, man in ENG. (Cox)

KUWAIT—R. Kuwait, 4.967A, noted 2050-2109 c-d w-Ar. mx, nx. (DSWC)

LEBANON—R. Beirut, 8.004M, noted on this "old" spot 2053 w-Ar. instrumentals and lang; heavy CWQRM. (Cox, Dela.)

LIBERIA—TEST xmsn to Near East, MON-SAT. 1845 (SUN. 1815)-1940 hrd well in northern Argentina on ELWA, 15.085, Monrovia; 1920-1940 s-off native talk, followed by top African N-E. (Roeske) Hrd on 11.825A w-fair sig 1925 w-religious prgm; the 15.085 outlet has Afr. N-E 1920A, gud level in Indiana. (Niblack) Noted on 15.085 w-TEST 1900, and hrd w-second sked to s-off 2230; 2015 Fr., 2100 Ar., 2200 Pt.; anncd TEST and asked for rpts. Ferguson, N.C.)

MALI REP.—Recently, R. Mali, Bamako, was hrd TESTING on 0.707A arnd 0700-0800 c-d; vy few anncmts and poor modulation; SINPO 32422. (Washington, N.Y.)

MARTINIQUE—Fort-de-France, 3.315, opens w-IS and "La Marseillaise" 1015A followed by ID of "Ici Fort-de-France, Radiodiffusion Television Francaise." "Journal Parle" frm Paris is b-c 1030-1050 and local nx and/or ANNCMTS in Fr. 1050-1055A. (Kary, Va.)

MAURITANIA—R. Mauritanie, 4.855, St. Louis, hrd 0719 fair w-native mx; noted 2305-2345 w-non-stop native mx to 2334, then brief anncmt and more mx to abrupt s-off; fair level in Mo. (Buchanan)

MONACO—Transworld Radio noted w-TEST xmsns on 7.200 at 2100; 11.850 at 0500; 9.705 (ENG.) 0730-0830; asks for rpts to Box 141, Monte Carlo, Monaco, (Cushen, R. N.Z.) Noted TESTING 2030-2100 s-off w-ANNCMTS in ENG. on 6.120 (BUT MORE RECENTLY WAS DOWN TO 6.110); organ mx; asks for rpts. (Roth, Schwartz, Conn.)

MOROCCO—Rabat, VARYING 6.185 to 6.210, comes on air 0628 w-lengthy rundown in Ar. of xmtr locations, powers, fqs; Korean recitation 0632, summary of world nx in Ar. 0700-0705A; prgm in Berber 0730. Rabat, 15.337, hrd 1633 s-on w-bad hum and low audio level; sked 1630-1700 dly w-Fr. MON-WED-FRI., dialects TUE., Ar. THURS., SUN. Recent SUN. check found stn b-c just PRIOR to 1628 w-pause 1628-1633 before NEW xmsn began; both outlets ID in Ar. w-"Huna Rabat, isz'at al-Wataniyah al-Magribiyah." (Kary,

Va.) Hrd on 11.735 at 1800-1830 in ENG., Fr. 1830-2030, then Ar.; ENG. LESSON 1830. (Bowker, N.H.)

MOZAMBIQUE—CR7BG, Lourenco Marques, ANNCd 15.152 but ACTUALLY on 15.145A, noted w-QRM frm ZYK33, Brazil, 1639-1800. (RADX) CR7BM, 3.222, noted frm 2130 w-usual ENG. prgm, pop mx, fair when c-d 2200. CR7DE, 9.617M, noted DOWN to this reading 0435 w-usual ENG. prgm, parallel 11.759M, fair level, gud on latter channel. Hrd on 4.859M at 2030 w-ENG. religious prgm, s-off 2103; bad CWQRM. (Cox, Dela.)

NEW CALEDONIA—R. Noumea, 6.035A, hrd in Fr. nx 0800-0815, then mx; S5-8 and in clear in Conn. (Schwartz)

NIGER REP.—R. Niger, 4.785, Niamey, noted 0530 s-on w-native vocals; 0600 N-Fr. (Buchanan, Mo.; DSWC)

NIGERIA—Western Nigerian Radiovision Serv., Ibadan, 6.049A, noted 0500-0730; BBC nx relay 0700; badly QRM'd by HCJB, 6.050. (Balbi, Calif., others) Nigeria hrd on 7.285 at 0600-0730; ENG. to 0700, then native. (Balbi) Ibadan noted on 6.049M fair to gud 2000 w-N-E by man, QRM frm BBC on 6.050. (Cox, Dela.) Accd to word direct frm stn, by now the 3.380 ("night-time") outlet should be in operation, and the LISTED 6.050 outlet MOVED to 6.185; both are 10 kw.; rpts are wanted to Box 1460, Ibadan, Nigeria; QSL'd by cd, ltr. (Roth, Conn.)

NORWAY—LLD, 9.550, hrd 2100-2200 in Norwegian. (Rowell, Minn.)

OKINAWA—VOA Relay Base, Naha, hrd on 7.230, at times parallel 7.155, 1400-1630; N-E 1400, 1500, 1600. (Balbi, Calif.)

PAKISTAN—Dacca, 7.140, weak to fair 1238 w-native mx, woman in lang. Karachi, 15.145M, excellent 1535 w-N-E at dictation speed by man. (Cox, Dela.) Noted on 11.672A at 1900 ending b-c in ENG. that starts 1815 to Turkey; ANNCES 7.010 as parallel; nice sig. (Schwartz, Conn.)

PERU—OAX4T, 15.152.5, Lima, excellent 2330 w-Sp. ID by man. (Cox, Dela.; Hathaway, Texas)

PHILIPPINES—FEBC, Manila, now noted on DZ19, 7.250, hrd to 1700 s-off, when ANNCES complete FEBC stns as DZB2, 3.345; DZH6, 6.030; DZ19, 7.250; DZH7, 9.730; DZH8, 11.855; DZF2, 11.920; DZH9, 15.300; DZF3, 15.385; DZ16, 17.800; DZ18, 21.515. (Cushen, R. N.Z.) Hrd on 11.920 w-ENG. religious prgms 1430; N-E 1430, 1545; Russian 1630-1700; c-d 1705. (Bowker, N.H.)

PORTUGAL—EN, 15.380, Lisbon, noted 1715-1800, parallel 17.895, in ENG. to S. Afr., Goa. (Balbi, Calif.; KBLP)

RHODES—VOA Relay Base, 7.265, THE COURIER, hrd 0600-0630 s-off; N-E 0600; fair. (Balbi, Calif.) Hrd on 6.040 w-pop mx prior to actual s-on 0400 when gives ID in ENG., then goes into Ar. (Niblack, Ind.)

RHODESIA—FBC's Afr. Serv. noted on 9.570A (MOVED frm 9.575), Lusaka, w-N-E 0500; also hrd 1445-1545, but NO LONGER w-N-E 1530; ID 1545 s-off. (Balbi, Calif.) Observed in N.C. 0515 w-ANNCMTS in ENG. and a number of dedications, greetings to listeners; 0600 ID, BBC nx to 0610, when ID for 31 and 41 m.b. and s-off 0611. (Ferguson)

RUANDA-URUNDI — R. Usumbura, 6.195A, hrd at weak level 0500-0530 w-QRM frm Colombian to 0505A, then frm BBC; closed w-Belgian Nat. Anth. (Washington, N.Y.)

RUMANIA — LATEST sked frm R. Bucharest lists N. Am. sked as 0130-0230, 11.810, 9.510, 7.225, 7.195, 6.190, 5.980; 5.980; 0300-0330, 0430-0500, 11.810, 9.570, 9.510, 7.225, 7.195, 6.190, 5.980; a DX prgm is aired every SECOND and LAST FRI. of month in the THIRD xmsn. (Irwin, Tenn.) N-E noted on this channel 0430, followed by commentaries in ENG. (Rowell, Minn.)

SAO TOME—R. Clube de Sao Tome, 4.807M, hrd frm 2030 fade-in w-dance instrumentals, classical mx; CWQRM via 4.805; very few ANNCMTS until 2059 when woman gave ID in Pt., then s-off w-"A. Pt." On a SUN. remained on to 2130. (Cox, Dela.)

SAUDI ARABIA — Djeddah-Mecca, 11.950A, hrd 1812-1903 in Ar. (Rowell, Minn.)

SENEGAL—R. Senegal's 100-kw xmttr is now USED EXCLUSIVELY to Eur. 1730-1800 (may NOT be dly—Ed.) on 15.115, in Fr., Ger., ENG. The H. Serv. uses 25 kw. on 11.895, 7.210, 4.950. (Uthoff, Germany, via RADX) The 15.115 channel is overridden by HCJB, Quito, Ecuador; between 1730-1800 has frequent ANNCMTS in Fr., Ger., ENG., and a talk in each lang interspersed w-mx interludes; receptn rpts requested to R. Senegal, P. O. Box 1765, Dakar, Senegal. (Kary, Va.)

SIERRALEONE — Freetown, 3.316, noted w-ENG. mx prgm 2115. (Saylor, Va.)

SINGAPORE—R. Singapore, 7.250, noted 1400-1430, weak sig in lang; ID in ENG. at s-off 1430. (Balbi, Calif.)

SPAIN—RNE, 5.995, Madrid, hrd 0800 s-on to 0830 in Sp.; strg. (Balbi, Calif.) Hrd on 6.000 strg frm 1950 w-Sp. mx, N-Sp. 2000. (Cox, Dela.) Noted on 6.130 w-N-E 2020-2050; says also on 7.100. (Pearce, England)

SP. GUINEA—Bata, 7.846M, Rio Muni, hrd frm 2053 w-instrumentals and Sp. lang; s-off w-mx 2101; fair sig but w-QRM frm unmodulated carrier. (Cox, Dela.)

SURINAM—PZC, 4.849, Paramaribo, gud frm 2115 w-woman in Dutch. (Cox, Dela.)

SWEDEN—R. Sweden, 9.725, Stockholm, fine sig 0115 tuning. (Saylor, Va.)

SYRIA (UAR) — R. Damascus, 5.705M, found 2205 w-song and ID in Ar.; hrd to c-d 2300 w-march; another day hrd w-tone 0353; 0355 IS, and s-on 0400 w-ID, mx and singing followed. (Ferguson, N.C.)

TAIWAN (FORMOSA) — "Voice of Free China," Taipei, noted in N. Am. Serv. on BED56, 17.785 at 0130-0200; fqs ANNC were 17.785, 15.235, 7.255, 6.095. (Ferguson, N.C.)

TANGANYIKA — TBC, 5.050, Dar-es-Salaam, noted 0330-0502 in the clear, strg; N-E 0415. (Bowker, N.H.)

THAILAND—HSK, 4.830, Bangkok, weak 1248 w-Thai vocals and lang; HSK6, 7.300, fair arnd 1210 w-woman Thai. (Cox, Dela.)

TOGO—R. Lome, 5.045, has N-Fr. 0630-0645A; THURS., perhaps other days, too, ENG.-Fr. LESON is b-c 0615. (Kary, Va.)

TONGA—Tonga time is now 13 hrs AHEAD of GMT and "is first country in the world in time";

formerly, the Chatham Islands, w-local time 12 hrs 45 min was the furthest AHEAD of GMT. (Cushen, R. N.Z.)

TUNISIA—On a recent SUN. R. Tunis, 17.826, was logged 1515 to sudden c-d 1558 when xmttr was presumably returned to 11.790 channel. IDs w-"Iza'at al-Juhuriyah fi Tunisiyah." (Kary, Va.) Noted on 11.970 (RETURNED frm 11.925) at 1900 in Ar. (Berg, Conn.; Bowker, N.H.; Buchanan, Mo., others)

TURKEY—TAP, 9.747M, noted frm 2140 w-pop tunes, lang ID by man 2202 and s-off excellent sig in Dela. (Cox)

UNID — Unmodulated carrier on 11.930, ID WW2XAJ in Morse code on half-hr or each hr on the half-hr; seems to be propagational study xmttr, but is NOT operated by the Crosley Broadcasting System as was the case of W8XAL, 6.080, in former years. (Kary, Va.)

UNION OF S. AFR.—SABC, 17.855, hrd 1800-2000 c-d in spite of rpts that is no longer using this fq; 21.495 outlet hrd 1700-1800, fair sig in Calif. (Balbi) SABC, 4.810, Paradys, is occasionally audible 2100 when SABC N-E frm Johannesburg is aired. Kary, Va.)

UNITED SOMALI REP. — Hargeisa, 9.667.5, hrd 1440 w-Somali vocals, flute mx to 1500 fade-out; another day noted frm 1330 in native, chanting began 1331, fair sig in Dela. (Cox)

USSR — R. Moscow, 6.165, noted 1000-1500, mostly in lang but w-N-E 1030; parallels 7.185, 9.710, to SE Asia. H. Serv. 6.005 (NOT LISTED), parallel 6.115, 7.210, noted arnd 0800-1500. (Balbi, Calif.) Petropavlovsk, 5.050, hrd frm 0815 fade-in w-woman in native. Novosibirsk, 4.430M, weak 1225 w-Russian mx and lang, man and woman anncrs. Khabarovsk, 9.790, weak level 1930 w-Russian nx-or talks. Cox, Dela.) Khabarovsk 9.750, noted 2100 in Russian mx. R. Magadan, 4.996, hrd 0445-0500 in Russian session. R. Moscow has been hrd on 9.610 at 1915 in ENG. anncg as "Pacific Coast Service." (Rowell, Minn.) Roth, Conn., has just rcd word frm R. Erevan, Armenian SSR, that it now has ENG. b-c to N. Am. 0100-0130 FRI. ONLY on 15.115, 11.895, 11.735; wants rpts.

VATICAN—HVJ, 11.740, hrd 0030-0045 in Sp. (Bowker, N.H.) Noted opening 1000 on 21.515 in Pt. prgm. (Pearce, England)

VENEZUELA—R. Cultura, 5.050, noted 0000-0300 in Sp., mx. (Rowell, Minn.)

VIETNAM (SO.) — R. Saigon, 11.950, noted 1400-1500 in native mx, nx in native 1445. (Rowell, Minn.)

WINDWARD IS.—WIBS, 5.010, St. George's, Grenada, noted 2135 w-request mx prgm. (Saylor, Va.)

YUGOSLAVIA—R. Belgrade hrd in ENG. 1530-1600 on 15.240, 11.715, 9.500A; THUR. has listeners' ltrs, requests; also hrd 1645-1700 on 15.240, 9.500A, 7.200. (Cushen, R. N.Z.)

DEADLINE—Due to space limitations, please send ONLY your TOP-NOTCH items TO REACH ME BY THE 13TH OF THE MONTH

tion! QRA is Ken Boord, 948 Stewartstown Road, Morgantown, West Virginia, U.S.A. See YOU next month? . . . K.B.

(Continued on page 37)

CHANNEL 1

(Continued from page 1)

nal source" for UHF weak signal experiments) asked for (a) permission to reduce ERP to 19.9 kw. visual (now 234 kw.) and (b) establish on channel 17 a "Booster" to cover now shadowed Porterville, California. Porterville receives signals from some Bakersfield and Fresno stations, but no ABC programs. KLYD plans to build and operate a 2.55 kw. On Channel Booster to bring the first light of ABC programs to this estimated market area of 6,000 receivers.

MORE DATA — UHF "Semi-Satellite Service"

As announced by DXing Horizons in February, the FCC will soon be presented with a proposal from the Broadcast Bureau to "OK Semi-Satellite" UHF service as a means of bringing both quality network programming and "local-live broadcasts" to areas now without either. The satellites will operate between channels 14 and 70 and, we are told, with a maximum transmitter power of one kw. The satellite service will be a "high powered translator" installation in the sense the majority of the unit's operating hours will be spent merely "repeating programs" from an origination station. However to achieve "local television programming and encourage local advertising," the satellite will be allowed a percentage of total broadcast time per day to "drop away" the originating station's signal and create one of its own.

Source in Broadcast Bureau told DXH "it is entirely possible that if this type of service is adopted by the Commission the seven man board will do away with all existing UHF allocation tables and grant new applications on a lowest channel available basis."

Our source continued, "the new service will help many of the 'larger-small communities' to bridge the gap between a Translator and a full-fledged television station. IF the Commission accepts our recommendations and approves this service, we (the Bureau) would be ready to go within 30 days time."

DXing Horizons reader Edward Pelissier of Hermiston, Oregon reminds us that a form of "semi-satellite service" already exists in the northwest. Origination station is KIMA-29, Yakima which operates as semi-satellites KEPR-Pasco, KBAS-Ephrata and KLEW-Lewiston. KEPR often identifies with the phrase "the nation's first satellite TV station."

The Broadcast Bureau approach to the project however is thought to be one of "local ownership" for the semi-satellite and not by the originating station, as with the KIMA chain of four.

THE LAW IS FOR THEM THAT BELIEVE!

Well known provision in FCC Translator regulations which require that every licensed Translator (VHF or UHF) serve an immediate area may be taken to task between Washington, D.C. and Rehoboth Beach, Delaware.

Regulations read that Translator may not be used merely as a "repeater" or "relay station" to feed another Translator too far away from the origination station for off the air pickup.

In early February the Washington Post Company (licensee of WTOP-9, Washington) filed for these Translator stations, in this sequence:

- (1) CP sought for channel 81, Denton, Maryland to repeat WTOP. Power, 302 watts ERP.

- (2) CP sought for channel 75, Milford, Delaware to repeat channel 81, above. ERP 32.4 watts.
- (3) CP sought for Lewes-Rehoboth Beach, Delaware to repeat channel 75 above. Sought is channel 9 (where WTOP signal began!) with an ERP of 17.7 watts.

"A neat little relay system" commented an FCC party who is interested in the application's progress. Equipment specified is Adler, both VHF and UHF. Oh yes, Washington Post executives maintain several "summer beach houses" at Rehoboth Beach. Nice coincidence!

WHAT'S UP IN DALLAS

One executive of a "low power TV broadcasting equipment manufacturing firm" has been spending a good deal of time in Washington, D.C. of late. This may or may not have some bearing on a new application filed by the Electron Corporation, Dallas, Texas for a "commercial TV station" on channel 73 in Richardson, Texas. Application seeks "unlimited hours of operation, 2,008 kw. visual power and antenna height of 204 feet." Richardson is an "electronics suburb" of Dallas.

FCC DECIDES RHINELANDER, WISCONSIN CASE

As reported in the December, 1960 and January, 1961 issues of DXing Horizons an unpleasant battle has been underway for some time in Rhinelander, Wisconsin, between a local CATV system and the operator of four UHF Translator stations who admits he runs them for profit.

UHF operator J. R. Karban purportedly ran Translators as an adjunct to his TV service shop. This the FCC could swallow. However Karban allegedly negotiated contracts with nine TV repair and retail outlets in Rhinelander, restricting the sale and/or repair of UHF converters for residents who were not "subscribing" on a donation basis to Karban's Translators. FCC decided Karban had entered into the agreements with area TV shops to protect his investment but not with malicious intent. Karban can keep his UHF Translators, but his servicing-sales agreements on converters must go!

Original protestant to the case, Rhinelander TV Cable Co. did not appear at the hearing and was held in default.

POSSIBLE ANTENNA FOR VHF TRANSLATORS

The search for a suitable VHF Translator transmitting antenna built commercially and readily available has been over a long hard trail. Manufacturers of antennas apparently do not want to agitate their Cable TV customers by bringing out a Translator antenna. However the TACO Company, Sherburne, New York (manufacturer of a long line of quality ruggedized TV antennas) has a pair of models very suitable for the Translator job. Under the designation SY-41 and SY-42, the TACO antennas consist of a screen reflector with single (SY-41) or double (SY-42) dipole driven elements. Antenna provides very high front to back, excellent impedance matching and broader pattern than conventional yagi antennas. The SY-41 model starts at \$125.00.

The Lake Television Association, of Colorado recently amended their Form 346 to specify the TACO SY-41 antenna for their one watt unit. They rate their ERP at 5.74 watts.

VHF TRANSLATOR — UNDER \$500.00!

It's almost official now. The Mid America Relay System outfit, pioneer VHF Translator manufacturer from Rapid City, South Dakota, will be selling a one-third watt VHF Translator which meets all FCC requirements for unattended operation, etc. for under \$500. Unit will weigh less than five pounds and be housed in a box 6"x8"x12." Ruggedized industrial tube types will be used throughout. MARS "promised" the mountain states they would bring out such a unit as early as January 13, 1959 in a story in the Denver Post.

CATV — NOWACZEK NAMED AS SPECIAL ASSISTANT

Frank H. Nowaczek, Jr. has been named "special assistant" in the Washington, D.C. headquarters of the National Community Television Association. Nowaczek has been public relations manager of the NCTA since joining the Cable TV trade association in August, 1959.

NCTA MOVING

A moving day is just around the corner for the NCTA. Long housed in the Perpetual Building (on E street), the new larger NCTA offices will be housed in the well known Transportation Building.

CABLE COMPANY SEEKS TRANSLATOR PERMITS

Collier Electric Company, owner of a string of CATV systems in Colorado and Nebraska, as well as Wyoming, has filed for permits to repeat KTVR-2 (Denver) on channel 11 and KRMA-6 (Denver) on channel 13, to the Laramie, Wyoming region. Collier now carries channels 2, 4, 7 and 9 from Denver on its Laramie Cable system.

OTTAWA TV CABLE COMPANY... AND JERROLD

Downstate Illinois Ottawa TV Cable Company will soon be served by microwave signals from WBBM-2, WNBQ-5, WBKB-7 and WGN-9, all Chicago. Midwest Microwave, presently feeding the four Chicago signals to a Peru, Illinois, CATV system will install a power split at Norway, Illinois, to feed the new Ottawa expansion. Ottawa TV Cable Company is a new interest of Milton J. Shapp, President of Jerrold Electronics, Philadelphia.

NAB REVEALS APPROACH TO CATV

Charles H. Tower, TV Vice President for the National Association of Broadcasters spoke before the "Radio and Television Executives Society CATV Workshop" during late January, and told his audience "broadcasters and CATV operators must end their disagreements." Among five "key principals" he listed for "peaceful co-existence" between the two "not always friendly businesses" was this point.. (3) "It is essential to have legislation recognizing that CATV systems, if not a part of the nationwide allocations program, have at least a substantial impact upon it. Such legislation must give the FCC statutory authority it claims it does not now have to control, where necessary, the relationship between free television and existing CATV and also to control the possible future development of CATV."

If ever the CATV industry needed a "livewire knowledgeable ball of fire" at its head, it is now. We place the entire thorny problem onto the lap of new NCTA Executive President William Dalton and wish him the best of luck in bringing the

"CATV Image" up to the level a majority of CATV operators have long ago earned, but which somehow has been lost in the shuffle.

JERROLD OPENS NEW EXPANDED LAB

Jerrold President Milt Shapp presided over a dedication ceremony January 26 in Huntingdon Valley, Pa. at which he noted "the development of new products and innovations in techniques through private research provides a key factor in the expansion of private enterprise and thus the reversal of the present downward trend of the American economy." Jerrold's newly expanded Electronics basic research lab will be used in part for the company's expected entry into a series of allied fields.

RF MEASUREMENTS — NEW JERROLD VOLTAGE COMPARATOR

IRE Show-goers, March 20 through 23rd in New York City, will be treated to a look see at Jerrold's new Voltage Comparator, a device applying the concept of measurement by comparison (MBC) to laboratory and production line testing.



Model VC-12 (illustrated) features an accurately calibrated, variable two-mc rf signal which provides an rf reference voltage output variable from 1 millivolt to 12 volts.

NEW BENCO STANDBY VHF TRANSLATOR

Benco Television Associates, Ltd. of Rexdale, Ontario (U.S. distributor—Blonder Tongue Labs, Inc., Newark, N.J.) has released preliminary data on a new unit which they say will permit "unattended operation of their model T1 and T5 Translators for periods up to six months long." The first system of this type is now being installed at North Brattleford, Sask., Canada. It consists of a main and standby transmitter plus sensing units which continuously monitor the picture and sound carriers at the output to the antenna.

If, for any reason, trouble develops on the main transmitter the standby unit is automatically put on the air and the main transmitter switched off.

As a further safeguard, the standby unit is energized for a five minute period each day, to allow the operator to check it out from a receiving location, should a need arise for its immediate and sudden use.

The unit is expected to be of great importance to Translator operators who must now pass by "excellent-high" but normally inaccessible sites with "normal" Translator equipment. Conceivably, only power or antenna failure can put the station off the air.

AT FADE-OUT

(Continued from page 34)

LAST MINUTE FLASHES—BBC, 6.015, Rangoon, hrd w-relay of BBC mx prgm 1430-1500; N-E 1500, prgm preview 1513, s-off 1515. (Riggs, Calif.) . . . CONGO (THE)—Leopoldville, 11.755, DEFINITELY hrd now to N. Am. 0000-0230A w-N-E 0045; hrd to Eur. w-N-E 2145, s-off 2300A. (Balbi, Calif.) . . . GHANA—GBS, 9.640, Accra, s-on 0700 w-N-E by GBS (NOT frm BBC); strg now dly, FORMERLY hrd SUN ONLY. (Balbi, Calif.) . . . ITALY—RAI, 9.575, Rome, hrd 0900-0930, starting w-N-Fr., N-E 0920 to Afr., strg parallel 11.905 (fair). (Balbi, Calif.) . . . IVORY COAST—R. Abidjan, 11.820A, hrd in Fr. and mx 1812; man anncd in ENG. is using NEW 100-kw. xmtr, asked for rpts to Box 2261, Abidjan; s-off 2330A; mostly in Fr. (Rowell, Minn.) . . . JAPAN—R. Japan will begin xmsns to Afr. in April. (Balbi, Calif.) Nihon SW BC Co., Tokyo, frm JUNE will operate JOZ, 3.925, all day 10 kw.; JOZ2, 6.055, JOZ3, 9.595, 50 kw. to 1100 (May-Aug.), to 1000 (Sept.-Oct., March-April), to 0900 (Nov.-Feb.); after those times to s-off w-10 kw.; now b-c DLY 2045-1545 on those 3 channels. (WRHB) . . . KOREA (NO.)—Accdg to sked frm stn, R. Pyongyang, 6.250, now has ENG. 0030-0100, 1230-1300. (Pearce, Eng.) . . . NIGERIA—Ibadan, 7.285A, hrd 0630 w-native mx, commercials in ENG.; S9 thru ham QRM. Nigerian hrd Feb. 15 at 0600-0730 on 6.185A may be the 6.049A one MOVED to this spot. (Saylor, Va.) . . . PAKISTAN—R. Pakistan, 7.275 (NEW fq), noted 1445-1500 w-N-E, parallel 11.672A. (Balbi, Calif.) . . . SARAWAK—R. Sarawak, 4.950, hrd w-mx 1445-1500; s-off 1502 w-“GSTQ.” (Riggs, Calif.) . . . SINGAPORE—R. Malaya, 7.200M, Singapore, noted in W. Va. at gud level 1130 when man ID in ENG., followed w-N-E; still readable 1230 recheck. (KBLP) FBS, 5.010, Singapore, hrd 1100-1145 strg; BBC N-E 1100, sports 1115; relay of BBCFES 1130; ID often; all-ENG. to 1300; s-off 1400; increased power? (Balbi, Calif.)

SHORTWAVE DXers—

Check page 27 for important publication bulletin concerning your subscription.

SOUTH AFRICA— ULTIMATE BCB DX

By RAY MOORE, Associate Editor

(Part One)

The two remotest corners of the world for the the Broadcast Band DX listener must be considered to be India and the Union of South Africa. There is a very good reason for the rarity of India reception in the United States as a signal from India must pass through the auroral absorption zone to reach any part of this country. But South Africa is different. There would seem to be an ideal all water path from our East Coast to Cape Town of about 7,700 miles. Yet reports of South African reception in the United States are extremely rare.

We will explore in this article the history of South African reception in this country, the reason why it has been so difficult, and the possibilities of better reception in the future.

In my opinion there are two reasons for the rarity of South African reception. Until recent years South African stations have operated on relatively low power and on relatively abbreviated schedules. In the past these schedules have always been such that it has been daylight at one end of the path or the other. When the stations signed on at 2330 EST it was already 0630 in Capetown and when the stations signed off at 2300 South African time it was only 1600 EST. Neither of these problems exist now.

HISTORY

Searching back through DX magazines and club bulletins from 1932 to date yields only a handful of instances of South African reception and some of these are rather sketchy.

1) Clyde Lowe, Merced, Calif., reported in the IDA's Globe Circler for January, 1935, "I received the Durban station at 8:48 to 9:32 P.M. EST. I've had ZTD (Durban) on four occasions but never as clear as on March 6th." The editor of the Globe Circler commented, "This ZTD veri has been inspected and is beyond a doubt authentic."

2) C. D. Streuber, Burbank, Calif., lists ZTC, Capetown, 1000 watts, as one of his best catches. No other details are known. This report was in Radex, April, 1935.

3) Dave Thomas, Ohio, listed as verification from ZTJ in the IDA Honor Roll during 1935. No other details are known.

4) C. M. Stansbury in Ontario reported three tentative loggings in 1952 and 1954, two of which resulted in verifications. In September, 1952 he logged a station on 1025 kc. and a tentative report was sent to Johannesburg and verified. The time of the reception was 2235 EST. In 1954 he received a QSL from Pietersburg on 989 kc. verifying a very tentative report. And on June 2, 1954, he reported logging Grahamstown on 674 kc. at 2305 EST through heavy QRN.

5) Reception of United States stations in South Africa was not at all uncommon in the 1930's, probably because neither the power nor time limitations applied to the reception in the opposite direction.

Next month, part two.

SALT LAKE CITY ... What a Conference

As this material is being compiled only days before we head east to the City by the Salt Lake, there is every indication that the DXing Horizons' sponsored first WESTERN TRANSLATOR CONFERENCE will be ONLY the first of many annual such affairs.

Manufacturers participating are gearing themselves for a series of "first showings" of new "under wraps" units for the VHF Translator field. One of these will be the Mid America Relay Systems one-third watt VHF Conversion Translator. MARS has dubbed their unit the MAC-10.

Late registrations include McIvor Parker of the FCC, Washington and a host of western Broadcasters from Amarillo and Wichita to Los Angeles and Anchorage! Unfortunately the March 3-4 weekend clashes with a series of "Network Affiliate" meetings held concurrently in New York. However most western broadcasting executives who are unable to attend because of the network sessions are sending down their "Chief Engineers" to represent the station.

Reports on the Conference will be published in the April and May issues of DXing Horizons-Television Horizons.

On a per call basis, tape recordings of the sessions will be available from DXing Horizons. The cost has not yet been determined, pending the quantity of orders. Those unable to attend who wish to have a "recorded transcript" are asked to contact DXing Horizons.

LINE FLASHES ...

The Booster bill has been killed in the Wyoming legislature. The Montana Bill appears to be going through.

Zenith will enter the Color TV market in the fall of this year. Details in April!

THE UHF HOME RECEIVING INSTALLATION

(Continued from page 9)

12-14 db across the UHF spectrum and some UHF tuner noise figures run as high as 20 db in the UHF Translator range (818-890 mc.)! To explain in terms of signal strength, when a VHF receiver produces a fair picture at a 50 uV level, the UHF receiver will need around 200 uV to produce the same quality picture! Not a pleasant thought. The best bet today is an outboard UHF converter of the type designed for UHF fringe areas. Either the Blonder Tongue BTU-2S or the Jerrold FTC models will perform well, if anything will produce a picture.

As both converters (and others on the market as well) have an IF output on channels 5 and 6 it is possible to add even additional IF gain in the form of a traditional VHF booster-preamp between the UHF tuner output and VHF set input.

A practical UHF Preampifier to go "ahead" of the UHF converter was described in the June DXing Horizons with building details.

(TO BE CONTINUED IN APRIL)

Report on McGee's SLC-Casper Meetings

... Held February 21-22

Senator Dale McGee (D-Wyo.) carried his inquiry into "western television reception" to Salt Lake City February 21 and Casper, Wyoming February 22. Accompanying McGee were FCC Commissioner Robert E. Lee and Senator Mock (D-Utah). In Salt Lake City a long line of VHF Booster operators told the trio they were most concerned over the one watt power limitation and the "newspaper advertising of applications" now imposed on Booster operators.

In Casper the meeting was televised from 9:00 to 11:45 over KTWO-2. In Casper, a long line of knowledgeable Booster operators spoke their piece. One of the first was Donald Bubar of the Laramie TV Club. Bubar was concerned over the "non-duplication" problems between Boosters operating in towns with local or nearby stations and the Boosters themselves. Bubar reported his TV Club had spent nearly \$3,000 for timing and shut down equipment to turn off the Laramie unit when "local" KFBC was carrying programs provided through the Booster outlet originating in Denver.

Marshall Macy of the Newcastle TV Club complained about the requirement that Booster operators print in a local newspaper notification of the intent to build or modify (see page 16, this issue DXH). Macy said "we have spent more than \$60.00 to advertise our intentions, and this is too much for limited capital groups."

Commissioner Lee countered with a promise that he would personally look into the matter in Washington and he felt confident he could have the requirement lifted for VHF Booster-Translators.

Newcastle operator Macy also complained about the identification procedure and suggested that the identification of the Translator be done by the "mother station" and not the Translator.

One of the best points taken was Macy's notice that under the present regulations, new Translator operators will not be able to experiment with improved transmitting antennas unless they file for a modification of their license.

Others appearing before the Committee were John Globe of Saratoga, Wyoming, who asked for more power; Darwin Hillsberry, Lee R. Johnson, Joe Sullivan and Otto Bohler of Douglas, Wyoming; Mildred Ernst of station KWRB-TV Thermopolis; Bill Groves of stations KFBC and KSTF; and Lawrence Berger of KTWO-TV.

A full report in April.

SHORTWAVERS ...

First Photos of Radio Swan Will Be in April DXH

It has taken eight months of constant work, but DXing Horizons has finally come through! Three illustrative photos are now in our hands of the Swan Island shortwave and medium wave outlet "Radio Swan." A special feature will appear in the April issue of DXing Horizons.

AVAILABLE FROM BLONDER-TONGUE

NEW BENCO LOW POWER TRANSLATOR

MODEL T-1

FCC TYPE ACCEPTED

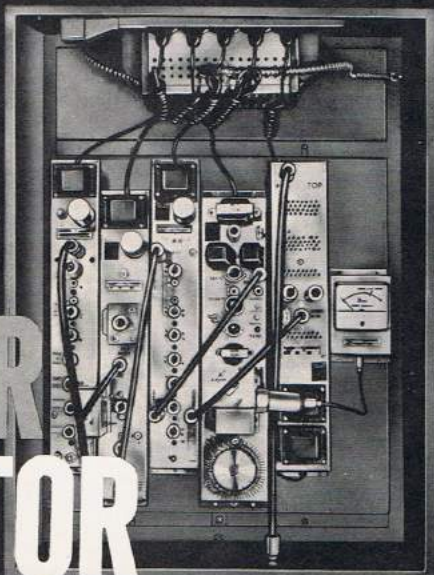

FEATURES STABLE OPERATION... MINIMIZES 'FALSE' SHUT-OFFS

The new Benco T-1 is the reliable way to increase coverage of existing TV signals. Engineered and manufactured by Benco (Canada) this new translator is now available through the Blonder-Tongue organization in the United States. The T-1 offers a host of advantages over other translators that can be summed up as long life and trouble-free operation, stable operation, foolproof automatic shut-off, and ease of maintenance. It is FCC type accepted.

MINIMIZES "FALSE SHUT-OFFS" CAUSED BY SIGNAL FADING—will not shut off unless the input signal from the remote master station falls below 10 microvolts for longer than 4 seconds.

FOOLPROOF AUTOMATIC SHUTOFF—When the master station goes off the air, this device turns off the transmitter. Ordinary shut-off systems work on the overall signal level. In weak signal areas, where a number of amplifiers must be used, noise generated in the amplifiers can be mistaken for the received signal and transmitted—even though the master station is off the air. The Benco Automatic Shut-Off can tell the difference between noise and the desired TV signal. It cuts off the transmitter anytime the 4.5 MC beat between the sound and picture carriers is missing. A time delay prevents cut off due to momentary signal fading.

PROVIDES STABLE OPERATION EVEN AT THE END OF POOR QUALITY POWER LINES—voltage regulating power transformer supplies the various units in T-1 with stable voltage. Eliminates stress on components caused by unstable supply voltages.

LONG LIFE AND TROUBLE-FREE OPERATION—full sized, underrated transmitting tube in output stage. Less stress on components due to stable operation.

EASY PERFORMANCE CHECKS—a built-in direct-reading power indicator checks power output; built-in test jacks for monitoring plate voltage and current of output tube.

RAPID SET UP OF CODING WHEEL OF IDENTIFICATION UNIT—The appropriate call letters for your area can be set up rapidly without need to cut copper contacts.

TECHNICAL SPECIFICATIONS

Translates input VHF channels to output VHF channels (2-13).

Primary power source	117 V \pm 20% 50 c/s
Power Consumption	150W
Temperature Ambient	-30°C to +50°C
Input	75 Ohms
Output	75 Ohms
Recommended input	50-2000 microvolts
Max. Permissible Power	1 Watt
Overall Noise Figure:	
Low Band	4 db \pm 1 db
High Band	6 db \pm 1 db
Frequency Stability02%
Gain:	
50 microvolts input to one (1) watt output	105 db
2000 microvolts input to one (1) watt output	73 db
Maximum gain	135 db
Band Width between Carriers	4.5 Mc (\pm 5 db)
Dimensions of Housing	35" x 28" x 10 1/2"
Weight	130 lbs.

for further details contact—

engineered and manufactured by

BLONDER-TONGUE

9 Alling St., Newark, N. J.

Canadian Division: Benco Television Assoc., Ltd., Toronto, Ontario. Export: Morhan Export Corp., New York 13, N. Y.
home TV accessories • UHF converters • master TV systems • industrial TV systems • FM-AM radio

HORIZONS UNLIMITED*

CATV BUYERS

CATV OWNERS

You Reach the Widest Range of Prospects through

DANIELS & ASSOCIATES, Inc.

PIONEER CATV BROKERS

EXCLUSIVE CATV BROKERS

BUYERS

- Let us show you investments with three to five years short term complete return of capital.
- Be on the ground floor for the expanding future in CABLE TELEVISION.
- Check with us for appraisals of existing systems.
- Let us outline an investment program in the field of CABLE TELEVISION.
- Management is no problem with our system of personnel selection and recommendation.

OWNERS

- Capital gains is often the only answer to depreciation problems.
- In selling you must contact the broadest possible market to obtain the best price.
- You gain the best advantage before selling by obtaining the appraisal of independent experts.
- Our job . . . to find buyers of competent ability and financial responsibility.

For discreet representation, sound advice and quick results — contact the CATV authority recognized throughout the United States and Canada. More than 90% of the CATV system sales to date, have been handled by DANIELS & ASSOCIATES, Inc.

DANIELS & ASSOCIATES, Inc.

BILL DANIELS CARL WILLIAMS ALAN HARMON FRED METCALF

The Daniels Building, 3rd Avenue and Milwaukee, Denver 6, Colo., Dudley 8-5888

Canadian Headquarters — — — 31 Quebec Street, Guelph, Ontario, TAYlor 2-2030

**Number five of a series. Massive experimental horn antenna during installation at the Florence Shoals, Alabama CATV system. This antenna, still in operation today, was designed for maximum rejection of co-channel interference in a region of the United States where overlapping signal areas cause frequent reception problems.*